

ePresentation Sessions

Saturday, May 23 2020

Ageing and dementia 1

EPR1001

A combined RS-EEG/RS-fMRI characterization of the prodromal phase of Alzheimer's disease

F. Agosta¹, G. Cecchetti², S. Basaia³, C. Cividini³, M. Corsi⁴, R. Santangelo⁵, F. Caso⁵, F. Minicucci⁴, G. Magnani⁵, M. Filippi¹

¹Neuroimaging Research Unit, Institute of Experimental Neurology, Division of Neuroscience, IRCCS San Raffaele Scientific Institute and Vita-Salute San Raffaele University, Milan, Italy, ²Neuroimaging Research Unit, Institute of Experimental Neurology, Division of Neuroscience; Neurology Unit; and Clinical Neurophysiology Unit, IRCCS San Raffaele Scientific Institute, Milan, Italy, ³Neuroimaging Research Unit, Institute of Experimental Neurology, Division of Neuroscience, IRCCS San Raffaele Scientific Institute, Milan, Italy, ⁴Clinical Neurophysiology Unit, IRCCS San Raffaele Scientific Institute, Milan, Italy, ⁵Neurology Unit, IRCCS San Raffaele Scientific Institute, Milan, Italy

Background and aims: The aim of this study was to evaluate electroencephalogram (EEG) performances alone or combined with resting state functional MRI (rs-fMRI) in order to characterize mild cognitive impairment (MCI) subjects with an Alzheimer's disease (AD)-like cerebrospinal fluid (CSF) biomarkers profile.

Methods: 39 AD, 86 MCI and 86 healthy subjects underwent EEG and/or rs-fMRI. MCI subjects were divided according to their CSF profile: those with phosphorylated tau/β-amyloid-42 ≥ 0.13 (MCI-ATpos) and those with the ratio < 0.13 (MCI-ATneg). Current source density (CSD) analysis was applied to EEG data at a lobar level. To combine the 2 techniques, networks mostly affected by AD pathology were identified using Independent Component Analysis applied to rs-fMRI data. Afterwards, EEG CSD and graph analyses were focused on these networks.

Results: AD showed an increase of delta and theta densities and a decrease of alpha2 and beta1 densities. MCI-ATpos showed higher theta density than MCI-ATneg patients. After the application of rs-fMRI networks to CSD analysis, alpha2 band distinguished MCI-ATpos patients from MCI-ATneg, AD and healthy subjects. Furthermore, at network level, graph analysis from EEG data did not show significant differences between MCI patients groups.

Conclusion: Theta frequency is the most sensitive to AD-like CSF biomarker profile. Furthermore, EEG/rs-fMRI integration highlighted the role of alpha2 band as neurodegeneration biomarker, correlating with disease progression.

Disclosure: Italian Ministry of Health (GR-2011-02351217).

EPR1002

Deep grey matter and hippocampal involvement in genetic cases of frontotemporal lobar degeneration

F. Agosta¹, E.G. Spinelli², A. Ghirelli², N. Riva³, S. Basaia², C. Cividini², G. Magnani⁴, F. Caso⁴, P. Caroppo⁵, S. Prioni⁵, L. Tremolizzo⁶, I. Appollonio⁶, V. Silani⁷, P. Carrera⁸, M. Filippi¹

¹Neuroimaging Research Unit, Institute of Experimental Neurology, Division of Neuroscience, IRCCS San Raffaele Scientific Institute and Vita-Salute San Raffaele University, Milan, Italy, ²Neuroimaging Research Unit, Institute of Experimental Neurology, Division of Neuroscience, IRCCS San Raffaele Scientific Institute, Milan, Italy, ³Unit of Neurorehabilitation, IRCCS San Raffaele Scientific Institute, Milan, Italy, ⁴Neurology Unit, IRCCS San Raffaele Scientific Institute, Milan, Italy, ⁵Unit of Neurology 5 - Neuropathology, Fondazione IRCCS Istituto Neurologico Carlo Besta, Milan, Italy, ⁶Neurology Unit, "San Gerardo" Hospital and University of Milano-Bicocca, Monza, Italy, ⁷Department of Neurology and Laboratory of Neuroscience, IRCCS Istituto Auxologico Italiano, Milan, Italy, ⁸Laboratory of Clinical Molecular Biology, IRCCS San Raffaele Scientific Institute, Milan, Italy

Background and aims: This study aimed to assess atrophy of deep grey matter (GM) and hippocampal structures using magnetic resonance imaging (MRI) in patients affected by disorders of the frontotemporal lobar degeneration (FTLD) spectrum with known genetic mutations.

Methods: 3D T1-weighted MRI sequences were obtained from 55 patients carrying mutations in the C9ORF72, GRN, TARDBP or SOD1 genes, including 38 with pure motor neuron disease (MND) and 17 with frontotemporal dementia (FTD). 57 age- and sex-matched healthy controls (HC) were also enrolled. GM volumes of the basal ganglia, thalami and hippocampi were obtained. MRI measures were compared between groups using ANOVA tests applying Bonferroni correction.

Results: The 32 patients carrying a C9ORF72 expansion were divided into two groups of 21 C9-MND and 11 C9-FTD. All 6 GRN-positive patients had an FTD clinical presentation, whereas patients showing TARDBP (n=10) and SOD1 (n=7) mutations had pure MND. Compared with HC, C9-MND patients showed atrophy of the bilateral pallidum, left caudate, and right hippocampus; C9-FTD patients showed atrophy in the same structures, as well as in the right caudate, right putamen, left thalamus and left hippocampus; GRN-FTD patients showed a severe involvement of all basal ganglia and bilateral hippocampi. TARDBP-MND and SOD1-MND patients showed GM volume values that overlapped with those of HC.

Conclusion: Our data suggest that measures of deep GM and hippocampal involvement might be useful markers of C9ORF72-related disorders, regardless of the clinical presentation within the FTL spectrum.

Disclosure: Supported by: Italian Ministry of Health (RF-2011-02351193; GR-2011-02351217) and European Research Council (StG-2016_714388_NeuroTRACK).

EPR1003

Longitudinal dynamics of mutant huntingtin and neurofilament light in Huntington's disease: the prospective HD-CSF study

F. Brogueira Rodrigues¹, L. Byrne¹, R. Tortelli¹, E. Johnson¹, P. Wijeratne², M. Arridge³, E. De Vita³, D.C. Alexander², S.J. Tabrizi¹, S. Schobel⁴, R. Scahill¹, A. Heslegrave⁵, H. Zetterberg⁵, E. Wild¹

¹Huntington's Disease Centre, UCL Queen Square Institute of Neurology, University College London, London, United Kingdom, ²Department of Computer Science, University College London, London, United Kingdom, ³Lysholm Department of Neuroradiology, National Hospital for Neurology and Neurosurgery, London, United Kingdom, ⁴Neuroscience, Ophthalmology, and Rare Diseases (NORD), F. Hoffman-La Roche Ltd, Basel, Switzerland, ⁵Department of Molecular Neuroscience, University College London, London, United Kingdom

Background and aims: Mutant huntingtin (mHTT) and neurofilament light (NfL) have emerged as leading biofluid biomarker candidates for Huntington's disease (HD). However, we lack robust data from repeated sampling of individual HD mutation carriers to define the longitudinal dynamics of these markers.

Methods: We quantified mHTT in CSF and NfL in CSF and blood at baseline and 24-months in the prospective HD-CSF study (20 controls, 20 premanifest HD, 40 manifest HD). We characterised longitudinal trajectories of each analyte using mixed effects models and their relationships with disease progression with partial correlations and linear regression. We computed clinical trial simulations to inform clinical trial design.

Results: mHTT in CSF and NfL in CSF and plasma all increased over time, had distinct patterns in HD mutation carriers compared with controls and increased in a manner dependent on HTT CAG count. We defined the age where each measure departed from normality for a given CAG count. The baseline value of each analyte predicted subsequent clinical progression and brain atrophy, better than rate of change in the analytes. Unlike baseline concentrations, rate of change in all analytes did not predict disease status. NfL would require fewer participants per arm than mHTT to run clinical trials as an outcome measure.

Conclusion: NfL is a stronger progression biomarker for HD than mHTT and could be used to inform clinical trial design. CSF mHTT nonetheless possesses prognostic value, and will remain an intrinsically valuable pharmacodynamic marker for huntingtin-lowering trials.

Disclosure: This work was funded by the Medical Research Council, CHDI Foundation, and F. Hoffman-La Roche AG

EPR1004

Biomarker counseling, disclosure of diagnosis and follow-up in patients with mild cognitive impairment: a European survey of EADC centers

K.S. Frederiksen¹, R. Nielsen², I. Appollonio³, D. Robinson⁴, L. Hausner⁵, B. Hanseeuw⁶, R. Perneczky⁷, T. Grimmer⁸, F. Nobili⁹, M. Olde Rikkert¹⁰, J. Hugon¹¹, A. Mendonça¹², N. Scarmeas¹³, S. Sloane¹⁴, T. Gabryelewicz¹⁵, P.-J. Ousset¹⁶, J. Hort¹⁷, O. Rouaud¹⁸, A. Gabelle¹⁹, K. Sheardova²⁰, L. Spuru²¹, A. Koivisto²², V. Jelic²³, I. Santana²⁴, G. Waldemar²⁵

¹Copenhagen, Denmark, ²Department of neurology, Danish Dementia Research Centre, Copenhagen, Denmark, ³MONZA (MI), Italy, ⁴St James' Hospital, Memory Clinic, Dublin, Ireland, ⁵Department of Geriatric Psychiatry, University Hospital of Heidelberg, Mannheim, Germany, ⁶Institute of Neuroscience, Brussels, Belgium, ⁷Department of Psychiatry and Psychotherapy, Technische Universität, Munich, Germany, ⁸Department of Psychiatry and Psychotherapy, Klinikum rechts der Isar of Technical University of Munich, Munich, Germany, ⁹Clinical Neurology, Department of Neuroscience (DINOEMI), University of Genoa, Genoa, Italy, ¹⁰Alzheimer Center, Nijmegen, Netherlands, ¹¹Paris, France, ¹²Faculty of Medicine, University of Lisbon, Lisbon, Portugal, ¹³Aiginio Cognitive Disorders center, University of Athens, Athens, Greece, ¹⁴Neuroprogressive Disorders and Dementia Network, Ninewells Hospital, Dundee, United Kingdom, ¹⁵Department of Neurodegenerative Disorders, Mossakowski Medical Research Centre PAN, Warsaw, Poland, ¹⁶Alzheimer's Disease Clinical Research Centre, Toulouse University Hospital, Toulouse, France, ¹⁷Prague, Czech Republic, ¹⁸Clinical neuroscience department, Vaud University Hospital Leenaards Memory Centre, Lausanne, Switzerland, ¹⁹Department of Neurology, Montpellier University Hospital, Montpellier, France, ²⁰International Clinical Research Center, St. Anne's University Hospital Brno, Czech Republic, Brno, Czech Republic, ²¹The Geriatrics-Gerontology and Old Age Psychiatry (Alzheimer Unit) Clinic, Carol Davila "University of Medicine and Pharmacy", Bucharest, Romania, ²²Kuopio, Finland, ²³Huddinge, Sweden, ²⁴Neurology, Centro Hospitalar e Universitário de Coimbra, Coimbra, Portugal, ²⁵Department of Neurology, Copenhagen University Hospital - Rigshospitalet, Copenhagen, Denmark

Background and aims: The concept of mild cognitive impairment (MCI) was developed for research to identify patients with objective cognitive impairment but not dementia. It has since diffused into clinical practice. The objective of the study was to assess practices regarding diagnostic procedure and disclosure including biomarker counselling in MCI.

Methods: The present study was designed as an online survey of medical doctors working in European Alzheimer Disease Centers.

Results: 34 center coordinating doctors out of 41 (80.9 %) and 110 out of 213 (50.6 %) individual doctors responded

to the survey. Almost all respondents had access to MRI (98.2%; n=108) and CSF (91.8%; n=101), whereas fewer had access to 18F-FDG-PET (74.5%; n=82) and amyloid PET (50.9%; n=56). Most respondents, always or usually discussed the decision to order biomarkers with patients with MCI (85.7%; n=90) and dementia (81.1 %; n=86). Nearly half (49.5 % n=54) of respondents found that the diagnosis of MCI was meaningful to a great extent, whereas this was 75.5 % (n=84) for dementia ($z=3.77$; $p=0.0002$). Almost all respondents reported always or usually following up MCI (95.2%; n=100) and dementia patients (90.48%; n=95). Half (50.5%; n=53) reported a follow-up period for MCI patients for 5 or more years and 45.3% (n=48) and reported following dementia for a similar amount of time.

Conclusion: Biomarkers are widely available, but that not all patients receive adequate biomarker counselling. For a considerable proportion of practices, we found considerable variability across centers. This may indicate that clinicians lack guidance on issues related to diagnostic disclosure including biomarker sampling.

Disclosure: Nothing to disclose

EPR1005

MAPT p.R406W carriers present with a nonconforming FTD phenotype in the Belgian Flemish population

H. Gossye¹, S. Van Mossevelde², J. Van der Zee¹, K. Peeters¹, L. Dillen¹, Y. Vermeiren³, A. Laureys¹, N. De Roeck³, P. Cras², S. Engelborghs⁴, P.P. De Deyn³, C. Van Broeckhoven¹

¹Center for Molecular Neurology, VIB-UAntwerp, Wilrijk, Belgium, ²Department of Neurology, Antwerp University Hospital, Edegem, Belgium, ³IBB, Antwerp, Belgium, ⁴Brussels, Belgium

Background and aims: The missense mutation, p.R406W in the MAPT gene, is a known causal mutation that was associated with frontotemporal lobar degeneration (FTLD) pathology and an atypical, Alzheimer’s disease (AD)-like clinical phenotype. In our Flemish-Belgian patient cohort, we identified 10 p.R406W carriers. Of 3 index carriers we sampled family members carrying the mutation, resulting in a cohort of 55 p.R406W carriers, to our knowledge the largest number. Our main aim was to analyse in detail their phenotypical and genetic characteristics.

Methods: From longitudinal follow-up over 19 years, we obtained data on clinical characteristics and neuropathology. We investigated the potential genetic modifying effect of the MAPT H1/H2 and the APOE genotypes on the phenotype.

Results: Of the 55 carriers 39 were patients. Allele and haplotype sharing analysis confirmed genetic kinship for all patients, suggesting the presence of a common ancestor. Average onset age and disease duration were 59.8 and 12.7 years (ranges 40-75 and 5-25). The most frequent diagnoses were dementia (unspecified) (43.6%), AD (28.2%) and behavioral variant frontotemporal dementia (bvFTD) (25.6%). FTLD-tau was diagnosed on neuropathology (n=1). A significantly shorter disease duration was found in carriers of at least one APOE ε4 allele (n=7) compared to carriers without (n=3).

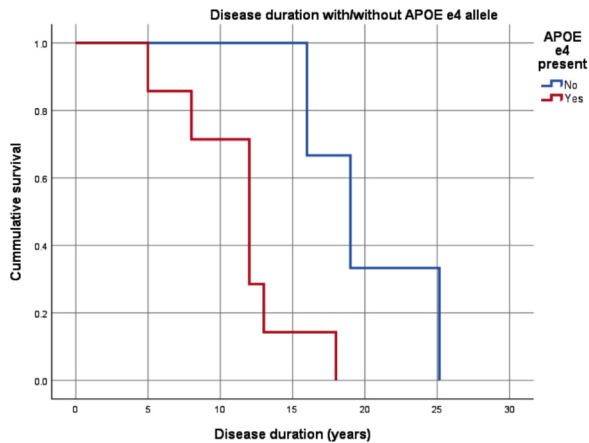

Figure 2. Disease duration with/without APOE ε4 allele.

	Neuropsychiatric symptoms					Cognitive symptoms				Other	
	Disinhibition, aggression	Apathy / inertia	Compulsive behavior, perseveration	Hyperorality / substance abuse	Depression	Hallucinations / delusions	Diminished executive functions	Memory problems	Disorientation		Pronounced language deficits
bvFTD (n=10)	100%	40%	50%	50%	30%	40%	20%	30%	30%	20%	20%
AD (n=14)	44%	22%	11%	11%	44%	22%	32%	100%	33%	11%	44%
D (n=1)	100%	50%	0%	0%	0%	0%	50%	50%	0%	0%	0%
MCI (n=1)	0%	0%	0%	0%	0%	0%	100%	0%	0%	0%	0%
All (n=22)	73%	32%	27%	32%	27%	18%	36%	32%	18%	14%	27%

Table 1. Most frequent early symptoms present in 22 affected MAPT R406W carriers with sufficient clinical data. Behavioral variant frontotemporal dementia (bvFTD), Alzheimer’s disease (AD), unspecified dementia (D), mild cognitive impairment (MCI), not available (NA).

Table 1. Most frequent early symptoms present in 22 affected MAPT R406W carriers with sufficient clinical data. Behavioral variant frontotemporal dementia (bvFTD), Alzheimer’s disease (AD), unspecified dementia (D), mild cognitive impairment (MCI), not available (NA).

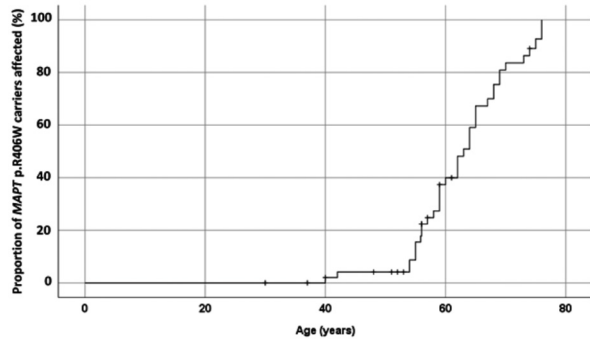

Figure 1. Risk liability curve for MAPT p.R406W mutation carriers.

Figure 1. Risk liability curve for MAPT p.R406W mutation carriers.

Conclusion: A nonconforming clinical phenotype of MAPT p.R406W carriers in the Flemish-Belgian cohort was observed with 25.6 % presenting with a clinical bvFTD phenotype. Prominent behavioral symptoms were highly frequent in the entire cohort (73%). The presence of an APOE ε4 allele shortened disease duration significantly.

Disclosure: Nothing to disclose

EPR1006

Long-term prognosis of cerebral amyloid angiopathy-related inflammation versus the typical type: worse or not?

G. Quesney¹, S. Coulette², M. Verdalle-Cazes³,
D. Renard⁴, M. Formaglio⁵, M. Quillard-Muraine³,
O. Martinaud⁶, O. Godefroy⁷, N. Olivier⁸, E. Magnin⁹,
J. Pariente¹⁰, N. Raposo¹¹, X. Aygnac¹², D. Wallon¹,
L. Grangeon¹

¹Neurology, Rouen University Hospital, Rouen, France,
²Neurology, Montpellier University Hospital, Montpellier,
France, ³Rouen University Hospital, Rouen, France, ⁴Nîmes,
France, ⁵Lyon Bron, France, ⁶CAEN, France, ⁷Neurology,
University Hospital of Amiens, Amiens, France, ⁸Perpignan
Hospital, Perpignan, France, ⁹CHRU Jean Minjot,
Besançon, France, ¹⁰Neurologie, CHU Purpan, Toulouse,
France, ¹¹TOULOUSE, France, ¹²Montpellier, France

Background and aims: Cerebral amyloid angiopathy-related inflammation (CAA-ri) is a rare entity of CAA, thought to be of poor outcome. To date, no study has assessed the long-term prognosis of CAA-ri compared to typical CAA

Methods: In a multicenter study, we retrospectively included all probable CAA-ri patients, according to Chung criteria from 13 French hospitals and a matched control cohort of typical CAA regarding gender and age at diagnosis (± 2 years). The clinical outcome was based on survival, disabilities and cognitive scales. Microbleeds (MBs), intra cerebral hemorrhage (ICH) and cortical superficial siderosis (CSS) were quantified on initial MRI as the Alzheimer CSF biomarkers when available.

Results: 48 CAA-ri patients (52% of males, mean age at diagnosis 73.3 years old) were compared to 48 typical CAA. The mean follow-up duration was 25 months in both groups. CCA-ri patients were more likely to present with worse MMSE (21.2 vs 24.2, $p=0.05$) and modified Rankin scale (2.9 vs 1.8, $p=0.008$) but the rate of death was similar. Mean MBs count was higher in CAA-ri patients (262.0 vs 60.1, $p=0.02$), but we observed less presence of ICH (14.5% vs 90.4%, $p<0.001$) and less CSS (14.5% vs 41.6%, $p=0.01$). In CSF, Tau protein was higher ($p=0.03$) in CAA-ri patients whereas A β 1-42 peptide was lower ($p=0.04$).

Conclusion: This largest CAA-ri study is the 1st showing worse long-term prognosis compared to typical CAA, with higher MBs on initial MRI and specific CSF biomarkers profile

Disclosure: Nothing to disclose

EPR1007

A long-term, retrospective diagnostic comparison of the amyloid, tau and neurodegeneration (A/T/N) classification with a clinical material of early Alzheimer's disease.

G.R. Grøntvedt¹, C. Lauridsen², G. Brathen¹, G. Berge³,
Ø. Salvesen⁴, L.R. White⁵, S.B. Sando⁵

¹Trondheim, Norway, ²Department of Neuromedicine and Movement Science, Norwegian University of Science and Technology, Trondheim, Norway, ³Institute of Neuromedicine and Movement Science, Norwegian University of Science and Technology, Trondheim, Norway, ⁴Unit for Applied Clinical Research, Faculty of Medicine and Health Sciences, Norwegian University of Science and Technology, Trondheim, Norway, ⁵Department of Neurology, INB, NTNU, Trondheim, Norway

Background and aims: The unbiased A/T/N classification is designed to characterize individuals in the Alzheimer continuum, and is currently little explored in clinical cohorts.

Aims: A retrospective comparison of the A/T/N classification system with the results of a 2-year clinical study, with extended follow-up up to 10 years after inclusion.

Methods: Patients (n=102) clinically diagnosed as AD with dementia or amnesic mild cognitive impairment (MCI), and 61 cognitively healthy control individuals were included. Baseline CSF core biomarkers for AD (A)

Results: A+T+N+ was a strong predictor for AD dementia, even among cognitively healthy individuals. Amnesic MCI was heterogenous, considering both clinical outcome and distribution within A/T/N. Some individuals with amnesic MCI progressed to clinical AD dementia within all 4 major A/T/N groups. The highest proportion of progression was among triple positive cases, but progression was also common in individuals with suspected non-Alzheimer pathophysiology (A-T+N+), and those with triple negative status. A-T-N- individuals who were cognitively healthy overwhelmingly remained cognitively intact over time, but in amnesic MCI the clinical outcome was heterogenous, including AD dementia, other dementias, and recovery.

Conclusion: The A/T/N framework accentuates biomarkers over clinical status. However, when selecting individuals for research, a combination of the 2 may be necessary since the prognostic value of the A/T/N framework depends on clinical status.

Disclosure: Nothing to disclose

EPR1008

Can routine gastrointestinal biopsies be used to assess eventual “preclinical” Parkinson’s disease.

J. Jotanovic¹, A. Terman², I. Alafuzoff³

¹Pathology, Uppsala University Hospital, Uppsala, Sweden, ²Pathology, Karolinska University Hospital, Stockholm, Sweden, ³Uppsala, Sweden

Background and aims: Parkinson’s disease (PD) is initiated years before the onset of characteristic motor symptoms. As the preclinical stage is difficult to identify, it is of great interest to develop biomarkers that would enable early diagnosis. The definite diagnosis is obtained post-mortem applying immunohistochemistry (IHC) to demonstrate α -synuclein (α Syn) pathology in the brain tissue. It is however known that α Syn pathology can be detected in peripheral nervous system, particularly in the gastrointestinal (GI) system, probably prior to brain involvement. The objective of this study was to assess whether GI samples obtained during life displayed α Syn pathology in subjects with post-mortem verified α Syn pathology in the brain.

Methods: During a 10-year period, 972 autopsies with a neuropathological assessment were carried out at Uppsala University Hospital. In 216 of the assessed brains α -synuclein pathology was observed. In 74 cases (34% of all cases with α Syn pathology), in addition to the brain, GI samples were available for this study. IHC method, applying four different antibodies was implemented on GI samples. A case was assigned as positive if labelled inclusions/neurites were observed in any of the tissue samples using any of the four antibodies.

Results: In 13.5% of the cases (10/74) clinical signs of PD were observed prior to death. In 92% (68/74) of all cases α Syn pathology was observed both in the brain and in the GI samples.

Conclusion: Our results indicate that assessment of α Syn in the GI biopsies can eventually be used as a diagnostic marker of α -synucleinopathy.

Disclosure: Nothing to disclose

EPR1009

Inhibitory synapse degeneration in Alzheimer’s disease: an array tomography study

H. Kurucu, D. King, M. Colom-Cadena, J. Rose, C. Davies, T. Spiers-Jones

Centre for Discovery Brain Sciences, The University of Edinburgh, Edinburgh, United Kingdom

Background and aims: Synaptic degeneration is the strongest correlate of cognitive impairment in Alzheimer’s disease (AD), although it is yet unclear to what extent inhibitory synapses are affected from the pathological process. Clinical findings on the other hand, suggest an excitatory/inhibitory imbalance from the very early stages. Array tomography is a high-resolution imaging method,

providing precise quantification of synapses in nanoscale. This study is the 1st to investigate inhibitory synapse degeneration in human AD brain.

Methods: Human brain tissues from BA20/21 and BA17 regions of 10 AD ((4F, 6M); (6 ApoE4+, 4 ApoE3+)) and 5 control (2F, 3M) cases (mean age \pm SD: 80.9 \pm 7.4 and 78.8 \pm 1.4, respectively) were stained with GAD65/67 antibody immunohistochemistry for inhibitory cell count; array tomography ribbons from the same regions were stained for DAPI, GAD65/67, synaptophysin and 6e10 antibodies for nuclei, inhibitory and total presynaptic terminals and amyloid plaques, respectively; and imaged with immunofluorescence to quantify synaptic densities around and away from plaques (Figure 1).

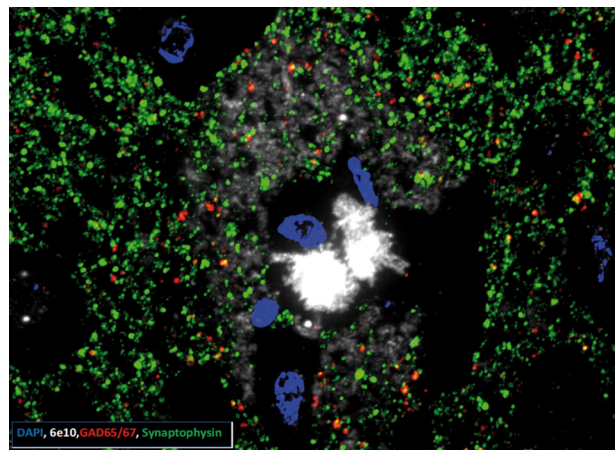

Figure 1: Image shows an amyloid plaque in the centre (6e10-white) surrounded by nuclei (DAPI-blue) and presynaptic terminals (Synaptophysin-green) and inhibitory presynaptic terminals colocalising with synaptophysin (GAD-red).

Results: Total GAD65/67+ cell count and GAD65/67 immunoreactivity was lower in AD in both brain regions. Cell numbers were the lowest in BA20/21 of ApoE4+ cases. Overall densities of GAD65/67+ presynaptic terminals were lower in both regions for AD, and plaque distance analysis showed a decrease in GAD65/67+ synapse densities in immediate surroundings of amyloid plaques.

Conclusion: Our results fall in line with previous studies showing lower GAD65/67 immunoreactivity in AD in temporal and occipital cortices. This effect was greater in ApoE4 allele+ cases. Inhibitory presynaptic terminals were decreased in general, and in a greater extent around amyloid plaques.

Disclosure: This study was funded by European Academy of Neurology under Research Training Fellowship funding scheme.

Autonomic nervous system disorders 1

EPR1010

Pain provocation during the tilt-table test in the diagnosis of reflex syncope

I. Adamec¹, A. Junaković¹, L. Crnošija¹,
M. Krbot Skoric¹, M. Habek²

¹Neurology, University Hospital Centre Zagreb, Zagreb, Croatia, ²University of Zagreb, School of Medicine, Zagreb, Croatia

Background and aims: To compare 2 tilt-table protocols in the evaluation of patients with transient loss of consciousness suggestive of reflex syncope.

Methods: Patients with a definite clinical diagnosis of reflex syncope were eligible for participation in the study and randomly assigned to 1 of the 2 tilt table protocols: A) The subjects were tilted to 70° for a maximum period of 10min. If there were no symptoms after initial 10min, a painful stimulus with the insertion of 0.7mm needle into the dorsum of hand subcutaneously for 30s was performed with patient tilted for further 30 minutes or until symptoms occurred; B) Standard 40min tilt without any provocation.

Results: Out of the 108 participants, 84 were assigned to protocol A (mean age 29.8±11.2, 66 females, median number of prior syncope 2) and 24 to protocol B (mean age 27.2±9.4, 18 females, median number of prior syncope 2). Syncope occurred more frequently in protocol A (66 (78.6%) participants) compared to protocol B (12 (50%) participants), p=0.009. There was no difference in timing of the syncope during the tilt test between the protocols (12 (range 3-37) in protocol A and 17.5 (range 1-37) in protocol B, p=0.181), however average duration of the tilt was significantly shorter for protocol A (13.5 (range 3-40) in protocol A and 38.5 (range 1-40) in protocol B, p=0.004).

Conclusion: The addition of painful provocation in the 10thmin of the tilt-table test increases the sensitivity of the test by 28%.

Disclosure: Nothing to disclose

EPR1011

Epidemiology of postural orthostatic tachycardia syndrome (POTS) in the population of Zagreb (Croatia)

I. Adamec¹, L. Crnošija¹, B. Ruska², T. Pavicic²,
A. Junaković¹, M. Krbot Skoric³, T. Pekmezovic⁴,
M. Habek⁵

¹Neurology, University Hospital Centre Zagreb, Zagreb, Croatia, ²Zagreb, Croatia, ³University Hospital Center Zagreb, Zagreb, Croatia, ⁴Belgrade, Serbia, ⁵University of Zagreb, School of Medicine, Zagreb, Croatia

Background and aims: We aimed to estimate the incidence of POTS in the population of Zagreb, Croatia and to determine demographic and clinical characteristics of the studied population.

Methods: Cases of POTS from 2012-2017 were identified by retrospective analysis of medical records in the University Hospital Center Zagreb. Crude incidence rates were standardized by age using the method of direct standardization according to the European and world standard population.

Results: From 385 patients referred as suspected POTS, 23 were identified as having a definitive diagnosis of POTS. The annual incidence ranged from 3.3 to 14.8 per 1,000,000 for both sexes combined. The highest incidence rates were registered in the age groups 18-29 and 30-39 with female predominance. The mean age at time of diagnosis was 30.7 (SD±9.2, range 18 to 52 years). The median duration of symptoms at time of diagnosis was 7.5 months (range 3 to 180 months). Regarding associated comorbidities, there were 2 patients with chronic gastritis and the following comorbidities were identified in 1 patient each: epilepsy, prior subarachnoid hemorrhage, anxiety, mitral insufficiency, obstructive sleep apnea, hypothyreosis and irritable bowel syndrome. In the group of patients not fulfilling criteria for POTS, the most common alternative diagnoses were autonomic dysfunction due to multiple sclerosis in 22, anxiety disorder in 17, epilepsy in 16 and orthostatic tachycardia due to deconditioning in 13 patients.

Conclusion: Data obtained in this study are useful in providing better surveillance of disease in population, comprehensive assessment of disease burden, and organization of health care services.

Disclosure: Nothing to disclose

EPR1012

Impact and Distribution of Autonomic Dysregulation in Fatal Familial Insomnia: Data from the Published Cases

L. Baldelli, G. Calandra-Buonaura, P. Guaraldi, P. Cortelli, F. Provini

Department of Biomedical and NeuroMotor Sciences (DiBiNeM), University of Bologna, Bologna, Italy

Background and aims: Fatal Familial Insomnia (FFI) is a hereditary prion disease linked to a missense mutation at codon 178 of the prion-protein gene (PRNP). FFI is characterized by physiological sleep loss and 24-hours autonomic and motor hyperactivation. Autonomic dysfunction consists in sympathetic overactivation with disruption of circadian rhythms and dysregulation of physiological responses. However, the impact throughout the disease course has been poorly investigated.

Methods: We reviewed all published cases of FFI genetically and/or pathologically confirmed until November 2019. We analysed the signs and symptoms of autonomic dysregulation including time of onset and domain involved, according to PRNP mutation genotype (MM, MV or unspecified).

Results: We comprehensively evaluated 136 cases from 61 different publications, 94MM, 19MV and 23 with an unspecified genotype. The mean disease duration was 11.68±5.14 months in MM patients and 22.33±12.91 months in MV (p<0.001). Thermoregulatory and cardiovascular domains were the most frequently involved (45.5% and 33.8% of patients respectively) without any significant difference between genotypes (Fig.1). Gastrointestinal symptoms, when present, appeared in more than 50% of cases within 3 months from disease onset (Fig.2). In relation to life expectancy, patients with breathing disturbances presented a reduction of 3.88 months (CI95%=-7.69--0.06; p=0.047); alteration of pupillary accommodation resulted in a loss of survival time of 8.97 months (CI95%=-14.24--6.69; p=0.004). Finally, a nightly non-dipper blood pressure profile reduced the survival by 10.0 months in MM patients (CI95%=-14.97--5.03; p=0.004).

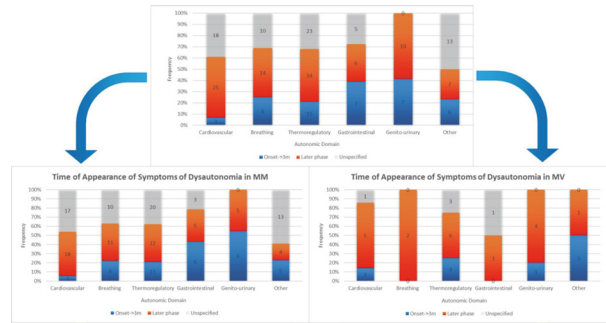

Correlation between symptoms of dysautonomia and time of appearance during the disease course in published cases of confirmed Fatal Familial Insomnia, homozygous (MM) and heterozygous (MV) at codon 129 as in Baldelli and Provini, 2019. The number of described cases has been indicated inside each column's section.

Conclusion: Dysregulation of specific autonomic domains leads to a marked reduction of life expectancy in FFI.

Disclosure: Nothing to disclose



Frequency of symptoms of dysautonomia throughout the disease course in published cases of confirmed (genetically and/or pathologically) Fatal Familial Insomnia, homozygous (MM) and heterozygous (MV) at codon 129 as in Baldelli and Provini, 2019. The number of described cases has been indicated inside each column's section.

EPR1013

Intensive rehabilitation of anomic aphasia is associated with beneficial autonomic effects by increasing parasympathetic autonomic modulation

C. De Rojas Leal¹, M.S. Dawid-Milner²,
M.C. Green Heredia³, M.L. Berthier⁴

¹Department of Neurology, Virgen de la Victoria Hospital, University of Málaga, Málaga, Spain, ²Neurophysiology of the Autonomic Nervous System Unit, Centro de Investigaciones Médico-Sanitarias, University of Málaga, Málaga, Spain, ³Department of Neuropsychology, Hospital Quirón, Málaga, Spain, ⁴Cognitive Neurology and Aphasia Unit (UNCA), Centro de Investigaciones Médico-Sanitarias, University of Málaga, Málaga, Spain

Background and aims: Anomic aphasia induces linguistic anxiety. Although the application of Constraint-Induced Aphasia Therapy (CIAT) (Pulvermüller et al., Stroke 2001;32:1621-6) has been proven to be effective in the treatment of anomic aphasia, its possible effect on cardiovascular autonomic modulation has not yet been studied. The objective of this study is to analyse whether the intensive rehabilitation of anomic aphasia has effects on cardiovascular autonomic modulation.

Methods: In 5 patients with chronic post-stroke aphasia (all men), we recorded RR-intervals (RRI) and continuous beat-to-beat blood pressure (BP) during a designation test of drawings (n=80) before and after 2 weeks (30 hours) of CIAT. We calculated parameters of total autonomic modulation [RRI standard deviation (RRI-SD)], mainly sympathetic cardiac modulation [RRI low frequency powers (RRI-LF-powers)], parasympathetic modulation [square root of the mean squared difference of successive RRIs (RMSSD) and RRI high frequency powers (RRI-HF-powers)] and sympatho-vagal cardiac balance (RRI-LF/HF-ratios). Values were compared before and after CIAT (paired t-test for normally distributed values; Wilcoxon-test for non-normally distributed values; significance: p<0.05).

Results: After CIAT, there was a significant increase in RRI-HF-powers (31.10±6.30 vs 39.04±10.64) and a significant decrease in RRI-LF-powers (68.74±6.34 vs 60.66±10.77) and RRI-LF/HF-ratios (2.32±0.71 vs 1.73±0.82). No significant differences were found in RRI, BP, RRI-SD and RMSSD.

Conclusion: CIAT has beneficial effects not only on anomic aphasia but also on cardiovascular autonomic modulation by increasing parasympathetic and decreasing sympathetic modulation, suggesting that intensive rehabilitation of anomic aphasia diminishes linguistic anxiety in aphasic patients.

Disclosure: Nothing to disclose

EPR1014

Exploring autonomous system during sleep: a key to understand sudden death in Prader Willi syndrome

R. Debs¹, G. Diene², C. Molinas², C. Julie¹,
M. Kermorgant³, M. Tauber², A. Pavy Le Traon¹
¹Neurophysiology, Toulouse University Hospital, TOULOUSE, France, ²Endocrinology, Toulouse University Hospital, TOULOUSE, France, ³INSERM, Toulouse University Hospital, TOULOUSE, France

Background and aims: Patients with PWS have a higher cardiovascular risk but the underlying mechanism is unclear, possibly related to autonomic nervous system (ANS) dysfunction.

Methods: 57 children performed a polysomnography: 37 PWS (7.2 years, sex ratio 1.05) and 20 controls (8.5 years, sex ratio 0.81). At the genetic level, there were 54% deletion, 43% maternal disomy and 3% imprinting defect. All patients were treated with GH for an average of 5.4 years. Sleep structure and Respiratory events were analyzed according to the criteria of the AASM 2012. The Heart Rate Variability has(HRV) been analyzed (Kubios software) in the time domain (SDNN, NN50 and RMSSD) and in the frequency domain (LF and HF).

Results: HR is significantly higher in patients PWS compared to controls in N2 and REM (trend only in N3). In the time domain, the RMSSD is significantly reduced at all stages of sleep and PNN50 is significantly reduced in N2 and REM (tendency only in N3). In the frequency domain, the LF power is decreased in N3 in the PWS group. HF power (reflection of parasympathetic tone) more low in the PWS group without being significant. The parasympathetic activity in PWS is altered as we notice a significant reduction in pNN50 and RMSSD and downward trend in HF (p=0.06). The decrease in potency of LF could reflect an associated decrease in sympathetic tone.

Conclusion: These changes in CV ANS regulation may contribute to the increase of cardiovascular risk in PWS, and thereby a lack of reactivity during nocturnal respiratory event. Additional studies are needed to deepen the mechanisms probably central mediation.

Disclosure: Nothing to disclose

EPR1015

Barriers and facilitators to implement the European Society of Cardiology syncope guidelines in five Dutch hospitals

M. Ghariq¹, L. Van Bodegom-Vos², M. Brignole³, J.G. Van Dijk¹, R.D. Thijs⁴

¹Leiden, Netherlands, ²Biomedical Data Sciences, Leiden University Medical Centre, Leiden, Netherlands, ³Ospedali del Tigullio, Lavagna, Italy, ⁴Department of Epilepsy, Stichting Epilepsie Instellingen Nederland (S.E.I.N.), Heemstede, Netherlands

Background and aims: Syncope is very common and has a broad differential diagnosis. Structuring syncope care abroad has been shown to improve diagnostic yield, reduce costs and improve quality of life. We implemented the European Society of Cardiology (ESC) 2018 syncope guidelines in 5 Dutch hospitals by changing procedures in Accident and Emergency (A&E) departments and establishing syncope units where none was present. We evaluated the implementation process to identify potential barriers and facilitators.

Methods: We conducted semi-structured interviews with 19 specialists and residents involved in syncope care from neurology, cardiology, internal medicine and emergency medicine. Interviews were audiotaped and transcribed in full. Reported barriers and facilitators were classified independently by 2 researchers according to the framework of Flottorp and analyzed with specific qualitative software (Atlas.ti).

Results: We identified 25 barriers and 18 facilitators. Most barriers concerned the individual health care professional, such as no experience of residents to work with the guideline at the A&E due to a high turnover, and the organizational context, e.g. no adherence to the guideline due to conflicting standardized procedures at the A&E. Most facilitators were reported at the level of innovation. The multidisciplinary syncope unit in particular was perceived as useful solution to a perceived need in clinical practice.

Conclusion: Implementing the ESC guideline on the A&E and starting syncope units facilitated a structured multidisciplinary work-up for syncope patients. Several barriers were identified in this study. Future implementation along similar lines can be improved by targeting these barriers.

Disclosure: This study was funded by the Netherlands Organization for Health Research and Development (843002707).

EPR1016

Disturbed microcirculation of the skin in patients with complex regional pain syndrome (CRPS)

J. Gierthmühlen, A. Sziegleit, J. Forstenpointner, R. Baron

Neurology, Division of Neurological Pain Research and Therapy, Kiel, Germany

Background and aims: Complex regional Pain Syndromes (CRPS) are characterized by autonomic, sensory and motor disturbances. The pathophysiology of CRPS involves beyond others disturbances of the sympathetic nervous system and chronic ischemia also seems to play a role. Non-painful warmth-induced vasodilation of the skin is regulated by an early CGRP (=nerval)-induced vasodilation followed by a delayed NO (=endothelium)-induced vasodilation. Both mechanisms can be investigated and differentiated by functional Laser-doppler Flowmetry (fLDF).

Methods: Skin perfusion of the affected and unaffected extremity of patients with CRPS and patients with unilateral pain syndromes of other origins were investigated fLDF (PeriScan PIM 3 System). The 1st measurement was made at rest after adaptation of skin temperature to 32°C. Afterwards, the skin was slowly warmed up to 42°C with a water-loaded ring for 25 minutes and skin perfusion monitored continuously.

Results: On the affected extremity all patients showed the typical bimodal vasodilation of the skin, whereat CRPS-patients showed a similar rapid increase of skin perfusion until the first peak (20.2 vs 21.1min, p n.s.), but a reduced amplitude of the 1. peak (80.1 vs 187.6PU, p<0.05), reduced dip between 1. und 2. peaks (53.4 vs 98.1PU, p<0.05) with similar duration (25.6 vs 24.6min; p n.s.) and a reduced skin perfusion with a slower rise (p<0.05) when approaching the plateau with an end of the measurement after 40 minutes (150 vs 232.1PU, p<0.05).

Conclusion: Results point towards a disturbed nerval- and endothelium-induced vasodilation in CRPS.

Disclosure: Nothing to disclose

EPR1017

Sudomotor dysfunction in people with neuromyelitis optica spectrum disorders

M. Habek¹, M. Andabaka², G. Brecl Jakob³, J. Drulovic⁴, A. Fanciulli⁵, F. Leys⁶, T. Pekmezovic², A. Junaković⁷, M. Krbot Skoric⁸, G.K. Wenning⁹, F. Deisenhammer⁵, T. Gabelic¹⁰, B. Barun¹, I. Adamec¹⁰, I. Lazibat¹¹

¹University of Zagreb, School of Medicine, Zagreb, Croatia, ²Belgrade, Serbia, ³Ljubljana, Slovenia, ⁴Clinic of Neurology, Faculty of Medicine, University of Belgrade, Belgrade, Serbia, ⁵Department of Neurology, Medical University of Innsbruck, Innsbruck, Austria, ⁶Innsbruck, Austria, ⁷Neurology, University Hospital Centre Zagreb, Zagreb, Croatia, ⁸University Hospital Center Zagreb, Zagreb, Croatia, ⁹Department of clinical Neurobiology, Medical University Innsbruck, Innsbruck, Austria, ¹⁰Zagreb, Croatia, ¹¹University Hospital Dubrava, Zagreb, Croatia

Background and aims: To analyze sudomotor function in people with neuromyelitis optica spectrum disorders (pwNMOSD).

Methods: We enrolled 41 NMO-IgG positive pwNMOSD (32 females, mean age 47.9±13.3, median EDSS 2.5, median disease duration 7 years) from Zagreb, Ljubljana and Belgrade. 27 patients had history of transverse myelitis, 30 optic neuritis and 7 area postrema/brainstem syndrome. Sudomotor function was evaluated with a validated questionnaire (COMPASS-31) and quantitative sudomotor axon reflex test (QSART). Sweat volumes were determined on 4 sites (hand, proximal and distal leg and foot) on the right side of the body and interpreted in the form of sudomotor index (SI) of Composite Autonomic Scoring Scale (CASS).

Results: Hypohidrosis and anhidrosis on the hand was present in 2 (4.9%) and 2 (4.9%), on the proximal leg in 4 (9.8%) and 4 (9.8%), on the distal leg in 2 (4.9%) and 5 (12.2%), and on the foot in 2 (4.9%) and 3 (7.35) pwNMOSD, respectively. Involvement of more than one site (hypohidrosis or anhidrosis) was present in 7 (17.1%) pwNMOSD. 2 participants reported reduced sweating in the COMPASS-31 questionnaire: 1 of them had hypo/anhidrosis on all sites, the other participant had normal QSART responses. The SI was pathological in 18 (43.9%) patients: sudomotor dysfunction was mild in 8 (19.5%), moderate in 6 (14.6%) and severe in 4 (9.8%) patients. Disease duration, EDSS, transverse myelitis or area postrema/brainstem syndrome were not associated with sudomotor dysfunction.

Conclusion: Sweating is frequently impaired in pwNMOSD, with up to 25% of patients showing moderate to severe sudomotor dysfunction.

Disclosure: Nothing to disclose

EPR1018

Cardiovascular autonomic testing in the work-up of cerebellar ataxia: insight from an observational single center study

E. Indelicato, A. Fanciulli, W. Nachbauer, A. Eigentler, M. Amprosi, J.-P. Ndayisaba, R. Granata, G.K. Wenning, S.M. Boesch

Neurology Department, Innsbruck Medical University, Innsbruck, Austria

Background and aims: Cerebellar ataxias are a heterogeneous group of disorders of both genetic and non-genetic origin. In sporadic cases, 2 entities are recognized: multiple system atrophy of cerebellar type (MSA-C) and SAOA (Sporadic Adult-Onset Ataxia). The presence of severe cardiovascular autonomic failure reliably distinguishes MSA-C from other ataxias, but it may appear only late in the disease course. Herein, we aimed at evaluating the diagnostic yield of cardiovascular autonomic function tests in the work-up of cerebellar ataxia.

Methods: We applied a cardiovascular autonomic tests battery in consecutive patients with neurodegenerative cerebellar ataxia and matched healthy control. We recorded the presence of both orthostatic hypotension (OH) and blood pressure falls non-fulfilling the criteria of OH (non-OH BP). Sporadic cases were followed-up for an eventual conversion to MSA-C.

Results: 42 patients were recruited, 19 of whom with sporadic disease (2 probable MSA-C, 6 possible MSA-C, 11 SAOA). Sporadic and hereditary cases showed no difference concerning ataxia severity at baseline. At head-up tilt, non-OH BP falls were detected in 9 patients, but not in controls. This finding was significantly more frequent in sporadic cases (p=0.006) and was detected in 5 out of 7 patients that during follow-up converted to possible/probable MSA-C. Findings at standing test were normal in 4 out of 9 cases with non-OH BP falls at head-up tilt.

Conclusion: A complete cardiovascular autonomic battery with head-up tilt can detect early signs of BP dysregulation which may be missed at bed-side tests, thus warranting its application in the first line work-up of cerebellar ataxias.

Disclosure: Elisabetta Indelicato was supported by an Austrian FWF I-3352-B28 grant.

EPR1019

Validation of the neurogenic orthostatic hypotension ratio upon active standing

K. Kerer¹, L. Weißmantel¹, F. Leys¹, R. Granata¹,
M. Perez², J.A. Palma², H. Kaufmann²,
L. Norcliffe-Kaufmann², K. Seppi¹, G.K. Wenning¹,
A. Fanciulli¹

¹Department of Neurology, Medical University of Innsbruck, Innsbruck, Austria, ²Department of Neurology, New York University School of Medicine, New York, USA

Background and aims: Distinguishing neurogenic orthostatic hypotension (nOH) from other causes of blood pressure (BP) instability is of pivotal importance in clinical practice. Norcliffe-Kaufmann et al. recently showed that when the ratio between the heart rate increase and the systolic BP fall after 3 minutes of passive head-up tilt (HUT) is <0.492 , this indicates nOH. Here we aimed at validating this nOH ratio with standard arm-cuff BP measurements upon active standing (AS).

Methods: We screened all patients who had undergone cardiovascular autonomic function testing at the Innsbruck Medical University between January 2008 and September 2019.

Results: We included 51 patients (27 with Parkinson's disease, 22 with multiple system atrophy) diagnosed with orthostatic hypotension either upon AS or HUT. 49 patients showed no BP overshoot after the Valsalva maneuver and were thus classified as having nOH. Out of these, 27 patients showed a systolic BP fall ≥ 20 mmHg in both the HUT and the AS and were considered for further analysis. The nOH ratio was <0.492 for 20 patients during HUT and for 19 patients during the AS. The sensitivity of the nOH ratio for neurogenic OH was therefore 74% upon HUT and 70% upon AS. The correlation between the nOH-ratio upon HUT and AS was strong ($\rho=0.86$, $p<0.001$).

Conclusion: A nOH ratio <0.492 evaluated with standard arm-cuff heart rate and BP measurements has a good sensitivity for nOH both upon HUT and AS. This ratio can be therefore used as bedside nOH screening measure, if no tilt-test facilities are available.

Disclosure: Nothing to disclose

Cerebrovascular diseases 1

EPR1020

Efficiency of rehabilitation after stroke:

A multifactor analysis

L. Akhmadeeva¹, A. Kireeva¹, A. Timirova²,
G. Bulyakova¹, D. Islimgareeva¹, A. Kutlubayeva¹,
B. Veytsman³

¹Bashkir State Medical University, Ufa, Russian Federation,

²Ufa Hospital No 21, Ufa, Russian Federation, ³School of
Systems Biology, George Mason University, Fairfax, USA

Background and aims: The high prevalence of strokes makes the rehabilitation after stroke an important task. To better allocate the resources we need to understand the factors influencing the efficiency of rehabilitation in different time periods. In the previous study (Akhmadeeva L. R. et al, Effectiveness of rehabilitation after stroke in the hospital: quantitative analysis of motor function recovery, Problems of balneology, physiotherapy, and exercise therapy, 2019, 40, p. 4-9) we compared patients in acute stroke unit and rehabilitation ward. This study discusses patients in the early rehabilitation state (first six months after the stroke)

Methods: N=548 in-patients, (320 males and 228 females) were studied in the rehabilitation wards of two hospitals in Ufa, Russia. The average age was 65.5 years, standard deviation 10.8. Hospital A staff participated in a long-term training program. Rivermead Index change and other parameters were measured. Power was >0.999 for medium effects ($r=0.3$) and 0.65 for small effects ($r=0.1$) (5% level).

Results: We found a significant improvement in the Rivermead index after rehabilitation. Gender, the duration of hospital stay or the time after stroke did not have noticeable effect on the outcome. The improvement at the hospital with the specially trained staff is 1.08 points higher than at the other hospital. Younger age, better initial state or ischemic (as opposite to hemorrhagic) stroke had small positive effects.

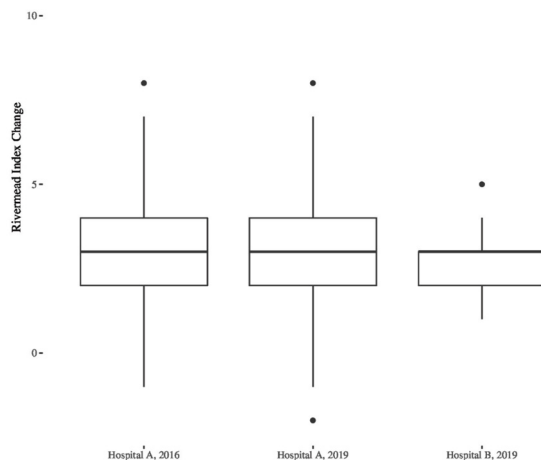

Figure 1: Average change in Rivermead Index

Average change in Rivermead Index

Table 1: Change in Rivermead Index for Different Hospitals

Hospital	Number of patients	Mean change	Standard deviation
Hospital A, 2016	104	3.11	2.29
Hospital A, 2019	410	3.11	1.93
Hospital B, 2019	34	2.76	1.13

Change in Rivermead Index for Different Hospitals

Table 2: Factors of patients' improvement

Factor	Change in Rivermead Index Improvement			p
	Mean	95% Interval		
		Min	Max	
Hospital B as compared to Hospital A	-1.0802	-1.8005	-0.3598	3.38×10^{-3}
Age (per year)	-0.0225	-0.0401	-0.0049	1.25×10^{-2}
Male sex	0.1345	-0.2295	0.4985	4.68×10^{-1}
Initial Rivermead Index	0.2208	0.1353	0.3062	5.67×10^{-7}
Days in rehab	0.0246	-0.0393	0.0885	4.50×10^{-1}
Ischemic stroke as compared to Hemorrhagic stroke	0.4745	0.0028	0.9462	4.87×10^{-2}
Days before rehab	-0.0004	-0.0036	0.0027	7.81×10^{-1}

Factors of patients' improvement

Conclusion: Rehabilitation is beneficial for all stroke patients. The effect of patients' age and initial state is quite small. Training of hospital staff is important for the rehabilitation.

Disclosure: Nothing to disclose

EPR1021

The association of paraoxonase-1 L55M single nucleotide polymorphism with recurrent ischemic stroke

D. Aksoy¹, N. Bozkurt², O. Sümbül², B. Çevik¹, S. Kurt¹, Ö. Ateş²

¹Neurology, Tokat Gaziosmanpaşa University Medical Faculty., TOKAT, Turkey, ²Medical Biology, Tokat Gaziosmanpaşa University Medical Faculty., Tokat, Turkey

Background and aims: Ischemic stroke patients are often at significantly increased risk of stroke recurrence, even despite appropriate treatment. In the studies it has been stated that HT, atrial fibrillation, transient ischemic attack, and male gender are primary risk factors in recurrent strokes. In atherosclerotic processes such as coronary artery disease and stroke, Paraoxonase-1 (PON1) L55M polymorphisms have been often investigated. The aim of this study is to examine PON1 L55M polymorphism in patients with recurrent atherothromboembolic stroke and determined its effects on risk of recurrent stroke.

Methods: 110 patients with atherothromboembolic recurrent ischemic stroke (48 females, 62 males), for whom we excluded the possibility of cardioembolism with proper examinations were included in this study. 84 patients without stroke from the same age group (35 females, 49 males) were included as the control group. Hypertension, diabetes mellitus, smoking, and LDL levels of the patients were recorded. The frequency of the PON1 L55M was examined in patients and controls using a Polymerase Chain Reaction and Restriction Fragment Length Polymorphisms method.

Results: After adjusting for age, gender, and the prevalence of smoking, hypertension, diabetes mellitus, and hypercholesterolemia, the MM genotype (MM vs. LL+LM) was found to be associated with a decreased risk of recurrence ($p=0.002$). These data results showed a significant correlation between the PON1 L55M polymorphism and recurrent ischemic stroke in terms of genotypic frequency distribution (Table).

	Patients n: 110	Controls n: 84	p	O.R. (CI 95%)
PON1 L55M			0.0022	
LL	86 [78.2%]	46 [55%]		
LM	19 [17.3%]	28 [33%]		
MM	5[4.5%]	10[12%]		
Allele frequency			0.000	2.63(1.57-4.44)
L	191[86.8%]	120 [71%]		
M	29 [13.2%]	48 [29%]		

Genotypic and allelic distribution of the PON1 L55M polymorphism among controls and recurrent ischemic stroke patients

Conclusion: The results of the present study suggest that PON1 L55M polymorphism may be one of many genetic factors for recurrent ischemic stroke susceptibility in Turkish population.

Disclosure: Nothing to disclose

EPR1022

Cognitive Impairment predicts stroke incidence and mortality: results from a population based study in an elderly Sicilian population

V. Arnao¹, M. Riolo², G. Salemi³, M. D'amelio³, P. Ragonese³, P. Aridon³

¹Neurology Department, Fondazione Istituto Giuseppe Giglio , Cefalu, Italy, ²BioNeC, University of Palermo, Palermo, Italy, ³BIND, University of Palermo, Palermo, Italy

Background and aims: Scanty population-based studies investigated predictors of cerebrovascular disease risk and mortality. Aims of this population-based study were to determine the characteristics of patients with CVD and to identify predictors of stroke mortality.

Methods: A prospective population-based study has been performed in the elderly population of Bagheria, Sicily. Differences in patient characteristics, cognitive impairment, premorbid risk factors, and hospital investigations were analyzed by t test or Chi square where appropriate. Relative risk, and Kaplan-Meier analyses were performed to investigate the effect of determinants on stroke occurrence and mortality. Statistical analyses were performed using SPSS software version 18.

Results: During the 9-year follow-up period 176 individuals out of a total population of 19800 person/years developed a CVD. Risk for stroke was significantly higher among individuals affected by cognitive impairment (RR 1.7; 95%CI 1.3-2.1). BMI distribution showed a significantly different pattern between individuals who developed aCVD compared to the others (p for trend= 0.01). We also observed a significant association between male sex and a higher stroke related mortality compared to women (RR 1.22; 95% CI 1.1-1.4). K-M estimates showed a cumulative probability for stroke occurrence during follow-up higher among patients affected by cognitive impairment (log rank test $p<0.0001$). Survival estimates showed also a significant association for a lower survival among individuals with a stroke having a cognitive impairment compared to the others ($p<0.0001$).

Conclusion: Findings of this study suggest that CI and BMI are associated with CVD occurrence and mortality displaying gender differences.

Disclosure: Nothing to disclose

EPR1023

The predictive value of collateral score in posterior circulation stroke

S. Bhaskar, Z. Calic

Department of Neurology and Neurophysiology, Liverpool Hospital, Ingham Institute for Applied Medical Research and The University of New South Wales (UNSW) Sydney, Sydney, Australia

Background and aims: Posterior circulation collateral score (PC-CS) is a quantitative grading tool to assess the status of collateralisation on computed tomography angiography (CTA). The study sought to examine the prognostic value of PC-CS to predict clinical outcome in patients with posterior circulation stroke.

Methods: Consecutive fifty-one patients with posterior circulation stroke with mean age 67.68 ± 13.84 years were retrospectively reviewed. The status of collaterals was graded using PC-CS assessed on a 10-points scale that quantifies the potential of collateral flow in posterior communicating and cerebellar arteries on pre-treatment CTA. PC-CS was dichotomised into poor (PC-CS: 0-6) and good (PC-CS: 7-10) collaterals. Association of collateral status with clinical outcome at 90 days (assessed using modified Rankin score (mRS)) was studied (poor outcome $mRS > 2$; good outcome $mRS 0-2$).

Results: Twenty-four patients (47%) had poor (PC-CS: 0-6) and 27 patients (53%) had good (PC-CS: 7-10) collaterals. In a multivariate regression model, poor (PC-CS: 0-6) collateral status (OR 28.3, CI 3.5-229.1) was significantly associated with poor outcome ($mRS > 2$) when adjusted for time to emergency presentation since stroke onset, treatment (thrombolysis and/or thrombectomy) and stroke severity at admission.

Conclusion: The pre-treatment collateral status assessed using PC-CS is an independent predictor of clinical outcomes at 90 days in posterior circulation stroke.

Disclosure: Nothing to disclose

EPR1024

Early neurological deterioration following thrombolysis for mild stroke with isolated internal carotid artery occlusion: incidence, predictors and mechanismsN. Boulenoir¹, P. Seners¹, J.-C. Baron¹, G. Turc²,
On Behalf Of The Minor-Stroke Collaborators³

¹Psychiatry and Neurosciences, Hôpital Sainte-Anne, Paris France, ²Neurology, Sainte Anne Hospital, Paris, France, ³France

Background and aims: The incidence, predictors and mechanisms of early neurological deterioration (END) following intravenous thrombolysis (IVT) for acute stroke with mild symptoms and isolated internal carotid artery occlusion (ICAO) are little known.

Methods: From a multicenter retrospective database we extracted all patients with both $NIHSS < 6$ and isolated ICAO (i.e. not involving the circle of Willis) on admission, intended for IVT alone (i.e. including those receiving rescue thrombectomy). END was defined as ≥ 4 NIHSS point increase within the first 24hrs. END and no-END patients were compared for i) pre-treatment clinical and imaging variables including occlusion site, completeness of Willis circle and perfusion, and ii) presence of intracranial arterial occlusion or haemorrhage on follow-up imaging.

Results: Of the 74 included patients (mean age 64yrs, median NIHSS 3, supra-bulbar ICAO in 35%), 30% experienced END, of whom 63% received rescue thrombectomy. There was no occurrence of parenchymal haemorrhage on follow-up imaging, but new intracranial occlusion was present in 75% of END patients vs. 0% of no-END patients ($P < 0.0001$). Supra-bulbar ICAO was the only admission predictor of END after stepwise variable selection (OR=4.0; 95%CI 1.2-12.5; $P=0.017$). As compared to no-END, END was strongly associated with poor 3-month outcome ($mRS \leq 1$: 71% vs. 20%, $P < 0.0001$).

Conclusion: END is a frequent and highly deleterious event after IVT for minor stroke with isolated ICAO. This study identified distal embolism as underlying mechanism in 3 out of 4 patients. The strong association with ICAO site may reflect a different response of the thrombus to IVT, which may depend on underlying stroke etiology.

Disclosure: Nothing to disclose

EPR1025

Predictors of outcome in 1-year survivors of large middle cerebral artery infarcts treated by decompressive hemi-craniectomy.

B. Casolla¹, M. Kyheng², G. Kuchcinski³, J.-P. Lejeune⁴, R. Hanafi³, M. Bodenant¹, D. Leys¹, J. Labreuche², E. Allart⁵, M. Jourdain⁶, C. Cordonnier¹, H. Hénon¹

¹Department of Neurology, Stroke unit, Univ. Lille, Inserm U1171, CHU Lille, Lille, France, ²Department of public health, epidemiology and quality assessment unit, Univ. Lille, EA 2694, CHU Lille, Lille, France, ³Department of Neuroradiology, Univ. Lille, Inserm U1171, CHU Lille, Lille, France, ⁴Department of Neurosurgery, Univ. Lille, Inserm U1189, CHU Lille, Lille, France, ⁵Department of Neurorehabilitation, Univ. Lille, CHU Lille, France, Lille, France, ⁶Department of Intensive care, Univ. Lille, Inserm U 1190, CHU Lille, Lille, France

Background and aims: Decompressive hemi-craniectomy (DH) increases survival without severe dependency in patients with large middle cerebral artery (LMCA) infarcts. The objective was to identify predictors of 1-year outcome after DH for LMCA infarct in clinical practice.

Methods: We conducted this study in consecutive patients who underwent DH for LMCA infarcts, in a tertiary stroke centre. Using multivariable logistic regression analyses, we evaluated predictors of (i) 30-day mortality, and (ii) poor outcome after 1 year (defined as a modified Rankin scale 4 to 6) in 30-day survivors.

Results: Of 212 patients (133 men, 63%; median age 51 years), 35 (16.5%) died within 30 days. Independent predictors of 30-day mortality were infarct volume before DH (odds ratio [OR], 1.09 per 10 ml increase; 95% confidence interval [95%CI] 1.03 to 1.15), and midline shift 24 hours after DH (OR 2.31; 95%CI 1.01 to 5.30). The optimal cut-off to predict death at 30-days before DH was an infarct volume of 210ml or more. Amongst the 177 survivors at day-30, 77 (43.5%) had a poor outcome at 1-year. Independent predictors of poor outcome at 1-year were age (OR 1.08 per 1-year increase; 95%CI 1.03 to 1.12) and weekly alcohol consumption of 300g or more (OR 5.30; 95%CI 2.20 to 12.76), but not infarct volume.

Conclusion: In patients with LMCA infarcts treated by DH, stroke characteristics (infarct volume before DH and midline shift after DH) predict 30-day mortality, while patients' characteristics (age and excessive alcohol intake) predict 1-year outcome in 30-day survivors.

Disclosure: Nothing to disclose

EPR1026

Extending intravenous thrombolysis time window guided by CT Perfusion

A. Celdrán de Castro García, J. Gómez Corral, R. Sainz Amo, B. Baena Álvarez, S. García Madrona, A. De Felipe Mimblera, A. Cruz Culebras, R. Vera Lechuga, C. Matute Lozano, J. Masjuan Vallejo
Neurology, Hospital Universitario Ramón y Cajal, Madrid, Spain

Background and aims: Intravenous thrombolysis (IVT) beyond 4.5 hours from symptom onset is contraindicated. Recent clinical trials have suggested that IVT window may be extended in patients with favorable radiological findings on CT perfusion or MRI. We present our experience with IVT beyond 4.5 hours.

Methods: Retrospective analysis of prospective registry of patients treated with IVT within 9 hours from symptom onset selected by CT perfusion (RAPID software) at our comprehensive stroke center from January 2019 to December 2019. Clinical and radiological variables were collected.

Results: 14 patients were included, (65% were females; mean age 73±14.19). Median NIHSS was 9.5 (range 2-25). Infarct core volume was 13.2ml (range 0-109.86), volume of salvageable tissue was 32.16ml (range 0-103.83) and mismatch ratio determined by RAPID was 3.3 (range 1.9-9.3). CT angiography showed vessel occlusion in 11 patients. Time onset of symptoms to the beginning of alteplase was 319min (range 280-510). Alteplase dose used was 0.9mg/kg in 13 patients and 0.6mg/kg in 1. None of them presented intracranial or systemic hemorrhagic complication. At 3 months, 63.3% patients were independent (mRS≤2) and the median mRS was 1.5 (range 0-4).

Conclusion: In our experience, selecting patients for IVT beyond 4.5 hours guided by CT perfusion is safe and effective, and is associated with a good neurological prognosis at 3 months.

Disclosure: Nothing to disclose

EPR1027

Stress Hyperglycaemia Associated with Poor Functional Outcomes in Acute Ischaemic Stroke Patients treated with Intravenous Thrombolysis

C. Cheong¹, T.W. Yuen¹, J.K. Thet¹, I.Y. Lee¹, B.Y. Tan², C.H. Sia³, V.K. Sharma⁴, L.L. Yeo²

¹*Yong Loo Lin School of Medicine, National University of Singapore, Singapore, Singapore,* ²*Neurology, National University Hospital, Singapore, Singapore,* ³*Cardiology, National University Hospital, Singapore, Singapore,* ⁴*Neurology, National University Hospital, Singapore, Singapore*

Background and aims: Transient hyperglycaemia in the context of illness with or without known diabetes has been termed as 'stress hyperglycaemia'. This has been demonstrated to be associated with an increased risk of recurrent stroke in patients with a minor ischemic stroke or transient ischemic attack. We investigated the association between stress hyperglycaemia ratio (SHR) and clinical outcomes in acute ischaemic stroke patients undergoing recanalisation therapy with intravenous thrombolysis (IVT).

Table 1: Comparing High (SHR \geq 0.97) with Low Stress Hyperglycaemia Ratio (SHR<0.97) in Patients with Acute Ischaemic Stroke Undergoing Intravenous Thrombolysis

	High SHR (\geq 0.97, n=219)	Low SHR (<0.97, n=447)	Mean Difference/Odds Ratio (95% CI)	p-value
Age	67.9 (\pm 15.2)	63.5 (\pm 13.6)	4.5 (2.1 – 6.8)	<0.001
Gender (Male)	49.8%	68.0%	0.64 (0.53 – 0.77)	<0.001
Smoking	6.4%	18.3%	0.88 (0.83 – 0.92)	<0.001
Diabetes	23.7%	16.6%	1.09 (1.01 – 1.19)	0.026
Hypertension	66.7%	57.3%	1.28 (1.03 – 1.59)	0.020
Hyperlipidaemia	49.3%	45.9%	1.07 (0.91 – 1.25)	0.401
Atrial Fibrillation	20.8%	13.4%	1.12 (1.04 – 1.22)	0.002
Fasting Glucose (mmol/L)	8.6 (\pm 3.0)	6.0 (\pm 1.7)	2.6 (2.2 – 2.9)	<0.001
HbA1c (%)	6.2 (\pm 1.4)	6.3 (\pm 1.5)	-0.1 (-0.4 – 0.1)	0.233
Haematocrit	39.5 (\pm 6.0)	41.2 (\pm 5.4)	-1.8 (-2.7 – -0.8)	<0.001
NIHSS at onset	16.7 (\pm 7.4)	13.3 (\pm 7.0)	3.4 (2.3 – 4.6)	<0.001
Systolic blood pressure at onset (mmHg)	159.5 (\pm 24.3)	150.5 (\pm 23.7)	8.9 (5.1 – 12.9)	<0.001
Diastolic blood pressure at onset (mmHg)	85.4 (\pm 15.6)	82.1 (\pm 15.5)	3.3 (0.8 – 5.9)	0.010
Mortality	5.0%	1.8%	1.03 (1.01- 1.07)	0.019
Good Functional Outcome (mRS 0-2 at 90 days)	37.0%	62.6%	0.59 (0.51 – 0.69)	<0.001

Table 1

Methods: We examined 666 consecutive acute ischaemic stroke patients who underwent IVT in our centre between 2006-2017 and had glucose and HbA1c tested at admission. SHR was calculated by fasting plasma glucose (FPG) divided by HbA1c. Univariate and multivariate analyses were employed [modified Rankin Scale (mRS) 0-2 at 90 days].

Results: 361 patients (54.2%) had good functional outcomes. These patients were younger (60.7 ± 12.7 vs 70.0 ± 14.4 years, $p<0.001$), of male gender (70.7% vs 51.5%, $p<0.001$), had lower prevalence of atrial fibrillation (13.0% vs 20.7%, $p=0.008$) and lower SHR (0.88 ± 0.20 vs 0.99 ± 0.26 , $p<0.001$). Patients with higher SHR were older, more significantly associated with diabetes mellitus, higher mortality rates and worse functional outcomes at 90-days

(Table 1). On multivariate analyses, SHR remained independently associated with good functional outcomes (adjusted OR 0.26, 95%CI 0.11-0.63, $p=0.003$).

Conclusion: SHR is an important predictor of functional outcomes in patients with AIS undergoing IVT. Further studies are necessary to validate this finding and determine if it can be targeted as a potential treatment variable.

Disclosure: Nothing to disclose

EPR1028

The association between carotid atherosclerosis and the coronary artery calcification

B.-H. Cho

Korea University Anam Hospital, Seoul, Korea, Republic of

Background and aims: Carotid atherosclerosis and coronary artery calcification has been suggested as a predictor of future coronary artery disease. The association between carotid Doppler ultrasound (US) and coronary artery calcium score (CACS) has not been investigated. The purpose of this study was to investigate the association between the carotid artery atherosclerosis and CACS.

Methods: We retrospectively enrolled subjects who had both carotid US and cardiac computed tomography as part of health examinations from March 2007 to April 2019. Subjects were categorized into four groups according to CAC score as assessed by cardiac computed tomography: zero (0), low (1-99), intermediate (100-399), or high (≥ 400). Then, the presence of the carotid plaque and the mean of carotid intima-media thickness (IMT, mm) in each CAC score group was assessed.

Results: A total of 2,941 subjects (mean age: 55.0 \pm 9.9 years; percentage male: 65.4%) were included for analysis. Carotid plaques were detected in 1006 subjects (34.2%). The presence of carotid plaque and the mean IMT significantly increased as the CACS increased (21.4%, 46.3%, 68.1%, 79.9%, respectively, p for trend <0.001; 0.64 \pm 0.23, 0.74 \pm 0.33, 0.77 \pm 0.37, 0.83 \pm 0.42, respectively, p for trend <0.001). Multivariate logistic regression analysis showed CACS was an independent risk factor for the presence of carotid plaque (adjusted odds ratio = 3.18; 95% confidence interval = 2.63-3.83). Multivariable linear regression analysis showed the IMT increased as the CACS increased (β =0.076, p<0.001).

Conclusion: A high CAC score was associated with the presence of carotid plaque and the increased IMT.

Disclosure: Nothing to disclose

EPR1029

Long-term EEG monitoring for the detection of epileptic activity in the acute phase of stroke

S. Proesmans, S. Hödl, H. Janssen, D. Hemelsoet,

P. Boon, V. De Herdt*Neurology, Ghent University Hospital, Ghent, Belgium*

Background and aims: Stroke is a common cause of seizures, especially in the elderly population. However, the incidence, associated factors and influence on outcome of interictal epileptic discharges and subclinical electrographic seizures in the acute phase of stroke are unknown.

Methods: In this prospective study, 55 patients underwent long-term video-EEG monitoring within 3 days after intracerebral haemorrhage or ischemic stroke. Epileptic activity on the EEG, including spikes, spike-waves and electrographic seizures, was analysed and correlated with clinical and neuroradiological patient characteristics, the occurrence of clinical seizures and functional outcome.

Results: Data analysis is ongoing. In a preliminary analysis, data of the first 35 patients was investigated. Epileptic activity was seen on the EEGs of 8/35 (23%) patients. 3/35 (9%) of patients had electrographic seizures, and spikes or spike waves were seen in 6/35 (17%) of subjects. Ictal electrographic activity and early clinical seizures (<7 days post-stroke) were significantly correlated (p=0.018) in patients with ischemic stroke. No other significant associations were found between the occurrence of epileptic discharges and clinical or radiological features, nor with outcome.

Conclusion: Data analysis of all patients is ongoing and will be presented for the 1st time at the conference. In a preliminary analysis of the first 35 patients, epileptic discharges were frequently found in the acute phase post-stroke. Ictal electrographic activity was associated with the occurrence of early clinical seizures.

Disclosure: Nothing to disclose

EPR1030

Neural progenitor cell-derived extracellular vesicles induce neuroprotection via regulation of the multidrug resistance transporter ABCB1 after ischemic stroke

L. Zhang¹, X. Zheng¹, I. Graf¹, J. Gronewold², M. Bähr¹,
T. Döppner¹

¹Neurology, University of Göttingen, Göttingen, Germany,

²Essen, Germany

Background and aims: Extracellular vesicles (EVs) derived from neural progenitor cells (NPCs) enhance post-stroke neurological recovery, albeit the underlying mechanisms remain elusive. In light of previous research describing an enhanced post-stroke integrity of the blood-brain barrier (BBB) upon systemic transplantation of NPCs, we wondered whether or not NPC-derived EVs affect BBB stability and which cellular mechanisms might be involved in the process.

Methods: Using an in vitro model of brain endothelial cells (ECs) and astrocytes, cells were treated with EVs or PBS and exposed to oxygen-glucose-deprivation (OGD) injury. The readout parameters focused on the expression of ABCB1, an ATP-binding cassette (ABC) transporter expressed on ECs contributing to BBB integrity. Further in vitro analysis examined the pro-inflammatory NF- κ B pathway, the paracellular permeability and the transcellular electrical resistance (TER) of cultured ECs. In vitro data was finally confirmed using a rodent stroke model.

Results: Cultured ECs displayed increased ABCB1 levels when exposed to OGD, which was reversed by treatment with EVs. The latter was due to an EV-induced inhibition of the NF- κ B pathway. Using a BBB co-culture model of ECs and astrocytes exposed to OGD, EVs stabilized paracellular permeability and ABCB1 levels without affecting TER. Likewise, EVs yielded reduced Evans blue extravasation, decreased ABCB1 expression as well as an inhibition of the NF- κ B pathway and downstream matrix metalloproteinase 9 activity in stroke mice. EV-induced inhibition of the NF- κ B pathway finally resulted in a post-stroke modulation of immune responses.

Conclusion: EVs enhance post-stroke BBB integrity via ABCB1 transporter regulation attenuating inflammatory cell recruitment via inhibition of the NF- κ B pathway.

Disclosure: Nothing to disclose

EPR1031

Cancelled

Cerebrovascular diseases 2

EPR1032

Endocan: a novel predictor of endothelial dysfunction in silent brain infarction

Y. Erdal¹, N. Yavuz¹, O. Oguz², U. Emre¹

¹Department of Neurology, Istanbul Training and Research Hospital, Istanbul, Turkey, ²Department of Biochemistry, Istanbul Training and Research Hospital, Istanbul, Turkey

Background and aims: Silent brain infarction (SBI) has been proposed as a subclinical risk factor for symptomatic stroke in the future. In this study, we aimed to investigate the relationship between serum inflammatory markers and SBI.

Methods: We included 54 patients diagnosed with SBI as the study group and 52 individuals as the control group. SBI was defined as hypointense area on T1 and hyperintense on T2-weighted images sized >3mm diameter. The levels of endocan, PTX-3 and CRP in plasma were evaluated.

Results: The mean age (53.8±7.1 vs 52.5±8.5 years, p=0.527) and gender distribution (female/male, 39/15 vs 38/14, p=0.921) were similar between patient and control groups, respectively. Serum levels of endocan (p=0.036) and hsCRP (p=0.022) were significantly higher in patients with SBI than the controls. PTX-3 sedimentation, WBC, lymphocyte, monocyte, neutrophil, platelet, LDL, HDL, TG values were not significantly different between the groups with and without SBI (p>0.05). There was a significant correlation (p=0.16/r=-0.196) between hsCRP and endocan levels in the SBI group.

Conclusion: Endocan, a new biomarker of endothelial pathology, is significantly increased in patients with SBI and may predict future events of stroke.

Disclosure: Nothing to disclose

EPR1033

Platelet-to-lymphocyte ratio correlates with hemorrhagic transformation and a worse outcome at 90 days following stroke

D. Ferro¹, M. Matias¹, J. Neto², A. Lima³, B. Ferraz², G. Moreira⁴, E. Azevedo¹, P. Castro⁴

¹Neurology, Centro Hospitalar Universitário de São João, Porto, Portugal, ²Faculdade de Medicina da Universidade do Porto, Porto, Portugal, ³Departamento de Neurociências e Saúde Mental, Faculdade de Medicina da Universidade do Porto, Porto, Portugal, ⁴Stroke Unit, Centro Hospitalar Universitário de São João, Porto, Portugal

Background and aims: Inflammation has been associated with worse outcome in acute stroke. Platelet-to-lymphocyte ratio (PLR) is an inflammatory parameter that was associated with worse outcome in previous studies. In this study we evaluate the association between PLR, hemorrhagic transformation and functional independence at 90 days following stroke, in patients with ischemic stroke who received intravenous thrombolysis and/or mechanical thrombectomy.

Methods: We included patients with anterior circulation ischemic stroke who received revascularization therapy, between January 2017 and December 2018. We collected demographic, clinical, analytical and imagiological data. Hemorrhagic transformation was classified according to the Fiorelli criteria in H1, H2, PH1 and PH2+remote clot. The functional status was classified according to the modified Rankin scale (mRS). We further applied regression models to assess association between variables.

Results: 375 patients were included, 67% received intravenous thrombolysis and 61% were treated with mechanical thrombectomy. Hemorrhagic transformation occurred in 94 patients (25%). In the multivariate model, we found that higher levels of PLR were associated with greater hemorrhage severity, after adjusting for other variables (OR 1.34, 95% CI 1.05; 1.72). Lower PLR levels, on the other hand, were associated with functional independence at 90 days following stroke (p<0.01).

Conclusion: In this study, platelet-to-lymphocyte ratio was associated with hemorrhagic transformation and severity and worse functional outcome at 90 days. This is in line with previous studies which suggest that inflammation might be harmful in acute stroke. In the future, PLR might be useful in stratifying stroke patients in order to understand who may benefit from immunomodulatory therapies.

Disclosure: Nothing to disclose

EPR1034

Haematoma volume, secondary expansion and 3-month-mortality in patients on antiplatelet therapy. A systematic review and meta-analysis

M. Goeldlin, U. Fischer, D. Seiffge
 Department of Neurology, University of Bern, Inselspital,
 Berne, Switzerland

Background and aims: We aimed to assess the influence of prior antiplatelet therapy (APT) at onset of intracerebral haemorrhage (ICH) on hematoma characteristics and outcome.

Methods: We performed a systematic review and meta-analysis of studies comparing ICH outcomes of patients on APT (APT-ICH) with patients not taking APT (non-APT-ICH). Primary outcomes were haematoma volume (mean difference and 95%-confidence interval (95%-CI)), haematoma expansion, in-hospital- and 3-month mortality. Odds ratios (OR) were calculated with Maentel-Haenszel random-effects method and 95%-CI.

Results: Out of 1205 identified publications, 28 studies on 31,063 patients with APT-ICH and 62,789 patients with non-APT-ICH matched our in- and exclusion criteria. Patients on APT were older (6.8 years, 95%-CI 5.71 - 7.90, $p < 0.00001$, I^2 for heterogeneity = 69%, $p < 0.00001$), had larger haematoma volume (mean difference 3.6 ml, 95% - CI 1.43 - 5.28, $p = 0.0006$; $I^2 = 60%$, $p = 0.0009$), higher short-term-mortality (OR 2.02, 95%-CI 1.41 - 2.90, $p = 0.0001$; $I^2 = 76%$, $p < 0.00001$), higher 3-month-mortality (OR 1.5, 95%-CI 1.24 - 1.81, $p < 0.0001$; $I^2 = 70%$, $p = 0.0001$). Risk for haematoma expansion was insignificantly higher in APT-ICH (OR 1.26, 95%-CI 0.83 - 1.91, $p = .027$). We found insufficient data for comparison of single vs dual APT-ICH.

Conclusion: APT is a relevant risk factor for larger haematoma volume and higher mortality in patients with ICH. However, estimating the real-life impact remains difficult concerning the large heterogeneity amongst studies. Data on differences in single and dual APT-ICH are scarce and warrant further investigation.

Disclosure: MG has received a Young Talents in Clinical Research Grant by the Swiss Academy of Medical Sciences and the Bangert-Rhyner-Foundation

EPR1035

Ischemic stroke in young adults: retrospective cohort study in Republic of Moldova's tertiary neurology center

O. Grosu¹, I. Moldovanu², S. Odobescu², L. Rotaru²,
 G. Corcea², V. Simon³

¹Neurology, Nicolae Testemitanu State University of
 Medicine and Pharmacy and Diomid Gherman Institute of
 Neurology and Neurosurgery, Chisinau, Moldova,

²Neurology, National Institute of Neurology and
 Neurosurgery, Chisinau, Moldova, ³Neurology, Nicolae
 Testemitanu State University of Medicine and Pharmacy,
 Chisinau, Moldova

Background and aims: Ischemic stroke in young adults is a rising health problem with multiple risk factors and socio-economic impacts. The aim of the study was to characterize the cohort of Moldovan patients.

Methods: Retrospective medical records evaluation of 1687 patients with ischemic stroke treated in tertiary neurology center from January 2018 till December 2019 was performed and 59 patients aged 50 and less were included. Was analyzed the risk factors profile, clinical presentation, neuroimaging, and comorbidities.

Results: The study cohort consists of 67.9% men and 32.1% women, mean age – 42.95±6.7. In 82.1% was the 1st-ever stroke and 17.9% - recurrent. The middle cerebral artery territory was affected by 76.8%, mostly in the left hemisphere – 46.4% and posterior territory – 19.6% with brainstem location in 12.5%. The first clinical presentation was motor deficit – 60.7%, speech impairment – 23.2%. NIHSS 10.03±5.14. Neuroimaging shows: ischemic lesion – 94.6%, concomitant lacunar infarcts/leukoaraiosis – 28.6%, old strokes – 19.6%. Large vessel occlusion was documented in 12.5% (left side – 75%), stenosis – 30.4% (mean 43.5±15.7%) and vertebral artery hypoplasia – 25%. In 55.4% of patients, the sedimentation rate was elevated and in 26.8% - leukocytosis. Only 41.1% of patients were on anterior treatment and 7.1% had anticoagulants. In 26.8% patient different types of infection were documented prior to stroke onset. The risk factor profile is presented in table 1.

Nr.	Risk factors/comorbidities	% (abs)
1.	Hypertension	78.6% (44)
2.	Diabetes Mellitus	26.8% (15)
3.	Obesity	21.4% (12)
4.	Dislipidemia	33.9% (19)
5.	Atrial fibrillation	16.1% (9)
6.	Ischemic heart disease	8.9% (5)
7.	Large vessel atherosclerosis	32.1% (18)
8.	Smoking	17.9% (10)
9.	Alcohol	10.7% (6)
10.	Anterior C-V event	12.5% (7)
11.	Familial history of CV disease	17.9% (10)
12.	Infections	26.8% (15)
13.	Cancer	7.1% (4)
14.	Rheumatic heart disease	5.4% (3)

Conclusion: Moldovan cohort of young adults with ischemic stroke presents the same risk factor profile as older adults with the trigger role of infections in the stroke onset.

Disclosure: Nothing to disclose

EPR1036

T.E.D.R.A.S.- Trial: Transesophageal Echocardiography as Dysphagia Risk in Acute Stroke

S. Hamzic¹, T. Braun¹, M. Butz¹, H. Khilan², S. Weber², M. Yeniguen¹, M. Kaps¹, T. Gerriets¹, M. Juenemann¹
¹Neurology, University Hospital Giessen, Giessen, Germany, ²Neurology / Stroke Unit, Gesundheitszentrum Wetterau, Giessen, Germany

Background and aims: Dysphagia is common in patients with acute stroke and deteriorates the overall outcome. Transesophageal echocardiography (TEE) is routine examination in the diagnostics of stroke etiology. In cardiac surgery it is known as cause of postoperative dysphagia. The prevalence of dysphagia in acute stroke patients undergoing TEE is unknown. The aim of T.E.D.R.A.S. was to assess the influence of TEE on swallowing in acute stroke patients.

Methods: T.E.D.R.A.S., included 34 patients in 2 groups: 19 in the intervention group (IG), 15 in the control group (CG). Flexible endoscopic evaluation of swallowing (FEES) analyzed swallowing in the IG (1) one day before TEE, (2) max. 2-4 hours after TEE, (3) 24 hours after TEE. In the CG FEES was performed on 3 consecutive days with TEE after the last FEES. Validated scores assessed dysphagia severity. Difference scores were built from pre to post TEE for all dysphagia measures.

Results: In between group comparison dysphagia measures increased in the IG immediately after TEE and 24 hours after TEE in penetration-aspiration-score for saliva ($p < 0.001/p = 0.007$), for small liquid bolus ($p = 0.009/p = 0.059$) and for large liquid bolus ($p = 0.009/p = 0.025$). Secretion severity score is increased immediately after TEE and 24 hours after TEE in the IG ($p \leq 0.001/p \leq 0.001$) as well as the residue severity score for saliva, liquid boli and for puree.

Conclusion: The results of T.E.D.R.A.S. indicate that TEE has a negative influence on swallowing in acute stroke patients.

Disclosure: Nothing to disclose

EPR1037

Faster logistics of thrombolytic treatment in stroke centers with prenotification. Findings from a nation-wide survey in the Czech Republic.

M. Haršány¹, M. Bar², D. Černík³, R. Herzig⁴, R. Jura⁵, L. Jurák⁶, J. Neumann⁷, D. Sanak⁸, S. Ostrý⁹, P. Sevcik¹⁰, O. Škoda¹¹, D. Školoudík¹², D. Vaclavík¹³, A. Tomek¹⁴, R. Mikulík¹

¹Department of Neurology, St. Anne's University Hospital in Brno and Faculty of Medicine at Masaryk University, Brno, Czech Republic, ²Department of Neurology, University Hospital Ostrava and Faculty of Medicine at University Ostrava, Ostrava, Czech Republic, ³Comprehensive Stroke

Center, Department of Neurology, Masaryk Hospital Ústí nad Labem, KZ a.s., Ústí nad Labem, Czech Republic, ⁴Department of Neurology, Comprehensive Stroke Center, Charles University Faculty of Medicine and University Hospital, Hradec Kralove, Czech Republic, ⁵Department of Neurology, University Hospital Brno and Medical Faculty of Masaryk University, Brno, Czech Republic, ⁶Neurocentre, Regional Hospital Liberec, Liberec, Czech Republic, ⁷Department of Neurology and Stroke Centre, Krajská zdravotní – Hospital Chomutov, Chomutov, Czech Republic, ⁸Comprehensive Stroke Center, Department of Neurology, Palacký University Hospital, Olomouc, Czech Republic, ⁹Comprehensive Stroke Centre, Hospital České Budějovice, a.s., České Budějovice, Czech Republic, ¹⁰Department of Neurology and Stroke Centre, University Hospital Pilsen, Plzeň, Czech Republic, ¹¹Hospital Jihlava, Department of Neurology, Jihlava, Czech Republic, ¹²Center for Science and Research, Faculty of Health Sciences, Palacký University Olomouc, Olomouc, Czech Republic, ¹³Department of Neurology and Agel Research and Training Institute, Ostrava Vitkovice Hospital, Ostrava, Czech Republic, ¹⁴Department of Neurology, 2nd Medical School of Charles University and Motol University Hospital, Prague, Czech Republic

Background and aims: Acute ischemic stroke (AIS) patients with pre-hospital prenotification are treated faster with intravenous thrombolysis (IVT) than patients arriving to hospital without prenotification. However, it is not clear how much pre-hospital and in-hospital logistical steps contribute to the delay of thrombolytic treatment. We sought to investigate whether there are differences in in-hospital logistics of stroke centers with prenotification.

Methods: Logistical processes in Czech stroke centers from January 1st, 2017 to March 31st, 2018 were assessed by a questionnaire. Door-to-needle times (DNT) were obtained from SITS registry. The results of the study were analyzed by descriptive statistics.

Results: All 45 stroke centers in the Czech Republic responded. Due to one reorganization in 6 centers and 2 reorganizations in 2 centers, 55 center-datasets were analyzed. Prenotification was reported in 50 (91%) centers. Following differences between stroke centers with prenotification versus those without prenotification were found: median (IQR) DNT 26 vs. 40 (21-30 vs. 34-42) minutes, patients' admission to CT in 18 vs. 0 (36 vs. 0%) centers, admission to ER in 22 vs. 4 (44 vs. 80%) centers, admission to out-patient office in 10 vs. 1 (20% vs. 20%) center, no patients' transfers before IVT in 16 vs. 0 (32 vs. 0%) centers, and IVT initiation on CT table in 34 vs. 0 (68 vs. 20%) centers.

Conclusion: Stroke centers with prenotification had faster logistics of thrombolytic pathway. Prenotified AIS patients arriving to the hospital were more likely to be admitted to pre-prepared CT and have IVT initiated on CT table.

Disclosure: Supported by the project no. LQ1605 from the National Program of Sustainability II (MEYS CR).

EPR1038

Safety and efficacy of percutaneous transluminal angioplasty for atherosclerotic stenosis of vertebral artery origin

D. Krajíčková, A. Krajina, R. Herzig, V. Chovanec, M. Lojik, J. Raupach, O. Renc, O. Vyšata, L. Šimůnek, M. Vališ

Charles University Faculty of Medicine and University Hospital, Hradec Králové, Czech Republic

Background and aims: The aim was to find out how the presence of severe impairment of other cerebral feeding arteries and concomitant carotid artery stenting (CAS) affected the periprocedural risk and long-term effect of balloon angioplasties for atherosclerotic stenosis of vertebral artery origin (VAO).

Methods: We used a retrospective analysis of consecutive balloon angioplasties for $\geq 70\%$ VAO stenosis. The patients were divided into groups with an isolated VAO stenosis and multiple stenoses. We investigated the frequency of periprocedural complications in the 1st 72h and the risk of developing restenosis and ischemic stroke/transient ischemic attack (TIA) during the follow-up period.

Results: In the set of 66 patients aged 66.1 ± 9.1 years, concurrent severe polystenotic impairment was present in 56 (84.8%) patients. 21 (31.8%) patients received endovascular treatment for a stenosis on one or more other arteries in addition to VAO stenosis (15 of them had CAS). In the periprocedural period, none of the patients suffered from ischemic stroke or died. 1 case of TIA in the carotid artery territory (1.6%) occurred in the polystenotic group with concurrent CAS. During the mean follow-up period of 36 months, we identified 8 cases (16.3%) of $\geq 50\%$ asymptomatic VA restenosis. In addition, 4 (8.9%) cases of ischemic stroke occurred in the polystenotic group.

Conclusion: The presence of a severe polystenotic impairment or concomitant CAS had no adverse effects on the overall low periprocedural risk of balloon angioplasty of VAO stenosis or the risk of developing restenosis during the follow-up period.

Disclosure: Study was supported in part by the Ministry of Health of the Czech Republic (DRO – UHHK 00179906) and Charles University, Czech Republic (PROGRES Q40).

EPR1039

Risk of post-operative ischemic lesions after carotid endarterectomy and stenting

T. Hrbac¹, D. Skoloudik¹, V. Prochazka¹, D. Vaclavik²

¹Comprehensive Stroke Center, University Hospital Ostrava, Ostrava, Czech Republic, ²Stroke Center, Vitkovice Hospital, Ostrava, Czech Republic

Background and aims: Silent infarctions is frequently detected after carotid endarterectomy (CEA) or carotid stenting (CAS). Aim was to compare risk of new brain infarctions between CEA and CAS in 2 time periods.

Methods: All patients with ICA stenosis $>70\%$ indicated for CEA or CAS in 3 grant projects in 2 time periods (2004-2008 and 2014-2018) were included to the post-hoc analysis. Changes in the surgery (different plaque extraction technique and perioperative heparin dose) and stenting (different stent type, distal protection) were implemented in the 2nd time period. Brain diffusion-weighted magnetic resonance imaging (DW-MRI) was performed prior to intervention and 24h after intervention for new infarctions detection.

Results: 73 patients (47 males; age 64.9 ± 7.0 years) underwent CEA and 77 patients (58 males; age 65.6 ± 7.3 years) underwent CAS in the 1st time period (2004-2008); 247 patients (177 males; age 67.4 ± 7.5 years) underwent CEA and 121 patients (93 males; age 70.5 ± 7.6 years) underwent CAS in the 2nd time period (2014-2018). New infarctions were found after CEA in 18 (24.7%) patients in the 1st time period and in 37 (15.0%) in the 2nd time period ($p=0.05$). New infarctions were found after CAS in 38 (49.4%) patients in the 1st time period and in 34 (28.1%) patients in the second time period ($p<0.01$). New infarctions on control MRI were found more frequently in patients after CAS compared to CEA in both time periods ($p<0.01$).

Conclusion: Changes in the intervention techniques improve the risk of new brain infarctions after CEA/CAS. CEA had lower silent brain infarction risk compared to CAS.

Disclosure: Supported by the Ministry of Health of the Czech Republic grant No. NV19-04-00270.

EPR1040

In-thrombus Thrombin Activity in Acute Ischemic Stroke – New Diagnostic Marker of Cardio Embolic Origin

Z. Itsekson Hayosh¹, E. Abu Bandora¹, N. Shelestovich², M. Bakon², B. Khaitovich², S. Balan², J. Chapman¹, E. Shavit-Stein¹, D. Orion²

¹Sheba Medical Center, Te Aviv, Israel, ²Sheba Medical Center, Tel Aviv Yaffo, Israel

Background and aims: Identifying stroke subtype is essential for the 2ndary prevention of ischemic stroke, specifically differentiating cardio embolic from other causes. Histological profiling of clots retrieved by endovascular intervention has limited yield. This study measured for the 1st time thrombin secreted from retrieved clots.

Methods: Clots were retrieved from 68 patients with acute ischemic stroke that were classified by standard criteria into 18 patients with proven atrial fibrillation (AF), 15 patients with atherosclerotic origin and 35 with other, including cryptogenic causes). Standard samples from the clots were assayed for thrombin secretion and for general histology. A fluorescent substrate thrombin assay measured levels secreted from the clots every hour.

Results: Clots of AF origin secreted decreasing levels of thrombin with time in contrast to increasing levels of thrombin secreted by atherosclerosis origin thrombi ($p < 0.0001$ by repeated measures ANOVA). Using a summary measure of the ratio of thrombin secreted after 7/1 hours a diagnostic sensitivity of 100% and specificity of 73% were found for the present data. The group of cryptogenic stroke were indistinguishable from the AF group.

Conclusion: These results suggest thrombin secretion pattern from a clot may serve as a novel marker which will enable a fast, sensitive and specific diagnosis of stroke etiology thus providing an early and appropriate secondary prevention therapy.

Disclosure: Nothing to disclose

EPR1041

Early FLAIR Enhancement in Reversible Cerebral Vasoconstriction Syndrome

Z. Itsekson Hayosh, G. Tsarfati, G. Greenberg, M. Sharon, M. Bakon, A. Wohl, J. Chapman, D. Orion
Sheba Medical Center, Tel Aviv Yaffo, Israel

Background and aims: Reversible cerebral vasoconstriction syndrome (RCVS) is a relatively new clinical and neuro-radiological entity, with potentially devastating ischemic outcomes. No predictive marker for syndrome severity or ischemic outcome exists up to date.

Methods: In this retrospective cohort of 18 female patients admitted to an acute stroke unit in 2018-2019, we report an early MRI marker of posterior leptomeningeal enhancement in the absence of CSF pleocytosis.

Methods: In this retrospective cohort of 18 female patients admitted to an acute stroke unit in 2018-2019, we report an early MRI marker of posterior leptomeningeal enhancement in the absence of CSF pleocytosis.

Results: 12 out of 15 (80%) RCVS patients that underwent brain MRI exhibited this sign during the disease course. The degree of enhancement was scored and had shown a trend of positive correlation ($p = 0.04$, Pearson's correlation analysis, $R^2 = 0.3$) to RCVS severity depicted by radiological and clinical syndrome extent (number of affected vessels, ischemic stroke, seizure or subarachnoid hemorrhage). In the 2 most devastating cases, early leptomeningeal enhancement preceded by days the development of diffuse vasoconstriction.

Conclusion: This phenomenon may be of substantial clinical utility in early diagnosis and treatment in RCVS, as well as in elucidation of this syndrome's pathophysiology.

Disclosure: Nothing to disclose

EPR1042

Outcome of patients treated by mechanical thrombectomy for anterior circulation strokes during off-hours

O. Kaaouana¹, N. Bricout², B. Casolla³,
L. Della Schiava³, J.-P. Pruvo², C. Cordonnier³,
H. Hénon³, D. Leys⁴

¹Lille, France, ²Neuroradiology, University of Lille, Lille, France, ³Stroke Unit, Lille University Hospital, Lille, France, ⁴Department of Neurology - Stroke Unit, University of Lille, Lille, France

Background and aims: At off-hours, stroke patients have higher mortality and disability rates. The question of whether this off-hour effect exists in patients treated with mechanical thrombectomy (MT) remains unknown.

The aim of our study is to compare outcomes of patients treated by MT for cerebral ischaemia at off-hours vs. at working time.

Methods: We prospectively included consecutive adults who underwent MT alone or in combination with recombinant tissue – plasminogen activator (rt-PA) for a large-vessel occlusion in the anterior circulation between 2015 and 2019 in 12 stroke units. They underwent magnetic resonance imaging-scans at admission and 22-36 hours later. We evaluated outcomes at 3 months with the modified Rankin scale (mRS). To classify patients we used the time of groin puncture.

Results: We included 1,179 patients (631 women, 53.5%; mean age 72 years; median baseline NIHSS 17; 680 treated at off-hours, 57.7%; 734 treated with rt-PA, 62.3%; median delay between stroke recognition and end of MT 281 minutes). No patient was lost to follow-up. At 3 months, patients treated at off-hours did not differ for the proportion of patients with a mRS 0-1 (adjusted odds ratio [adjOR] 0.91; 95% confidence interval [CI] 0.68-1.22), or 0-2 (adjOR 0.92; 95%CI 0.68-1.23), and death (adjOR 1.24; 95%CI 0.89-1.73).

Conclusion: The slight tendency towards worse outcomes at off-hours was not significant. Therefore, off-hours effects can be minimized by a coordinated organisation of stroke care.

Disclosure: Unité Inserm U1171

EPR1043

Laboratory examinations – lessons learned from 120 cases treated with idarucizumab in Germany

P. Kermer¹, C. Eschenfelder², M. Grond³, H.-C. Diener⁴

¹Neurology, Nordwest-Krankenhaus Sanderbusch, Sande, Germany, ²Boehringer Ingelheim, Ingelheim, Germany, ³Neurology, Kreisklinikum Siegen, Siegen, Germany, ⁴Neurology, University Hospital, Essen, Germany

Background and aims: Recently we have shown that idarucizumab application in acute stroke patients treated with dabigatran improves clinical outcome parameters. In this retrospective series of 120 cases positive effects of dabigatran reversal could be documented regarding mortality and modified Rankin scale in patients with acute hemorrhagic stroke (aHS). At the same time, individuals with acute ischemic stroke (aIS), regained eligibility for intravenous thrombolysis, thereby improving substantially in NIH Stroke Scale (NIHSS).

Methods: We asked all German neurological/neurosurgical departments to contribute their retrospective data collected from administration of idarucizumab following product launch in January 2016 to June 2018.

Results: In aHS, 15 of 40 patients were on dabigatran 150mg bid, while 25 took 110mg bid. CrCl was above 50ml/min in all cases while thrombin time (TT) upon admission was elevated substantially in almost all cases examined. aPTT was normal in 79.5%. In aIS, 32 patients received 150mg, 48 received 110mg dabigatran bid. The vast majority of patients with ischemic stroke had a CrCl above 50ml/min. TT was prolonged above 35 seconds in 91.4% of cases while aPTT values were normal in 48.1% of patients.

Conclusion: These data underline the necessity to prescribe the appropriate dosage recommended in the prescription protocol to all patients. Furthermore, global hemostasis parameters like aPTT again prove to be not useful for therapeutic decisions. Finally, inclusion of TT values into emergency laboratory examination in patients with acute stroke under dabigatran is helpful to identify patients with impaired hemostasis potentially benefitting from idarucizumab application.

Disclosure: Nothing to disclose

Child neurology/developmental neurology; Clinical neurophysiology

EPR1044

Blink reflex habituation in patients with frontotemporal dementia: a preliminary study

S. Aristeidou, V. Constantinides, E. Kapaki, T. Zambelis, E. Anagnostou

Neurology, Eginition University Hospital, Athens, Greece

Background and aims: Blink reflex has a plethora of research applications including neurodegenerative disorders, migraine, psychiatric disorders and more. The aim of the present study is to test the value of the R2 habituation in patients diagnosed with frontotemporal dementia (FTD) in comparison to healthy individuals.

Methods: 10 healthy controls and 7 FTD patients participated in the study. Electrical stimulation was applied to the supraorbital (SO) nerve with stimulus intensities ranging from 15 to 25mA. Surface EMG responses were recorded from the orbicularis (Medtronic Keypoint 31A02). Paired stimuli at interstimulus intervals (ISIs) of 100, 200, 400 and 769ms were separated by 15 to 30s to minimize habituation. For each ISI we calculated the R2 amplitude ratio (expressed as R2 peak-to-peak amplitude of the conditioned response, divided by the R2 peak-to-peak amplitude of the unconditioned response). We evaluated the R2 habituation index by plotting the R2 amplitude ratio for all the tested ISIs.

Results: At ISI of 100ms the mean value of the R2 amplitude ratio was 0.740 for FTD patients and 0.276 for healthy controls, which was statistically different ($p=0.007$), and at ISI of 200ms the mean value of the R2 amplitude ratio was 0.737 for FTD patients and 0.327 for controls, which was also significantly different ($p=0.017$). No significant difference was found at ISIs of 400ms and 769ms.

Conclusion: FTD patients show a marked lack of habituation of the R2 response at high frequency paired stimulation. This might indicate a deficient cortico-bulbar control in this patient group.

Disclosure: Nothing to disclose

EPR1045

Influence of chronic radiofrequency electromagnetic fields exposure on sleep structure in preterm neonates: preliminary results

D. Besset, B. Selmaoui, S. Delanaud, R. De Seze, A. Léké, E. Stéphan-Blanchard
Péritox-INERIS Laboratory UMR_I 01, Jules Verne University of Picardy, Amiens, France

Background and aims: While hospitalized, preterm neonates are exposed to radiofrequencies (RF). Disruption of sleep mechanisms by RF exposure may disrupt their neurophysiological development. We investigated the influence of chronic RF exposure on sleep structure in preterm neonates.

Methods: Individual, continuous measurements of RF levels were performed on 25 preterm neonates (gestational age: 29 ± 2 wk, birth weight: $1,247\pm 367$ g) during the 1st 3 weeks after birth. An overnight polysomnography was performed on the last day of measurements. Individual RF exposure level over the whole recording period was expressed as the median (0.03 ± 0.01 V/m), the 99.9th percentile (P99.9, 0.1% of the highest values, 0.67 ± 0.29 V/m) and the highest value (maximum, 1.75 ± 0.66 V/m). Linear relationships were computed between RF exposure levels and sleep structure parameters: frequency, duration and percentage of sleep stages and wakefulness episodes.

Results: No significant relationship was found between the median level and sleep structure parameters. P99.9 was associated positively with rapid eye movement (REM) sleep frequency ($r^2=0.207$, $p=0.0223$) and negatively with both non-REM (NREM) proportion ($r^2=0.215$, $p=0.0195$) and the NREM longest episode ($r^2=0.168$, $p=0.0422$). The highest exposure value was also associated positively with REM sleep frequency ($r^2=0.165$, $p=0.0441$) but negatively with the average duration of REM episodes ($r^2=0.209$, $p=0.0217$) and the REM longest episode ($r^2=0.540$, $p=0.0054$).

Conclusion: These preliminary results suggest that sleep structure of preterm neonates is altered when exposed to chronic, low levels of RF during early life. Such alterations may depend on exposure levels. This finding raises the question of the repercussions of these sleep disturbances on the child's neurobehavioral and physiological outcomes.

Disclosure: Nothing to disclose

EPR1046

First symptoms in Niemann-Pick disease type C observed by family members: Clues for diagnosis?

A. Bicvic, R. Kalla, H. Kerkeni, J.P. Michelis, C. Bassetti, T. Bremova-Ertl
 Department of Neurology, Bern University Hospital, Berne, Switzerland

Background and aims: To comprehensively characterize the 1st symptoms noticed by family members in patients with Niemann-Pick type C (NPC).

Methods: 36 family members from 5 countries (Germany, UK, Greece, Slovakia, Czech Republic) responded to a paper or online questionnaire so far.

Results: Median age was 17 years (n=36, 49% F; interquartile range (IQR) 10-19), the age at the diagnosis was 6 years (IQR 1-16). Time from 1st symptom till diagnosis (MTTD) was 1 year (IQR 0-2.5), but varied largely. The infantile-onset MTTD was 1 year (IQR 0-1) and neonatal jaundice was the most frequent 1st symptom occurring in 67% of patients. This was also true for pediatric-onset MTTD (IQR 0-2.5) and impairment of gait was the most common 1st symptom (33%). In the juvenile-onset patients, MTTD was 0 years (IQR 0-16) and the most frequent symptom was impairment of gait (50%). In the adult group, MTTD was 2 years (IQR 0-21) and impairment of coordination was the most common symptom. Cataplexy was the most common 1st symptom observed by family versus physician (86% vs. 7%). Vertical supranuclear gaze palsy (VSGP) was present in 81% of patients, noticed in 54% by physician and in 42% by family. Hepato- or splenomegaly was most frequently 1st noticed by a physician than family (83% vs. 8%).

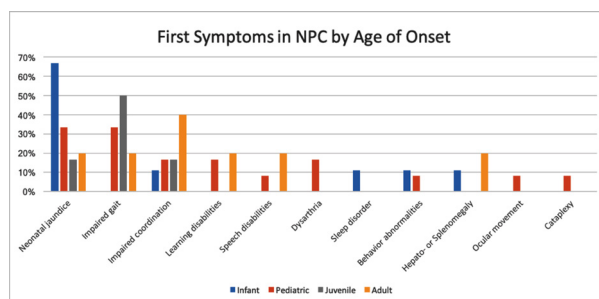

First Symptoms in NPC by Age of Onset

Conclusion: We present preliminary data of a multinational cohort on first symptoms observed by the family before the diagnosis of NPC was made. Hereafter, this essential knowledge may help to establish the diagnosis earlier and, thus, to faster allocate treatment.

Disclosure: Nothing to disclose

EPR1047

Single-fiber electromyography as an integral part of the diagnostic work-up of myasthenia gravis

D. Costa¹, A.P. Sousa², E. Santos¹, M. Cardoso²
¹Neurology Department, Centro Hospitalar Universitário do Porto, Porto, Portugal, ²Neurophysiology Department, Centro Hospitalar Universitário do Porto, Porto, Portugal

Background and aims: Stimulation single-fiber electromyography (sSF-EMG) is currently recognized as a more sensitive method than repetitive stimulation (RS) for the diagnosis of myasthenia gravis (MG), but presents a higher demand for technical expertise. We aimed to evaluate the diagnostic yield of the introduction of sSF-EMG in the everyday work-up of patients with suspected MG in a tertiary centre.

Methods: Patients submitted to sSF-EMG from 2016 to 2018 in our centre's Neurophysiology Department were retrospectively reviewed, and their clinical and electrophysiological data was collected.

Results: 93 patients met the inclusion criteria. 30 of those patients had the final diagnosis of MG by their attending neurologist, of whom: 11 presented with an altered RS and sSF-EMG (10 with clear criteria, 1 with borderline criteria), of which 9 were seropositive, with 3 ocular forms and 8 generalized forms; 5 presented with an altered sSF-EMG and normal RS (4 clear criteria and 1 borderline criteria), all of them seronegative, with 4 ocular forms and 1 generalized form; 14 patients presented with normal sSF-EMG and RS, of which 7 were seropositive, with 8 ocular forms and 6 generalized forms. 6 of these 7 seropositive patients were under immunosuppression at time of the exam. The 7 seronegative patients without neurophysiological alterations were diagnosed based on clinical presentation and response to treatment with pyridostigmine/immunosuppressant agents, and presented with less typical cases of MG. 2 patients with altered sSF-EMG presented diagnoses other than MG.

Conclusion: sSF-EMG demonstrated an increased diagnostic benefit compared with RS in patients with seronegative MG.

Disclosure: Nothing to disclose

EPR1048

Single EEG with standardised interpretation a specific predictor of poor outcome after cardiac arrest in everyday clinical setting

M. Kirbis¹, A. Jazbec², P. Žužek³, Š. Tadel Kocijančič²

¹Ljubljana, Slovenia, ²Intensive Internal Medicine, University Medical Centre Ljubljana, Ljubljana, Slovenia, ³Division of Neurology, University Medical Centre, Ljubljana, Slovenia

Background and aims: A single routine EEG with standardised interpretation has been shown, in a clinical trial, to predict poor outcome after cardiac arrest with 100% specificity. We aimed to replicate this finding in a routine clinical setting and compare the predictive value of EEG to somatosensory evoked potentials (SSEP).

Methods: Consecutive patients after primary cardiac arrest who had not regained consciousness after therapeutic hypothermia were included in the study. A standard 20-minute EEG was performed during working hours, described according to ACNS guidelines and categorised as highly malignant, malignant or benign as proposed by Westhall et al. Retrospectively EEG categorisation was revised by dedicated EEG specialists. Other investigations were performed at the attending physician's request. Poor outcome was defined as best Cerebral Performance Category 3-5.

Results: Included in the analysis were 76 patients, 63 had a poor outcome. EEG was recorded on average 3.8 (2-7) days after cardiac arrest. SSEP were performed in 65 patients. All patients with either absent SSEP or very malignant EEG had a poor outcome (100% specificity and 100% positive predictive value) with either original or specialist-revised EEG interpretation. Sensitivity for predicting poor outcome of very malignant EEG was 38%, of absent SSEP 31% and for the combination of both 47%.

Conclusion: Using standardised interpretation, EEG has 100% specificity in predicting poor outcome after cardiac arrest, same as SSEP. Combining both methods improves the proportion of patients correctly recognised as having poor prognosis. The described use of EEG is feasible in everyday clinical care.

Disclosure: Nothing to disclose

EPR1049

Use of sw LORETA qEEG to study the role of default mode network (DMN) in empathy processing

D. Kolev, D. Tsakova

Sofia, Bulgaria

Introduction: The number of studies using swLORETA qEEG technologies in neurobehavioral science has increased in recent years. The interest for these methodologies relies in their high-temporal resolution and greatly improved spatial resolution.

The brain's default mode network (DMN) include the posterior cingulate cortex (PCC) and medial prefrontal cortex (MPFC). DMN is the most extensive of the 3 major neural networks in the human brain.

Empathy is the ability to identify with another person's feelings or thoughts based on memory and self-referential mental simulation. The DMN in particular is related to self-referential empathy.

Objective: Using swLORETA qEEG to study whether individual differences in the core components of empathy are related to DMN effective connectivity (EC).

Methods: In order to study the possible neural mechanisms underlying empathy, we investigated the EC of the DMN in subjects from a general population. swLORETA qEEG imaging data were acquired from 19 subjects during a resting state and while watching an image with empathetic content. An independent component analysis was used to identify the DMN. Differences in EC strength were compared between the participants.

Results: The results obtained allow us to distinguish 2 groups. The low-empathy group showed lower EC of the MPFC (Brodmann areas 10, 11) and PCC (Brodmann areas 29, 31) within the DMN, compared to the high-empathy group. The results of the study suggest that empathy is related to EC of the MPFC/PCC within the DMN.

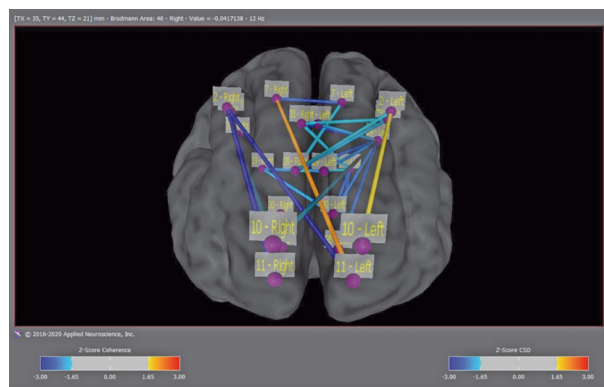

Fig.1 Effective connectivity in the DMN in a participant from the low-empathy group

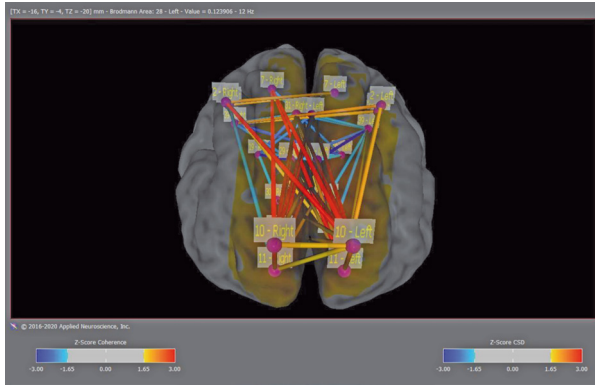

Fig.2 Effective connectivity in the DMN in a participant from the high-empathy group

Conclusion: Functional decreases in EC among low-empathy subjects may reflect an impairment of self-referential mental simulation.

Disclosure: Nothing to disclose

EPR1050

The improvement in diagnosis and epilepsy managing in children with progressive myoclonus epilepsy during the last decade – a single tertiary center experience

R. Kravljanac¹, M. Djordjevic², B. Vucetic Tadic³
¹Neurology, ¹University of Belgrade, Faculty of Medicine, Institute for Mother and Child Health Care of Serbia, Belgrade, Serbia, Belgrade, Serbia, ²Metabolic and Genetic disease, Institute for Mother and Child Healthcare of Serbia, Faculty of Medicine, University of Belgrade, Belgrade, Serbia, ³Neurology, Institute for Mother and Child Healthcare of Serbia, Faculty of Medicine, University of Belgrade, Belgrade, Serbia

Background and aims: The aim is to explore if diagnosis and epilepsy managing in children with progressive myoclonus epilepsy (PME) have been improved during last ten years.

Methods: The retrospective study included children with PME treated during 25-year period, divided in 2 groups: treated before December 2010 (I), and after, up to December 2019 (II). Only patients aged 0.2-18 years, with proven PME diagnosis by enzyme, genetic and/or histopathology investigations were included. Evaluated parameters were: etiology, seizure onset, the period from disease onset to diagnosis, and, as a measure of epilepsy control -SE frequency and recurrence rate. Statistical analysis included tests: Chi-Square, Mann-Whitney and ANOVA, using SPSS version 25.

Results: The study included 51 patients with PME, 27 in I and 24 in II group. The underlying diseases were: NCL (30), Gaucher (5), Niemann-Pick (4), mitochondrial (4), Lafora (3), Krabbe (2), KCNC1 gene mutation (2). Average duration from initial symptoms to diagnosis was 3.2 ± 3 years (I) vs. 1.4 ± 0.9 years (II). In 35 patients (68.6%) seizure was among initial symptoms. Both SE frequency 55.5% (15/27) vs. 37.5% (9/24), and recurrence rate (66.7% vs. 22.2%) were higher in the 1st group showing tendency towards, but not statistically significant difference.

Conclusion: The diagnosis and epilepsy managing in children with PME improved during the last decade. Earlier genetic diagnosis, its impact on appropriate antiseizure medications, together with better education of parents/caregivers as well as availability of effective prehospital rescue medications contributed to significantly decreased frequency and recurrence rate of SE.

Disclosure: Nothing to disclose

EPR1051

Hyperconnectivity and network rearrangement as a predictive biomarker of neurodegenerative dementia: results from a multicenter EEG study on Frontotemporal Dementia and Alzheimer's disease.

M. Russo¹, R. Franciotti², D. Moretti Vito³, A. Benussi⁴, C. Carrarini¹, D. Arnaldi⁵, G. Koch⁶, A. Cagnin⁷, F. Nobili⁸, B. Borroni⁹, M. Onofri¹⁰, A. Padovani¹¹, L. Bonanni¹²

¹Department of Neuroscience, Imaging and Clinical Sciences, University G. d'Annunzio of Chieti-Pescara, Chieti, Italy, ²University G. d'Annunzio of Chieti-Pescara, Chieti, Italy, ³Brescia, Italy, ⁴BRESCIA, Italy, ⁵Department of Neuroscience, Rehabilitation, Ophthalmology, Genetics, Maternal and Child Health (DINOEMI), University of Genova, Genoa, Italy, ⁶Rome, Italy, ⁷Neurology, University of Padua, Padua, Italy, ⁸Department of Neurological Sciences, Ophthalmology & Genetics, Università degli Studi di Genova, Genoa, Italy, ⁹Department of Clinical and Experimental Sciences, University of Brescia, Brescia, Italy, ¹⁰University Chieti Pescara, Chieti, Italy, ¹¹Department of Neurology, University of Brescia, Brescia, Italy, ¹²Chieti, Italy

Background and aims: EEG studies of functional connectivity have provided new measures of brain organization in neurodegenerative diseases, especially Alzheimer's disease (AD). We aim to study the macroscale modifications occurring in another neurodegenerative condition, Frontotemporal dementia (FTD), in comparison with AD.

Methods: Mutual information (MI) (measure of functional connectivity) and MI-based graph theory analysis (topological network descriptors) were measured on resting state EEG signals recorded in the prodromal stage of dementia, at onset of dementia and at 3 years follow-up in 18 FTD and 18 AD in comparison with 20 healthy controls.

Results: MI showed hyperconnectivity in FTD and AD vs. controls at the prodromal stage of dementia. Main hubs, present in controls, were lost in both disease groups, and substituted by provincial hubs in frontal leads in FTD and in parieto-occipital leads in AD. FTD and AD networks appeared to be rearranged in new small worlds.

Conclusion: Hyperconnectivity, increased small world propensity and local efficiency in salient areas of the neurodegenerative process of FTD and AD could be used as an early diagnostic biomarker of neurodegenerative dementia.

Disclosure: Nothing to disclose

EPR1052

Cognitive task-related functional connectivity alterations in temporal lobe epilepsy

O. Strýček¹, M. Lamoš², P. Klimeš³, I. Rektor¹

¹First Department of Neurology, St. Anne's University Hospital and Faculty of Medicine, Masaryk University, Brno, Czech Republic, ²Central European Institute of Technology (CEITEC), Masaryk University, Brain and Mind Research Program, Brno, Czech Republic, ³Institute of Scientific Instruments of the CAS, Brno, Czech Republic

Background and aims: We investigated cognitive task-related functional connectivity (FC) in patients with temporal lobe epilepsy (TLE). Using visual 3 stimulus paradigm we studied cognitive large-scale networks and impact of TLE on connectivity outside the temporal lobe.

Methods: High density EEG of 19 TLE patients with hippocampal sclerosis and 10 healthy controls (HC) were recorded during performing paradigm. Scalp data were reconstructed into the source space and FC was measured using phase lag index. Correlating with the neuropsychological data, possible compensatory mechanisms were investigated.

Results: Significant changes were found in FC of regions outside the epileptogenic network, most significantly between structures involved in the visual stimulus processing. These changes were more widespread in left temporal lobe epilepsy (LTLE). There were no significant differences in task performance in comparison with HC; implying that there must be compensatory mechanism. When correlated with neuropsychological data we found that mainly the right hemisphere was responsible for compensating for network alterations.

Conclusion: Our findings confirm the hypothesis that LTLE is the more pervasive form of disease. Even though the network alterations in LTLE are more severe, compensatory mechanisms reduce the impact of epilepsy on cognitive functions. Our suggestion of the compensatory role of the non-dominant hemisphere in TLE is novel.

Disclosure: Nothing to disclose

EPR1053

The changes of theta event-related synchronization/desynchronization in patients with post-operative cognitive dysfunction after on-pump coronary artery bypass grafting

I. Tarasova, O. Trubnikova, D. Kupriyanova, O. Barbarash

State Research Institute for Complex Issues of Cardiovascular Diseases, Kemerovo, Russian Federation

Background and aims: The risk of neurological complications after cardiac surgery remains currently significant. The aim of the study was to investigate the theta event-related synchronization/desynchronization (ERS/ERD) changes during visual selection task in patients after on-pump coronary artery bypass grafting (CABG) with and without postoperative cognitive dysfunction (POCD).

Methods: The study included 32 patients who underwent on-pump CABG, mean age 57.2 ± 6.08 years. All patients underwent extended neuropsychological testing and computer electroencephalography 3-5 days before and at 7-10 days after CABG. The POCD was determined according to the criterion: 20% decrease of cognitive indicator compared to one at baseline on 20% of the neuropsychological battery tests. Statistical processing was performed using the STATISTICA 10.0.

Results: The frequency of POCD was 69 % (22 patients). At the 7-10 days after CABG, the POCD patients had less pronounced theta ERD in the left fronto-central regions during the stage of 200-400ms in comparison to patients without cognitive decline. Only the patients without POCD had a decrease of event-related theta activity in the left parietal leads compared with baseline. During the stage of 600-800ms, the POCD patients also had less theta ERD in both fronto-central and parietal regions of right hemisphere compared to patients without POCD.

Conclusion: The patients with POCD after CABG had the pathological changes in the event-related theta activity. An analysis of event-related synchronization/desynchronization can be used as objective marker of POCD.

Disclosure: The reported study was funded by RFBR and Kemerovo region, project number 20-415-420005.

EPR1054

Internet addiction in Central Siberia urban adolescents: the prevalence and comorbidity with recurrent headache

S. Tereshchenko, L. Evert, N. Semenova, O. Zaytseva, M. Shubina

Department of child's physical and mental health, Scientific Research Institute of Medical Problems of the North, Krasnoyarsk, Russian Federation

Background and aims: Numerous studies have convincingly demonstrated Internet addiction (IA) comorbidity with a broad range of psychopathologic conditions such as depression and anxiety. Psychosomatic symptoms prevalence and types in Internet-addicted adolescents is not studied well. We aimed to investigate IA prevalence and its comorbidity with recurrent headache in Central Siberia urban adolescents.

Methods: 2950 urban Siberian (Krasnoyarsk) school-based adolescents (aged 12-18; boys/girl ratio 1348/1602) were tested with Chen Internet Addiction Scale (CIAS). Based on the CIAS, score Internet users were categorized into three groups: adaptive Internet users (AIU-1) (scoring 27-42); maladaptive Internet users (MIU) (scoring 43-64); and pathological Internet users (PIU) (scoring ≥ 65). Adolescents were also asked about headache presence/frequency and according to answer were divided into 3 groups: (1) No headache group, (2) frequent episodic headache with episodes frequency 1-15 per month, and (3) chronic headache with episodes frequency >15 per month. Chi-square test was used.

Results: The prevalence of AIU, MIU, and PIU were 50.4%, 42.8%, and 6.8%, respectively. Significant positive associations were detected between CIAS scores and headache, especially for chronic headache group ($p_{1-2}=0.0047$, $p_{1-3}<0.0001$, $p_{2-3}=0.0008$, where 1-AIU, 2-MIU, 3-PIU; Fig. 1).

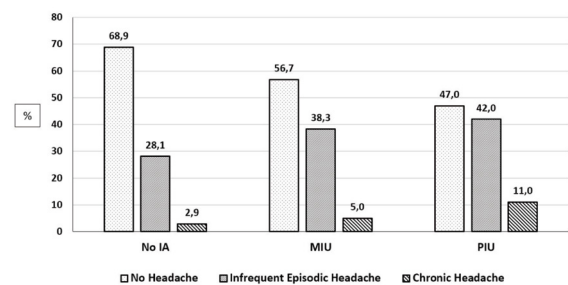

Fig. 1. Recurrent headache presence/frequency in Internet addicted adolescents.

Conclusion: The prevalence of Internet addiction (PIU) in Central Siberia urban adolescents is 6.8%. Internet addiction group have significantly higher headache frequency that may be explained by the presence of common risk factors such as emotional stress, depression, and anxiety.

The reported study was funded by RFBR according to the research project № 18-29-22032\18.

Disclosure: Nothing to disclose

Cognitive neurology/neuropsychology 1

EPR1055

Imaging correlates of action slowing in cortical neurodegenerative diseases

D. Andriuta¹, M. Roussel¹, J.-M. Constans², A. Aarabi³, O. Godefroy¹

¹Neurology, University Hospital of Amiens, Amiens, France, ²Department of Radiology, University Hospital of Amiens, Amiens, France, ³Laboratoire Neurosciences Fonctionnelles et Pathologies, Université Picardie Jules Verne, Amiens, France

Background and aims: Although action slowing has been recently identified as a leading deficit in early stages of degenerative cortical neurocognitive disorders (NCD), its mechanism and imaging correlates remains unknown. The objective was to determine imaging correlates using multivariate voxel based morphometry (VBM) of action slowing (focusing on simple reaction time (SRT)) in patients with cortical NCD.

Methods: We included 30 patients (16 mild NCD and 14 major NCD (Alzheimer's disease (n=9), Lewy body disease (n=3) and behavioral frontotemporal degeneration (n=2)) with a MMSE \geq 20, in Amiens academic memory center. Attentional and sensory-motor components of SRT (5th (C5) and 50th (C50) SRT percentiles z scores) were extracted using individual distribution analysis and age- and education adjusted using normative data. Following conventional VBM analysis ($p < 0.001$), significant clusters of voxels were submitted to multivariate linear general model according to a validated method.

Results: SRT were significantly slower in patients. SRT C5 was negatively associated with gray matter density of the right dorsolateroprefrontal cortex and the total intracranial volume (TIV) (model $R^2=0.287$, $p=0.004$). SRT C50 was negatively associated with the gray matter density of the left supramarginal region and the TIV (model $R^2=0.468$, $p < 0.001$).

Conclusion: Our results support action slowing at an early stage of cortical degenerative diseases and indicate that sensory-motor and attentional component depend on different structures: right DLPFC and left supramarginal. Right DLPFC role supports our earlier findings in fMRI activation study; the contribution of the left supramarginal, will be further explored using additional structural and functional connectivity analyses.

Disclosure: Nothing to disclose

EPR1056

Increased sensitivity to uncertainty guides decision-making in hippocampal dysfunction

B. Attaallah¹, P. Petitet², R. Zambellas¹, S. Irani¹, S. Manohar¹, M. Husain¹

¹Nuffield Dept Clinical Neurosciences, University of Oxford, Oxford, United Kingdom, ²Department of Experimental Psychology, University of Oxford, Oxford, United Kingdom

Background: The hippocampus plays an important role in many functions including memory and spatial cognition. However, its contribution to decision-making and valuation is under-investigated and yet to be established.

Objective: To determine the hippocampal contribution to information gathering behaviour and decision-making under uncertainty.

Methods: 17 patients with focal bilateral hippocampal atrophy (mostly as a result of autoantibody-associated limbic encephalitis) and 30 healthy matched controls underwent a novel behavioural task to investigate information gathering and decision-making under uncertainty, together with standard screening cognitive measures of memory and executive function.

Results: When actively gathering information to maximise rewards and reduce uncertainty, patients with hippocampal atrophy gathered significantly more information than controls prior to making a decision. This effect persisted when the need for memory was eliminated: when making decisions to accept or reject potential rewards in exchange for tolerating uncertainty, patients with hippocampal damage weighted uncertainty more, resulting in lower acceptance of the high-reward low-uncertainty offers. The results did not change after controlling for the differences in cognitive screening scores between patients and controls.

Conclusion: The results point to a potential role of the hippocampus in weighing up uncertainty against rewards. They indicate that the hippocampus and its functional networks might be involved in the psychopathology of behavioural syndromes that could result from deficits in processing of uncertainty and rewards, such as anxiety, an important feature of many brain disorders.

Disclosure: Nothing to disclose

EPR1057

Do deficits in Mitochondrial Spare Respiratory Capacity contribute to Neuropsychological changes seen in Alzheimer's disease (AD)?

S. Bell, M. De Marco, K. Barnes, D. Blackburn, P.J. Shaw, L. Ferriauolo, H. Mortiboys, A. Venneri
Sheffield Institute for Translational Neuroscience (SITraN),
University of Sheffield, Sheffield, United Kingdom

Background and aims: In clinical settings, AD is defined by characteristic deficits in neuropsychological testing supported by amyloid/tau biomarkers and neuroimaging abnormalities. The cause of neuropsychological changes is unknown. Tau deposition correlates with, but does not fully account for all neuropsychological impairments. Mitochondrial spare respiratory capacity (MRSC) is lowered in AD patient fibroblasts. This study investigates if fibroblast mitochondrial functional correlates with neuropsychological/neuroimaging changes in AD.

Methods: 10 AD patient and 10 control fibroblast were assessed. ATP and extracellular lactate were measured using luminescent and fluorescent protocols. Mitochondrial membrane potential (MMP) was measured using tetramethylrhodamine. Mitochondrial respiration and glycolytic function were measured using a Seahorse XF Analyzer. Neuropsychological testing and brain structural MRIs were undertaken on all participants. Correlations were performed between MMP, MRSC and neuropsychological/MRI AD markers.

Results: Reductions in delayed ($p<0.0001$), immediate recall ($p<0.0001$), semantic fluency ($p<0.0001$), phonemic fluency ($p=0.0033$) and MMSE ($p=0.0009$) scores were seen in AD patients. Controlling for age, education and brain reserve; left hippocampal ($p=0.001$), left parietal ($p=0.002$), right parietal ($p=0.001$) and anterior medial prefrontal cortical ($p=0.017$) gray matter volumes were reduced. AD fibroblasts had reduced MMP ($p=0.001$), MRSC ($p<0.0001$), glycolytic reserve ($p=0.05$), and extracellular lactate ($p<0.05$) levels. MRSC and MMP correlated significantly with immediate recall ([MRSC, $p=0.0041$], [MMP, $p=0.0115$]), delayed recall ([MRSC, $p=0.0013$], [MMP, $p=0.0138$]) and semantic memory ([MRSC, $p=0.0039$], [MMP, $p=0.009$]) tests. The correlations between MRSC and neuropsychological measures remained after controlling for age, education and brain reserve. No correlations were seen with grey matter volumes.

Conclusion: In-depth metabolic analysis of sporadic AD fibroblasts identifies functional abnormalities that correlate with neuropsychological features of AD.

Disclosure: This work has not received commercial support

EPR1058

TRIANA TEST: A preliminary evaluation of a new logical memory test

M. Bernal Sánchez-Arjona¹, S. Rodrigo-Herrero²,
A. Luque-Tirado³, A. Baquero⁴, J.L. Casado-Chocan²,
E. Franco-Macias¹

¹Seville, Spain, ²Neurology, Hospital Virgen del Rocío, Seville, Spain, ³Memory Disorders Unit, Department of Neurology, University Hospital Virgen del Rocío, Seville, Spain, ⁴Memory Disorders Unit, Department of Neurology, Hospital Virgen del Rocío, Seville, Spain

Background and aims: “Triana Test” (TT) is a new logical memory test based on the exciting love story between a flamenco dancer and a Japanese student. The aim was to study the diagnostic accuracy of TT to discriminate patients with Amnesic Mild Cognitive Impairment (aMCI) from normal controls (NC).

Methods: A phase I validation study. TT was administered to aMCI patients ($n=38$; memory complaints corroborated by a reliable informant, a total score on the Memory Associative Test of the district of Seine-Saint-Denis (TMA-93) $\leq 10^{\text{th}}$ percentile, and no functional impairment) and NC ($n=55$; no memory complaints, a total score on TMA-93 $\geq 25^{\text{th}}$ percentile, and no functional impairment). 4 variables were scored (maximum score for each=12 points): immediate free recall (IFR), immediate cued recall (ICR), deferred free recall (DFR), and deferred cued recall (DCR). The diagnostic accuracy of TT was estimated by the area under curve (AUC) using ROC curve analysis.

Results: For TT, scores on IFR (6.2 ± 2.2 vs 3.4 ± 2.4 , $p<0.001$), ICR ($9.8\pm 1.8\pm 7.7\pm 2.6$, $p<0.001$), DFR (6.8 ± 2.6 vs 2.7 ± 2.7 , $p<0.001$), and DCR (9.8 ± 1.9 vs $7.6\pm 7.6\pm 2.6$, $p<0.001$) were significantly lower in aMCI group vs NC group. The ROC curve analysis determined an AUC of 0.80 (95% CI, 0.70-0.89) for IFR, 0.74 (95% CI, 0.64-0.84) for ICR, 0.84 (95% CI, 0.76-0.92) for DFR, and 0.74 (95% CI, 0.64-0.84) for DCR, to discriminate aMCI patients from NC.

Conclusion: TT showed a good diagnostic accuracy to distinguish aMCI patients from NC.

Disclosure: Nothing to disclose

EPR1059

The Association of Personality Dimensions with Quality of Life in Parkinson's disease patients with motor fluctuations

M. Boussac¹, C. Arbus², J. Dupouy³, E. Harroch³, V. Rousseau³, F. Ory-Magne¹, O. Rascol⁴, C. Moreau⁵, D. Maltete⁶, T. Rouaud⁷, M. Meyer⁸, J.-F. Houvenaghel⁹, C. Marse¹⁰, C. Tranchant¹¹, E. Hainque¹², B. Jarraya¹³, S. Ansquer¹⁴, M. Bonnet¹⁵, L. Belamri¹⁶, M. Tir¹⁷, A.-R. Marques¹⁸, T. Danaïla¹⁹, A. Eusebio²⁰, D. Devos²¹, C. Brefel-Courbon³

¹TOULOUSE, France, ²Psychiatry department of the University Hospital of Toulouse, CHU Purpan, Toulouse, France, ³Department of Clinical Pharmacology and Neurosciences, Centre d'Investigation Clinique CIC1436, CHU Purpan, Toulouse, France, ⁴Department of Neurosciences and Clinical Pharmacology, Université de Toulouse, Toulouse, France, ⁵Lille, France, ⁶Neurology, Rouen university hospital, Rouen, France, ⁷Neurology, Hopital Laënnec, Nantes, France, ⁸Neurology Department, Nancy University Hospital, Nancy, France, ⁹Neurology, Rennes University Hospital, Rennes, France, ¹⁰Nice, France, ¹¹Neurologie, CHU Strasbourg, Strasbourg, France, ¹²Institut du Cerveau et de la Moëlle épinière, Département de Neurologie, Hôpital Pitié-Salpêtrière, AP-HP, Faculté de Médecine de Sorbonne Université, UMR S 1127, Inserm U 1127, and CNRS UMR 7225, Paris, France, ¹³Pôle Neurosciences, Foch Hospital, Paris, France, ¹⁴Service de Neurologie, Centre Expert Parkinson, CIC-INSERM 1402, CHU Poitiers, Poitiers, France, ¹⁵Centre expert Parkinson, Institut des maladies neuro-dégénératives, CHU Bordeaux, Bordeaux, France, ¹⁶Unité James Parkinson, Fondation Ophthalmologique A de Rothschild, Paris, France, ¹⁷Department of Neurology, University Hospital of Amiens, Amiens, France, ¹⁸Clermont-Ferrand, France, ¹⁹Centre Expert Parkinson, Hôpital Neurologique "Pierre Wertheimer, Hospices Civils de Lyon, Bron, France, ²⁰APHM, Marseilles, France, ²¹Department of Movement Disorders; INSERM U1171; Department of Movement Disorders, Lille Nord de France University, CHU Lille, Lille, France

Background and aims: As in most chronic disease, Quality of Life (QoL) is affected in Parkinson's disease (PD) patients. Moreover, it was shown that both physical and psychological health are impacting QoL, therefore personality dimensions are probably also associated with QoL in chronic neurological diseases such as PD. We have thus studied the association between different QoL scores and personality dimensions in fluctuating PD patients waiting for Deep Brain Stimulation of the Sub-Thalamic Nucleus (DBS-STN).

Methods: Data from all PD patients awaiting DBS-STN included in the French multicentric cohort study PREDI-STIM were used. The "Temperament and Character Inventory" (TCI) and the "Parkinson Disease Questionnaire 39" (PDQ-39) were filled before surgery. Adjusted univariate generalized linear regression models were used to study the association between PDQ-39 scores and TCI dimensions.

Results: In all fluctuating PD patient (n=363), there were a significative negative association between the Harm Avoidance temperament and QoL ($p=3e-11$, $R^2=0,18$), and a significative positive association between Self-Directedness and Cooperativeness characters and QoL (respectively, $p=2e-11$, $R^2=0,19$; $p=1e-3$, $R^2=0,1$). This association between personality and QoL was even more important with the mental component of QoL.

Conclusion: Low Harm Avoidance and high Self-Directedness and Cooperativeness scores are associated with a better QoL in fluctuating PD patients, mainly at an emotional and social level of QoL. Thus, focusing on the personal resources of these patients as therapeutic education seems to be important to improve their QoL.

Disclosure: The study was funded by the France Parkinson charity and French Ministry of Health (PHRC national 2012). This is an ancillary study to Protocol ID: 2013-A00193-42; ClinicalTrials.gov: NCT02360683.

EPR1060

Neuropsychological features at baseline and dementia conversion in a memory clinic sample

F. Carneiro, A. Silvestre, C. Guarda

Neurology, Hospital Garcia de Orta, Almada, Portugal

Background and aims: Cognitive assessment scales [Mini-Mental State Examination (MMSE), Addenbrooke Cognitive Examination (ACE)] are used to determine cognitive dysfunction and may be useful in predicting conversion to dementia in patients with memory complaints. We studied which items of the MMSE and ACE at baseline differed in patients presenting with memory complaints who later converted to dementia compared to non-converters.

Methods: Retrospective study of patients presenting to a memory clinic with primary memory complaints, without impaired activities of daily living (ADL), measured by the IADL questionnaire, with a follow-up >6 months. Objective cognitive impairment was defined as a score <1.5SD for age and ACE or MMSE (patients ≤1 year of education). Dementia was defined according to DSM-5 Criteria.

Results: Of 174 patients, 83 were included in the study. 42 (50.6%) patients converted to dementia (median time 20 months), with similar age, gender, education and global ACE and MMSE compared to non-converters at baseline. Converters showed significant worse scores at baseline on the recall item of the MMSE (median 2 vs 1; $p=0.006$) and free delayed recall (median 0 vs 1; $p=0.006$) of the ACE, which remained significant after logistic regression analysis controlling for age, sex and education.

Conclusion: In our sample, converters showed significant worse free delayed recall at baseline compared to non-converters, in line with previous studies of episodic verbal memory tests. Our results also highlight the need to consider performance in individual items of global assessment scales, apart from the global score, in predicting cognitive outcomes.

Disclosure: Nothing to disclose

EPR1061

ANTI-STIGMA training reduces stereotypes and increases GPs confidence in managing Neurocognitive disorders

L. Cartz Piver¹, A. Mailliet², B. Calvet³, N. Dumoitier⁴, M. Raychevae⁵, K. Rejdak⁶, A. Leperre Desplanques², P. Krolak Salmon²

¹Limoges University Hospital, Clinical and Research Memory Center, Limoges, France, ²Clinical and Research Memory Centre, Lyon Institute for Elderly, Lyon University Hospital, Lyons, France, ³Psychiatry, University Memory Clinic, Limoges, France, ⁴Limoges Medical University, Limoges, France, ⁵Clinic of Neurology, Medical University, Sofia, Bulgaria, Sofia, Bulgaria, ⁶Neurology, Medical University of Lublin, Lublin, Poland

Background and aims: Neurocognitive Disorders (NCD) affect approximately 9 million people in Europe. Negative stereotypes and lack of knowledge about benefits of timely diagnosis can result in delayed diagnosis and poor management. This pilot studied the impact of an “Antistigma” training to empower GPs to diagnose and act on NCDs.

Methods: In the context of the “Act On Dementia” European Joint Action, 4 medical universities (Limoges and Lyon in France, Sofia in Bulgaria, and Lublin in Poland) invited GPs and residents to an “Antistigma” training based on an ethical approaches and case studies. Pre- and post-questionnaires were performed to explore GPs’ and residents’ stereotypes about NCD and their self-confidence in NCD management, before and after the training.

Results: In 2018, 8 sessions of the “Antistigma” training were held in Limoges, France (3), in Lyon, France (1), in Bulgaria (2) and in Poland (2). Participants were 192 GPs and residents. There were no significant differences between the training centers, or between residents and GPs.

Before training, participants expressed high stereotypes about disclosure of NCD. After training, stereotypes were reduced significantly ($p<0.001$), and especially stereotypes about NCD disclosure ($p<0.001$). Participants’ confidence increased significantly in general and for each step of the pathway: initiating diagnosis, disclosure of NCD, managing care and anticipating needs ($p<0.001$).

Conclusion: During European Joint Action “Act On Dementia”, “Antistigma” training proved positive impact on GPs’ and residents’ attitudes and practices towards NCDs. Practices for NCD can be reinforced and harmonized in primary care across Europe.

Disclosure: Nothing to disclose

EPR1062

Combined social cognition measures improve the diagnostic accuracy of the behavioral variant of frontotemporal dementia

A. Dodich¹, C. Crespi², G. Santi³, S. Iannaccone⁴, A. Marcone⁴, M. Zamboni⁴, S.F. Cappa³, C. Cerami³
¹CeRiN Centre for Mind/Brain Sciences, University of Trento, Rovereto, Italy, ²Istituto Universitario di Studi Superiori, Pavia, Italy, ³Scuola Universitaria di Studi Superiori IUSS, Pavia, Italy, ⁴Clinical Neuroscience Department, San Raffaele Hospital, Milan, Italy

Background and aims: Severe socio-emotional impairments characterize the phenotype of the behavioral variant of frontotemporal dementia (bvFTD). Literature however reports social cognition disorders in other neurodegenerative syndromes. In this study, based on a clinical setting, we investigated accuracy of single social cognition task performance and combined social measures in the differential diagnosis of bvFTD.

Methods: We included 32 bvFTD, 26 Alzheimer's disease (AD), 16 primary progressive aphasia (PPA), 17 corticobasal syndrome (CBS) patients and 40 healthy control (HC) subjects. Ekman-60 faces Test (Ek-60F) and Story-based empathy task (SET) were administered to each subject. The emotion recognition and processing ERA index and the balance angle between SET sub-conditions were calculated. 1-way ANOVA was used to compare performances among groups, while receiver operating characteristic (ROC) curve tested ability to distinguish subjects with and without bvFTD.

Results: Compared to HC, all patient groups showed impaired performance at social tasks. ROC analysis showed good discriminative value for the ERA index + angle combination (bvFTD vs AD = AUC 0.73, cut-off 102.6, sens 0.62, spec 0.85; bvFTD vs PPA = AUC 0.75, cut-off 91.5, sens 0.56, spec 0.88; bvFTD vs CBS = AUC 0.80, cut-off 103.3, sens 0.63, spec 0.75; bvFTD vs HC = AUC 0.89, cut-off 143, sens 0.94, spec 0.70).

Conclusion: Accuracy analysis supported the advantages of a combined social measure over single task performance for the differential diagnosis of bvFTD. The use of a short battery in clinical settings may thus reduce uncertainties and improve the identification of the bvFTD phenotype.

Disclosure: Nothing to disclose

EPR1063

Evaluation of discriminative and early detection abilities of social cognition measures for the diagnosis of the behavioral variant of frontotemporal dementia: a systematic review

A. Dodich¹, C. Crespi², G. Santi², S.F. Cappa², C. Cerami²
¹CeRiN Centre for Mind/Brain Sciences, University of Trento, Rovereto, Italy, ²Scuola Universitaria di Studi Superiori IUSS, Pavia, Italy

Background and aims: Although loss of empathy is currently considered a core feature of the behavioral variant of frontotemporal dementia (bvFTD), the use of social tasks in the neuropsychological assessment of bvFTD is at present not required by any diagnostic guideline. In this systematic review, we explored the clinical maturity of social cognition measures in the early and differential diagnosis of bvFTD.

Methods: Papers were selected searching the PubMed and Medline databases. The search was limited to the available evidence regarding emotion recognition, empathy, theory of mind, and other social cognition skills. Only papers reporting indices of accuracy and/or sensitivity/specificity in classifying bvFTD from controls or other diseases were considered.

Results: Among the 160 papers initially included in the paper selection, only 14 papers were eligible for the scope of the present review. The accuracy of social cognition tasks for the early bvFTD detection in comparison with normal controls, as well as for the discrimination with Alzheimer's disease and psychiatric patients have been addressed in a very restricted number of studies, mainly focused on emotion recognition and theory of mind. The use of different cognitive measures hampers study comparability.

Conclusion: Study results suggest that no recommendation concerning the use of a specific social task in bvFTD is currently available. Although the literature seems to suggest that emotion recognition and ToM tasks could be the best choice to ensure a high diagnostic accuracy in clinical settings, there is the need of further specific investigations, including comparison studies.

Disclosure: Nothing to disclose

EPR1064

A retrospective assessment of the prognostic value of initial neuropsychological assessment in the syndrome of transient epileptic amnesia

M. Lefranc¹, V. Voltzenlogel¹, L. Di Bitonto², B. Cretin³
¹CERPPS, EA 7411, Université Toulouse II – Jean Jaurès, Toulouse, Toulouse, France, ²Centre Mémoire, de Ressources et de Recherche d'Alsace (Strasbourg-Colmar), France, Strasbourg, France, ³STRASBOURG CEDEX, France

Background and aims: The syndrome of transient epileptic amnesia (STEA) is related to mesial temporal lobe alterations and occurs commonly in the elderly. Consequently, there are STEA cases that inaugurate a neurodegenerative disease. These patients may possibly be identified early by the use of neuropsychological tests. Our work explored such hypothesis.

Methods: 97 STEA patients with sufficient follow-up (≥ 6 years) were included in this retrospective monocentric study. 33 were thereafter excluded because of missing data. In the 64 remaining patients, 2 groups were identified according to their cognitive status over time: 6 were “decliners” (progressive decrease of the MMSE score during follow-up) and 58 were “non-decliners” (stable or slightly fluctuating MMSE score). The 2 groups were compared for initial neuropsychological performances.

Results: The “decliners” were diagnosed with Alzheimer’s disease (AD) during follow-up. Our main result shows that “decliners” and “non-decliners” significantly differed on initial 16-items Free and Cued Selective Reminding Test (FCSRT) performances. All FCSRT trials (immediate recall, free and cued recalls, delayed free and cued recalls) were significantly decreased ($p < 0.01$) in “decliners” compared to “non-decliners”. Not all decliners had initial performances $< 2SD$, but using a composite score, they were identified with Sensitivity=87.9% and Specificity=100%.

Conclusion: An underlying AD is the possible etiology for few STEA patients (9.4% of our cohort). These patients can be detected early based on initial cognitive examination when using the FCSRT.

Disclosure: Nothing to disclose

Critical care; Education in neurology; Ethics in neurology

EPR1065

Digital Brain - digital collection of the Institute Psychiatry and Neurology

T. Stepień¹, A. Acewicz¹, S. Tarka², P. Felczak¹,
D. Chutoranski¹, M. Golan¹, N. Chmura¹,
A. Mietelska-Porowska³, T. Wierzba-Bobrowicz¹

¹Department of Neuropathology, Institute of Psychiatry and Neurology, Warsaw, Poland, ²Department of Forensic Medicine, Medical University of Warsaw, Warsaw, Poland, ³Neurobiology Centre, Nencki Institute of Experimental Biology, Warsaw, Poland

Background and aims: Human brain tissue derived from patients with neurological diseases remains the most appropriate material for research of the human brain under pathological conditions. Institute of Psychiatry and Neurology in Warsaw has an extensive and only in Poland collection of human brains obtained postmortem from patients with neurological diseases. Creating a digital, open-wide and easy-access database of collected brain tissue would allow quick and precise search of cases for the scientific or educational purposes.

Methods: We digitalize 5273 fixed whole and fragmented brains, 24372 paraffin blocks, 34558 histological sections, neuropathological protocols and medical data collected since 1952 in Institute of Psychiatry and Neurology. For project purposes, an internet platform was created to search, view and share digitized cases.

Results: Currently, most of the material has been verified, described and placed in correct locations in Institute of Psychiatry and Neurology. About 1000 cases were completely introduced into the created database. Website is under construction and will operate at www.digitalbrain.ipin.edu.pl. Project completion is estimated for 2022.

Conclusion: The digital, wide-open, easy-access database of the Institute of Psychiatry and Neurology human brains collection provides several, unique opportunities. It will allow quick search and evaluate of cases for the scientific, clinical, diagnostic and educational purposes both by obtaining desired material and by working directly on internet platform. We hope that it will establish extensive scientific cooperation, promote science and public awareness of nervous system diseases.

Disclosure: Project is supported by the „Digital Brain - digital collection of the Institute Psychiatry and Neurology” (Project No.POPC.02.03.01-00.0042/18).

EPR1066

Predicting the Quality of Clinical Performance in Neurology Residents

T. Milligan¹, F. Drislane²

¹Neurology, Brigham and Women's Hospital, Boston, USA, ²Boston, USA

Background and aims: It is very difficult to predict how well a student, still in university, will develop as a competent or even superior clinical neurologist during Neurology residency.

Methods: We collected data available at the time of application for Neurology residency positions and sought a correlation with clinical excellence as assessed by the Neurology residency program director. Data included: age at entry; US Medical Licensing Examination (“step”) scores; evaluations or grades in university Internal Medicine and Neurology rotations; overall clinical performance in university; perceived reputation of the university at which Medicine was studied; whether or not the applicant had additional years of clinical training (e.g. in Internal Medicine); time spent on research, and publications; and at what position the candidate was listed on the electronic ‘match’ list for resident selection.

Results: Data were collected covering 194 Neurology residents who began residency from 2008 until 2016 and completed residency training by June 2019 in 2 relatively large Neurology programs affiliated with the same university. Outcome was assessed at the conclusion of training 4 years later by the Neurology residency program directors who had worked with them throughout the residency -- by rank ordering residents within each class (year of training) in terms of relative clinical excellence.

Conclusion: Correlations between data available before the start of residency and the quality of clinical performance of Neurology residents by the end of training will be displayed, and a predictive model will be developed. Terminology and discussion will be adapted for suitability to European and other medical education systems.

Disclosure: Nothing to disclose

EPR1067

Dynamic cerebral autoregulation and neurovascular coupling impairments occur late in sepsis

L. Ferlini¹, F. Su², J. Creteur², F. Taccone², N. Gaspard¹
¹Neurology, ULB - Hopital Erasme, Brussels, Belgium,
²Intensive Care Unit, ULB, Bruxelles, Belgium, Brussels, Belgium

Background and aims: Prior studies suggest that sepsis alters the regulation of cerebral-blood-flow (CBF) (i.e. dynamic cerebral autoregulation (dCA) and neurovascular coupling (NVC)), which could lead to septic encephalopathy in up to 75% of cases. The temporal evolution of dCA and NVC impairment during sepsis progress is still unknown because relevant animal models are lacking. We studied dCA and NVC in a clinically relevant ovine model of septic shock.

Methods: Mechanically ventilated sheep were randomized to brief (<24h) faecal peritonitis (sepsis, N=13), prolonged (>24h) faecal peritonitis (late-sepsis, N=7) or sham procedure (N=15). dCA was evaluated by the Lx index and transfer-function-analysis; results were compared between the sham and the septic groups. The late-sepsis group served as its own control. The magnitude-squared-coherence (MSC) between electrical cortical activity and CBF was employed to estimate NVC. Repeated-measure ANOVA and Friedman test were used for statistical analysis.

Results: There were no differences neither in the Lx nor in the TFA parameters between the sepsis and the sham group, but dCA was statistically impaired in the late-sepsis-group (FIG.1). The MSC differed only in the late-group where a statistically significant reduction in the CBF power spectral density was noted (FIG.2); this confirms a disruption in the NVC due to a reduced efficiency of cerebral vessels to adjust CBF to cortical activity. dCA/NVC impairment was associated with cortical dysfunction (i.e. decrease in alpha-delta ratio (FIG.3)). No differences in MAP-PaCO₂-temperature were noted between groups.

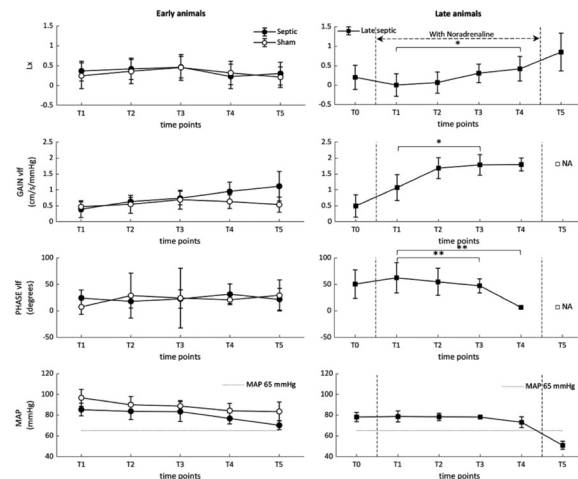

Early animals: sepsis and sham group. Late animals: late sepsis group (T0 corresponds to the last time point before noradrenaline infusion

which was started around 15h after sepsis induction when response to fluid challenge became suboptimal, in order to maintain MAP around 80mmHg). NA: data not significant because of a too low TFA coherence

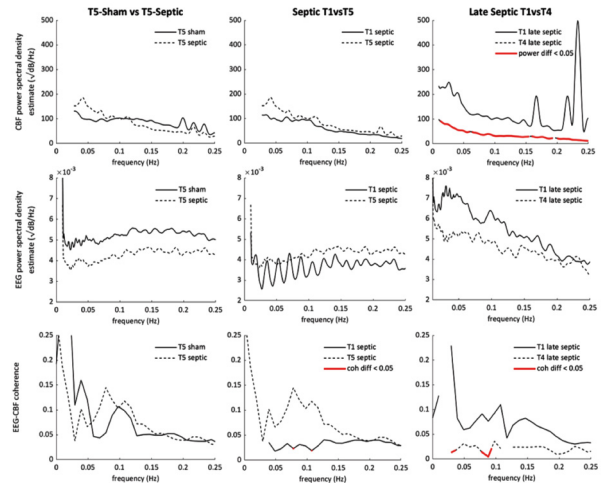

EEG-CBF coherence corresponds to the MSC. In red, the frequencies where a difference between time points were statistically significant (i.e. in the bottom right panel, a loss of MSC is evident for frequencies below 0.1Hz between the last time point before noradrenaline withdrawal (T4) and the T1)

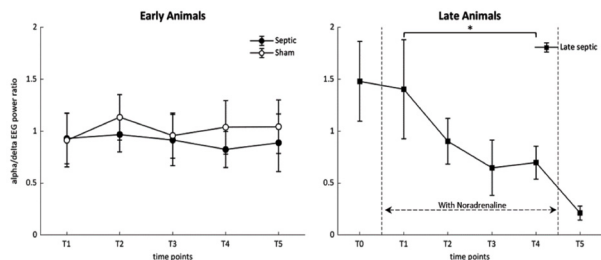

The alpha/delta power ratio of the EEG signal, a surrogate to quantify cortical function, was significantly decreased at T4 in the late-sepsis group, suggesting the presence of a brain dysfunction induced by NVC/dCA impairment.

Conclusion: dCA/NVC alteration develop late after sepsis induction and they are associated with brain dysfunction.

Disclosure: Nothing to disclose

EPR1068

Ethical decision-making in the management of pediatric patients with severe disorders of consciousness: A qualitative study

F. Merlo¹, M. Fadda¹, E. Albanese¹, C. Bassetti², R. Malacrida³

¹Public Health, University della Svizzera Italiana, Lugano, Switzerland, ²Department of Neurology, Bern University Hospital, Berne, Switzerland, ³Fondazione Sasso Corbaro, Bellinzona, Switzerland

Background and aims: The emergence of technologies that potentially extend the survival of patients with severe brain damages and uncertain prognoses poses clinical, legal and ethical challenges. This study aims to understand the criteria that guide physicians' decision-making in the management of pediatric patients with severe consciousness disorders such as unresponsive wakefulness syndrome and minimally conscious state.

Methods: Between January 2019 and January 2020, we conducted a qualitative study using a grounded theory approach and interviewed 18 Italian-speaking neurologists, intensivists and pediatricians based in Swiss hospitals.

Results: Not only participants use a variety of criteria to guide their decision-making (including etiology, quality of life, prognosis and invasiveness of the treatment) but they also interpret them differently and attribute different levels of importance to them. As a result, the interviewees differ in their strategies adopted during the decision-making process. A small number of the participants consult the scientific literature or discuss the approach with other peers outside their team, while the majority involve the team, follow the patient's family's wishes, or discuss the decision with colleagues from other specialties who are directly involved in the care of the patient. Moreover, for the majority of the interviewees, a pivotal role in managing a fruitful relationship with the patient's family is played by physicians' empathy, experience, communication skills, authoritativeness and emotional maturity.

Conclusion: The divergences in decision-making among physicians that we captured in this study suggest the need for novel, specific guidelines with regard to the management of pediatric patients with severe consciousness disorders.

Disclosure: Nothing to disclose

EPR1069

Breaking Bad News Training is Insufficient in Neurology Residencies in Brazil

T. Lima¹, F. Gushken², L. Degani-Costa³, N. Novaes⁴
¹Neurology, Hospital Israelita Albert Einstein, São Paulo, Brazil, ²Albert Einstein Medical School, São Paulo, Brazil, ³Internal Medicine, Hospital Israelita Albert Einstein, São Paulo, Brazil, ⁴Neurology, Universidade de São Paulo, São Paulo, Brazil

Background and aims: Developing good communication skills is essential in order to establish successful doctor-patient relationships. Communication skills becomes even more important when it comes to breaking bad news (BBN). In neurology, the ability to deliver bad news is especially important as many diseases have poor prognosis, resulting in chronic disability or death.

The aim of this project was to evaluate how BBN training is carried out in neurology residency programs in Brazil.

Methods: Preceptors and residents of neurology were asked to fill out surveys about how BBN skills were taught and practiced in residency programs.

Results: We collected 174 responses from 45 institutions in 17 states of Brazil. More than 90% of preceptors believe their programs require substantial improvement and more than 70% of residents are dissatisfied with current training. Only 16% of preceptors reported formal or simulation-based training, while 31% of the residents denied ever receiving specific training. In addition, 60% of the residents reported never having received feedback on how well they communicated bad news and 58.7% of preceptors admitted this was not standard practice in their programs.

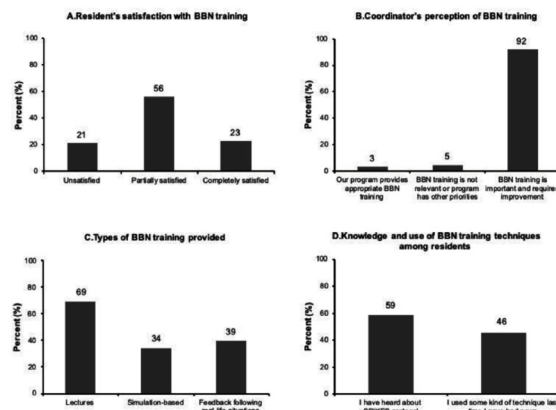

Overview of BBN training in Neurology residencies in Brazil. A) Resident's and newly certified neurologists (NCN)' satisfaction with BBN training provided during residency; B) Coordinators's perception of BBN training provided by their programs; C) Types of BBN training provided; D) Knowledge and use of BBN techniques among residents and NCN.

Conclusion: This study suggests that the current BBN training is deficient in neurology residency programs across Brazil. Given the relevance of such a skill to patients' care, every effort should be made to provide structured training opportunities during residency.

Disclosure: Thaiza Lima, MD. received a grant from the Ethics Committee of CREMESP (Conselho Regional de Medicina do Estado de São Paulo*) for performing this research. *São Paulo State Regional Medical Council

EPR1070

Time matters in brain health: how should society prepare for a growing population at risk of neurodegenerative diseases?

A. Noyce¹, G. Giovannoni², P. Scheltens³, D. Berg⁴, L. Brown⁵, K. Dierickx⁶, G.B. Frisoni⁷, J. Georges⁸, J. Hardy⁹, K. Heilbron¹⁰

¹Wolfson Institute of Preventive Medicine, Queen Mary University of London, London, United Kingdom, ²Blizard Institute and Wolfson Institute of Preventive Medicine, Queen Mary University of London, Barts and The London School of Medicine and Dentistry, London, United Kingdom, ³Alzheimer Center Amsterdam, Amsterdam University Medical Centers, Amsterdam, Netherlands, ⁴Department of Neurology, Christian-Albrechts University of Kiel, Kiel, Germany, ⁵Institute for Governance and Policy Analysis, University of Canberra, Canberra, Australia, ⁶Centre for Biomedical Ethics and Law, Catholic University of Leuven, Leuven, Belgium, ⁷Centre de la Mémoire, University Hospitals and University of Geneva, Geneva, Switzerland, ⁸Alzheimer Europe, Luxembourg City, Luxembourg, ⁹Department of Neurodegenerative Diseases, University College London, London, United Kingdom, ¹⁰2025andMe, Inc, Sunnyvale, USA

Background and aims: As people live for longer, the number of individuals who will develop neurodegenerative diseases is predicted to rise. Identifying those at greatest risk is the 1st step in prevention. Cultivating an attitude within society that accepts preventive approaches in neurology and encourages individuals to proactively prioritise their own brain health is vital.

Methods: A multidisciplinary, geographically representative group with expertise in dementia, Parkinson's disease, genetics, epidemiology, public health, patient advocacy and ethics developed an evidence-based set of recommendations to prepare a framework for a preventive approach to neurodegenerative diseases.¹

Results: The group produced 18 recommendations, targeting stakeholders involved in health promotion (5 recommendations), clinical practice (2) and research/decision-making (11). Recommendations covered the need for effective treatments, accurate diagnostic and progression markers, affordable tests to detect and diagnose disease and appropriate support for individuals seeking further information about 'brain health' and associated checks.

Conclusion: In the absence of suitable biomarkers and disease-modifying treatments, neurodegenerative diseases do not currently meet established screening criteria. Further work is needed to develop treatments for neurodegenerative diseases and validate diagnostic tools to identify people at risk. Meanwhile, healthcare decision-makers should start to pave the way for the advent of national programmes that facilitate risk assessment and earlier disease detection and

intervention, with appropriate consideration of the ethical implications. Stakeholders need to work together for these common goals.

1. Giovannoni G, Noyce AJ, Scheltens P et al. Time matters. A call to prioritize brain health. 2019. Available from: <http://www.oxfordhealthpolicyforum.org/reports/brain-diseases/brain-diseases-report>

Disclosure: Support for the development of this publication was provided by Oxford Health Policy Forum CIC, UK, funded by grants from Biogen and F. Hoffmann-La Roche, who had no influence on the content.

EPR1071

Resting-state NIRS-EEG in unresponsive patients with acute brain injury

M. Othman¹, M. Bhattacharya², K. Møller³, S. Kjeldsen⁴, J. Grand⁵, J. Kjærgaard⁵, A. Dutta², D. Kondziella¹

¹Copenhagen, Denmark, ²Department of Biomedical Engineering, University at Buffalo, The State University of New York (SUNY), Buffalo, USA, ³Neuroanesthesiology, Rigshospitalet, Copenhagen, Denmark, ⁴Dep, Rigshospitalet, Copenhagen, Denmark, ⁵Department of Cardiology, Rigshospitalet, Copenhagen, Denmark

Background and aims: Levels of consciousness in patients with acute brain injury are often difficult to assess. Near-infrared spectroscopy (NIRS) and electroencephalography (EEG) can be performed serially at the bedside at low costs, an important advantage in the ICU. However, combined NIRS-EEG has never been evaluated for acute brain injury and disorders of consciousness in the ICU.

Methods: We explored resting state oscillations in 8-channel NIRS oxyhemoglobin and 8-channel EEG band-power signals to classify levels of consciousness in patients with traumatic or nontraumatic brain injury in the ICU (n=9). Conscious neurological patients from step-down units and wards served as controls (n=14). We also explored NIRS-EEG to characterize changes in the levels of consciousness over multiple days in unresponsive ICU patients with repeated measurements (n=5).

Results: Neurovascular coupling between NIRS oxyhemoglobin (0.07-0.13Hz) and EEG band-power (1-12Hz) at frontal areas was sensitive and prognostic to changing consciousness levels. Unsupervised adaptive mixture independent component analysis (AMICA) revealed a mixture of 5 models, with the relative probabilities of these models reflecting levels of consciousness over multiple days. Weighted k-nearest neighbor classification of AMICA probabilities distinguished unresponsive patients from conscious controls with >90% accuracy (positive predictive value 93%, false discovery rate 7%) and, additionally, identified patients who subsequently failed to recover consciousness with >99% accuracy.

Conclusion: We suggest that NIRS-EEG for monitoring consciousness levels after acute brain injury is worthy of further exploration. Neurovascular coupling may be a marker of consciousness levels, and normalization of neurovascular coupling may herald recovery of consciousness after acute brain injury.

Disclosure: Nothing to disclose

EPR1072

Public perception and legislation of brain death, cardiac death and organ donation

M. Othman¹, A. Dutta², D. Kondziella¹

¹Copenhagen, Denmark, ²Department of Biomedical Engineering, University at Buffalo, The State University of New York (SUNY), Buffalo, USA

Background and aims: How the public perceives the difference between brain death and cardiac death and how this may influence attitudes towards organ donation, remains poorly understood. We investigated the public perception of brain death versus cardiac death and documented inconsistencies in the legislations of countries with different geographical, cultural and socioeconomic backgrounds.

Methods: Using a crowdsourcing approach, we randomized 1072 participants from 30 countries to either a case report of organ donation after brain death or to 1 following cardiac death. Further, we reviewed the scientific literature and sampled guidelines from 24 countries and 5 continents.

Results: Of all participants, 73.1% would be willing to donate all organs, while 16.0% would want to donate some of their organs. Exposure to “brain death” was not associated with a lesser likelihood of participants agreeing with organ donation (82.1%) compared to “cardiac death” (81.9%; RR 1.02, 95% CI 0.99 to 1.03; p=0.11). However, participants exposed to “cardiac death” were more certain that the patient was truly dead (87.9%±19.7%) than participants exposed to “brain death” (84.1%±22.7%; Cohen’s d 0.18; p=0.004). Sampling of guidelines and literature review revealed large differences between countries regarding procedures required to confirm brain death and cardiac death, respectively.

Conclusion: Implementation of organ donation after cardiac death is unlikely to negatively influence the willingness to donate organs, but legislation is still brain death-based in most countries. The time may be ripe to adjust legislations and increase the rate of cardiac death-based organ donation.

Disclosure: Nothing to disclose

EPR1073

Risk factors for hyperactive delirium after subarachnoid hemorrhage

V. Rass¹, T. Rinner¹, F. Reimann¹, A. Lindner¹, B.-A. Ianosi², M. Kofler¹, A.J. Schiefecker¹, R. Beer³, B. Pfausler⁴, R. Helbok³

¹Neurology, Neurological Intensive Care Unit, Medical University of Innsbruck, Innsbruck, Austria, ²Medical Informatics, UMIT - University for Health Sciences, Hall, Austria, ³Department of Neurology, Medizinische Universität Innsbruck, Universitätsklinik für Neurologie, Innsbruck, Austria, ⁴Neurointensive Care Unit, Medizinische Universität Innsbruck, Universitätsklinik für Neurologie, Innsbruck, Austria

Background and aims: Hyperactive delirium is common in patients with subarachnoid hemorrhage (SAH). In this study we aimed to identify risk factors for delirium and to evaluate its role on patients' outcomes.

Methods: In 276 SAH-patients admitted to a neurological ICU, daily RASS (Richmond Agitation Sedation Scale) and ICDSC (Intensive Care Delirium Screening Checklist) scores of the 1st 30 days were retrospectively collected by chart review. Hyperactive delirium was defined as ICDSC \geq 4 when RASS $>$ 0. Risk factors for delirium and its association with outcome (3-month mRS) were analysed using multivariable GLM. Patients without delirium reaching at least once a RASS \geq 0 served as reference group.

Results: Patients were 56 (IQR 47-67) years old and had an admission H&H grade of 3 (IQR 1-5). 65 (24%) patients developed hyperactive delirium at median 6 (IQR 3-16) days after SAH. 49 (18%) patients never reached a RASS \geq 0. In multivariable analysis, intubation $>$ 48hrs, aneurysm detection, lower H&H grade and pre-existing psychiatric disorder were associated with the development of delirium (Table 1). In matched analysis, the cumulative dose of midazolam before delirium onset was higher in patients with delirium compared to the control group (p=0.031). Overall, delirium was not associated with worse outcome (p=0.136). Interestingly, patients with delirium more often had a mRS of 1-3 (77%) compared to an mRS of 0 (14%) or 4-6 (9%).

Table 1: Risk factors for the development of hyperactive delirium			
Variable	Adjusted Odds Ratio	95% Confidence Interval	p-Value
Detection of an aneurysm (compared to non-aneurysmal SAH)	4.38	1.48-12.97	0.008
Intubation $>$ 48 hours	4.46	1.89-10.56	0.001
Pre-existing psychiatric disorder	3.17	1.14-8.83	0.027
Hunt and Hess grade (I-V)	0.63	0.48-0.83	0.001
Age, years	0.99	0.97-1.01	0.425

Table 1

Conclusion: Our data suggest that delirium has the highest incidence in patients with intermediate outcomes, suggesting that both, a certain severity degree and a minimum of neuronal connectivity is needed for the development of delirium.

Disclosure: Nothing to disclose

EPR1074

Low-resolution pressure reactivity index and its derived optimal cerebral perfusion pressure in adult traumatic brain injury: a CENTER-TBI study

L. Riemann¹, E. Beqiri², P. Smielewski³, M. Czosnyka³, N. Stocchetti⁴, O. Sakowitz⁵, K. Zweckberger¹, A. Unterberg¹, A. Younsi¹

¹Neurosurgery, Heidelberg University Hospital, Heidelberg, Germany, ²Physiology and Transplantation, Milan University, Milan, Italy, ³Brain Physics Lab, University of Cambridge, Cambridge, United Kingdom, ⁴Department of Anesthesiology and Intensive Care, Fondazione IRCCS, Cà Granda-Ospedale Maggiore Policlinico, Milan, Italy., Milan, Italy, ⁵Neurosurgery, Klinikum Ludwigsburg, Ludwigsburg, Germany

Background and aims: After traumatic brain injury (TBI), brain tissue can be further damaged when cerebral autoregulation is impaired. Regulating CPP according to computed optimal CPP (CPPopt) values based on cerebrovascular reactivity indices might contribute to prevent this. In this study, we examined the predictive value of a low-resolution long pressure reactivity index (L-PRx) and a multi-window, weighted CPPoptLPRx algorithm.

Methods: Using the multi-center CENTER-TBI study dataset, the association of L-PRx (correlation between 1min averages of intracranial pressure (ICP) and arterial blood pressure (ABP) over a moving time frame of 20min) and PRx (correlation between 10sec averages of ICP and ABP over a moving time frame of 5min) to outcome was assessed using univariate and multivariate regression analysis. CPPopt values were calculated using a multi-window algorithm that was either based on L-PRx or PRx and discriminative power was compared.

Results: L-PRx and PRx were both significant predictors of mortality in univariate and multivariate regression analysis. PRx displayed a higher discriminative ability, although the difference in area under the curves between L-PRx and PRx was not significant (DeLong's test). Similarly, deviations of actual CPP from calculated CPPoptLPRx and CPPoptPRx values were significantly associated with outcome in univariate and multivariate analysis with the CPPoptPRx trending towards more precise predictions.

Conclusion: Although LPRx and CPPoptLPRx did not reach the predictive power of the PRx and CPPoptPRx, they were still significantly associated with outcome. A prospective trial is needed to assess if CPP management according to CPPoptLPRx can improve clinical outcome.

Disclosure: LR received a scholarship from the CENTER-TBI study to visit the Brain Physics Lab in Cambridge.

EPR1075

Transcranial doppler ultrasound for brain death confirmation.

*A. Velayos Galán, P. Del Saz Saucedo, R. García Ruiz
Alcazar de San Juan, Spain*

Background and aims: Transcranial doppler (TCD) is a useful method of ancillary testing for determination of brain death (BD). The aim of this study is to describe TCD patterns found in patients with BD, assess the sensitivity and specificity results and contrast with literature.

Methods: We conducted an observational, prospective TCD examination of consecutive patients with clinical diagnosis of BD. We used the database register of the neurology ultrasonology laboratory. There were 49 BD studies of 13589 database registers between April 2009 and December 2018, 37 of them with clinical diagnosis of BD.

Results: We found male prevalence (71.4%), an age average of 51 years and the main cause of BD was brain hemorrhage. The temporal brain window was the most used and the middle cerebral artery was the most explored. 2 (5.4%) patients had inadequate transtemporal window. We registered increased pulsatility in 3 (8.1%), reverberating flow in 11 (29.7%), small systolic peaks in early systole in 14 (37.9%) and complete absence of flow with previously known adequate transtemporal window in 7 (18.9%). This study showed a sensitivity of 86% and a specificity of 100% of TCD for confirming BD.

Conclusion: Our results show high sensitivity and specificity of TCD for confirming BD, similar than previously reported and higher than other non-invasive methods. TCD is an useful, noninvasive and high-available method of ancillary testing for the determination of BD by an expert neurosonologist.

Disclosure: Nothing to disclose

Epilepsy 1

EPR1076

Cenobamate is a Novel Anti-Epileptic Drug with a Unique, Dual, Complementary Mechanisms of Action

E. Alvarez-Baron¹, R. Roeloffs², I. Lombardo³

¹Medical Affairs, Arvelle Therapeutics International GmbH, Zug, Switzerland, ²Research and Development, Arvelle Therapeutics, New York, USA, ³Research and Development, Arvelle Therapeutics International GmbH, Zug, Switzerland

Background and aims: Cenobamate is a novel anti-epileptic drug (AED) recently approved by the FDA. However, its mechanism of action has been only partially described. Here we present data supporting cenobamate's dual mechanism of action (MoA) increasing GABAA-receptor-mediated inhibitory currents and preferentially blocking persistent sodium excitatory currents.

Methods: Cenobamate was tested in models of radioligand binding displacement to assess its binding on GABAA receptors. Relative activities on human GABAA receptor subtypes were studied on 6 human GABAA ion channel subtypes expressed in heterologous cells. Potentiation of GABA-induced currents and effects on both phasic/tonic GABAA currents were assessed in rat hippocampal CA3 neurons, dentate gyrus granule cells (DGGC), and mouse/rat hippocampal CA1 neurons. Conventional whole-cell patch clamp assays obtained electrophysiological recordings.

Results: Cenobamate enhanced the current induced by 1 μ M GABA in a concentration-dependent manner, demonstrating positive modulation of GABAA receptors. Enhancement of GABAA receptor-mediated inhibitory currents occurred in both the phasic and tonic modalities in rodent hippocampal neurons. In addition to its modulation of several properties of voltage-gated Na⁺ channels, cenobamate acts as a preferential INaP inhibitor in neuronal voltage-gated Na⁺ channels to exert its anti-epileptic efficacy.

Conclusion: Most current AEDs either decrease neuronal excitation or increase neuronal inhibition. Cenobamate impacts both: it acts as a positive allosteric modulator of the GABAA receptor, binding to a site distinct from benzodiazepines and preferentially blocks persistent sodium currents enhancing the inactivated state of voltage-gated sodium channels. This complementary mechanism of action might be a key contributor to the high rates of responders shown during the placebo-controlled clinical trials.

Disclosure: Nothing to disclose

EPR1077

A comprehensive machine learning-based software pipeline to classify EEG signals: a case study on PNES vs control subjects.

M. Ascoli¹, G. Varone¹, S. Gasparini¹, E. Ferlazzo¹, V. Cianci², G. Mastroianni², G.G. Tripodi², F. Vazzana², C. Paleologo², R. Ieracitano², C. Zucco¹, B. Calabrese¹, M. Cannataro¹, U. Aguglia¹

¹Department of Medical and Surgical Sciences, Magna Graecia University Catanzaro, Catanzaro, Italy, ²Regional Epilepsy Centre, Great Metropolitan Hospital, Reggio Calabria, Italy

Background and aims: Diagnosis of psychogenic non-epileptic seizures (PNES) by electroencephalography (EEG) is a not trivial task during clinical practice for the neurologist. No clear PNES electrophysiological biomarker has been found yet, and only video-EEG monitoring with recording of typical episodes is the gold standard for diagnosis

Methods: In this study, we analysed 10 EEG time series recordings from 10 patients (2 males, age 28 \pm 12.4) with PNES and 10 healthy subjects (3 males; age 33 \pm 13.93). PNES diagnosis was made based on a typical episode recorded during video-EEG, with EEG showing neither concomitant ictal activity nor post-ictal changes.

A novel software pipeline that consists of a semi-automatic signal processing technique and a supervised Machine Learning (ML) classifier to aid discriminative diagnosis of PNES via EEG time series, is proposed. The software framework consists of (i) artifact rejection EEG module; (ii) feature extractor in frequency domain; (iii) classifiers based on different ML algorithms, such as Support Vector Machine (SVM), Linear Discriminant Analysis (LDA) and Bayesian Network. The classification scores were evaluated using Random Split and Leave One Out-Validation.

Results: The first experiments on a dataset including PNES and control subjects showed good accuracy (between 75% and 87%, depending on classifiers and validation methods). LDA with LOO-Validation had the best accuracy (87%).

Conclusion: The promising results of the proposed software pipeline suggest that it may be a valuable tool to support existing clinical diagnosis.

Disclosure: Nothing to disclose

EPR1078

Relation between caffeine consumption and risk of seizure-related respiratory dysfunction in patients with drug-resistant focal epilepsy

J. Bourgeois-Vionnet¹, P. Ryvlin², J. Jung³, R. Bouet⁴, M. Leclercq³, L. Bezin⁴, S. Rheims¹

¹Lyons, France, ²Lausanne, Switzerland, ³Hospices Civils De Lyon, Lyons, France, ⁴Inserm, Lyons, France

Background and aims: About 33% of focal seizures are associated with central apnea resulting in transient hypoxemia. Caffeine promotes spontaneous breathing by antagonizing adenosine. However, the relation between caffeine consumption and risk of seizure-related respiratory dysfunction in patients with drug-resistant focal epilepsy remains unknown

Methods: We reviewed the video-EEG recordings of 108 patients with drug-resistant focal epilepsy included in the SAVE study to identify those with ≥ 1 focal seizure, valid SpO₂ measurement and information about coffee consumption. This latter was collected at inclusion using a standardized self-questionnaire and further classified into four groups: none, rare (less than 3 cups/week), moderate (from 4 cups/week to 3 cups/day) and high (more than 4 cups/day). Ictal/post-ictal hypoxemia (IH) was defined as SpO₂<90% during at least 5 seconds. Association between hypoxemia and person- or seizure- specific variables was analyzed after correction for individual effects and the varying number of seizures.

Results: All data were available for 83 patients and 315 seizures. IH was observed in 64 seizures. Occurrence of IH was independently associated with temporal lobe epileptogenic zone ($p < 0.001$) and coffee consumption ($p = 0.003$). In comparison with high coffee consumption, odds ratio for no, rare and moderate coffee consumption was 9.34 (95% CI 2.6-34.0), 3.57 (95% CI 0.99-12.8) and 2.03 (95% CI 0.54-7.69). Duration of IH and SpO₂ nadir were not associated with coffee consumption.

Conclusion: The risk of IH dramatically varied as a function of coffee consumption, with preventive effect of high consumption. This result needs to be further investigated in interventional studies.

Disclosure: Nothing to disclose

EPR1079

Efficacy and Safety of Cenobamate in European Epilepsy Patients with Uncontrolled Focal-Onset Seizures

C. Brandt¹, J.C. Sanchez², B. Steinhoff³, J. Serratos⁴, I. Milanov⁵

¹General Epileptology, Bethel Epilepsy Centre, Bielefeld, Germany, ²Neurology Service, Hospital Clinico Universitario San Cecilio, Granada, Spain, ³Department for Adults, Kork Epilepsy Center, Kehl-Kork, Germany, ⁴Neurology, Fundación Jiménez Díaz, Madrid, Spain, ⁵Neurology Clinic, Medical University of Sofia, Sofia, Bulgaria

Background and aims: There is a need for more effective anti-epileptic drugs (AEDs) since approximately 40% of patients do not achieve seizure freedom despite treatment with 2 AEDs. Here, we present the results of cenobamate, a novel AED, in European epilepsy patients with uncontrolled focal onset seizures (FOS).

Methods: This was a post-hoc analysis of a double-blind, placebo-controlled trial. Adults with uncontrolled FOS treated with concomitant 1-3 AEDs were assigned to once-daily adjunctive cenobamate 100mg, 200mg, 400mg, or placebo. There was a 6-week titration and a 12-week maintenance phase. Primary European endpoint was responder rate ($\geq 50\%$ reduction in seizure frequency from baseline) in the maintenance phase; prespecified secondary included seizure freedom (maintenance phase). Safety and tolerability were assessed.

Results: In Europe, 250 patients were enrolled. Median disease duration ranged from 21-28 years. Responder rates during the maintenance phase were 42%/52%/63% for 100mg/200mg/400mg cenobamate vs 31% for placebo. Seizure freedom occurred in 4%/15%/25% in patients receiving 100mg/200mg/400mg vs 2% for placebo. Overall, the most common AEs ($\geq 10\%$) were somnolence, dizziness, headache, fatigue, and diplopia. Efficacy and safety were consistent with the overall study population.

Conclusion: Complete control of seizures is the ultimate goal of therapy, but the probability of achieving seizure-freedom diminishes with each failed treatment to less than 5% after the second AED. Adjunctive treatment with cenobamate showed significantly higher percentage of responders compared with placebo, including 100% responders. Cenobamate is a novel AED with the potential of improving outcomes for FOS patients with uncontrolled epilepsy. Results here were consistent with the overall patient population.

Table 1. Responder Rates, %	Cenobamate 100mg (N=57)	Cenobamate 200mg (N=60)	Cenobamate 400mg (N=60)	Placebo (N=58)
$\geq 50\%$ Reduction	42.1% <i>P</i> =0.2486	51.7% <i>P</i> =0.0262	63.3% <i>P</i> =0.0005	31.0%
$\geq 75\%$ Reduction	19.3% <i>P</i> =0.1133	35.0% <i>P</i> =0.0007	45.0% <i>P</i> <0.0001	8.6%
$\geq 90\%$ Reduction	7.0% <i>P</i> =0.4385	23.3% <i>P</i> =0.0022	31.7% <i>P</i> <0.0001	3.4%
100% Reduction	3.5% <i>P</i> =0.6184	15.0% <i>P</i> =0.0167	25.0% <i>P</i> =0.0002	1.7%

P-values vs placebo

Responder rates

Disclosure: Study 017 (NCT01866111) was sponsored by SK Life Science, Inc. and the analyses supported by Arvelle Therapeutics International GmbH

EPR1080

Distinctive electrographic patterns of clinical and subclinical focal seizures

M. Castillo Rodriguez, A. Schulze-Bonhage, A. Brandt
Epilepsy, Epilepsy Center, University Hospital Freiburg,
Freiburg, Germany

Background and aims: Ambulatory EEG devices are becoming a common tool in the neurological praxis for the follow up of patients with epilepsy. However, since many seizures are imperceptible or remain disregarded by the patient and considering the presence of EEG artifacts, the scrutiny of epileptic seizures could become a tough task in the interpretation of long-term EEG data. This study was designed to identify distinctive electrographic patterns of clinical and subclinical seizures for evaluation of long-term scalp EEG data.

Methods: Scalp EEGs of 50 patients (n=468, age 7-68y, 30 male) with focal epilepsy, structural and non-structural (40 epilepsy temporal lobe, 10 extratemporal patients) were retrospectively evaluated regarding the total duration of electrographic seizure patterns, the number of electrodes involved, extension to ipsilateral or contralateral electrodes, and the presence of ictal patterns. Results were analysed with Wilcoxon Rank-Sum and Fisher exact tests.

Results: Statistically significant differences between subclinical and clinical seizures were found for all studied aspects. Subclinical seizures showed a shorter duration, a low number of involved electrodes and less frequent propagation beyond the temporal lobe and to the contralateral cerebral hemisphere ($p=2.41 \cdot 10^{-8}$; $p=2.494 \cdot 10^{-7}$; $p=0.001113$ and $p=7.182 \cdot 10^{-13}$ respectively). Furthermore highly variable electrographic patterns of frequency and configuration were observed in either form of electrographic patterns within the same patient.

Conclusion: This study demonstrates the existence of several electroencephalographic features distinguishing clinical and subclinical seizures which may allow the scrutiny of interpretations of long-term EEG data. Moreover, it takes a step forward the understanding of epileptic dynamics across different brain regions.

Disclosure: Nothing to disclose

EPR1081

Incidence of epilepsy in Denmark 1977-2016

J. Christensen¹, C. Linehan², T. Tomson³, T. Marson⁴,
J. Dreier⁵, E. Esbace⁶

¹Viby, Denmark, ²School of Psychology, University College Dublin, Dublin, Ireland, ³Karolinska Institute, Stockholm, Sweden, ⁴Unit of Neuroscience Research, University of Liverpool, Liverpool, United Kingdom, ⁵Aarhus V, Denmark, ⁶Department of Neurology, Aarhus University Hospital, Aarhus, Denmark

Background and aims: Long-time trends of epilepsy incidence from large cohorts have not been previously studied.

Methods: Study population: We estimate the incidence of epilepsy among individuals born in Denmark, who were alive and living in Denmark at the start of follow-up (birth or 1. January 1977, whichever comes later) N=7,360,166. Identification of individuals with epilepsy: Using data from the Danish National Patient Registry, we identified all epilepsy diagnoses (ICD-8: 345, excl. 345.29 and ICD-10: G40).

Identification of individuals with psychiatric disorders: Using data from the Danish Central Psychiatric Register, we identified all psychiatric disorders diagnoses (ICD-8: 290-315 and ICD-10: F00-F99).

For each calendar year, age and sex, we calculated the incidence of epilepsy as the number of persons diagnosed for the 1st time with epilepsy divided by the total number of people alive and living in Denmark at that age and year.

Results: The incidence of epilepsy was higher in males than in females and particular high in persons with co-morbid psychiatric disorders (Table 1).

Table 1. Overall sex specific incidence of epilepsy in Denmark from 1995 to 2016.

	Person-years	Incident epilepsy patients (n)	Incidence rate, per 100,000 person-years
Overall	108,622,700	85,728	78.9 (95% CI: 78.4-79.5)
Males	53,891,950	45,719	84.8 (95% CI: 84.1-85.6)
Females	54,730,750	40,009	73.1 (95% CI: 72.4-73.8)
With psychiatric disorder			
Overall	7,014,431	15,080	215.0 (95% CI: 211.6-218.4)
Males	3,124,086	7,864	251.7 (95% CI: 246.2-257.3)
Females	3,890,345	7,216	185.5 (95% CI: 181.3-189.8)
Without psychiatric disorder			
Overall	101,608,270	70,648	69.5 (95% CI: 69.0-70.0)
Males	50,767,864	37,855	74.6 (95% CI: 73.8-75.3)
Females	50,840,406	32,793	64.5 (95% CI: 63.8-65.2)

Table 1.

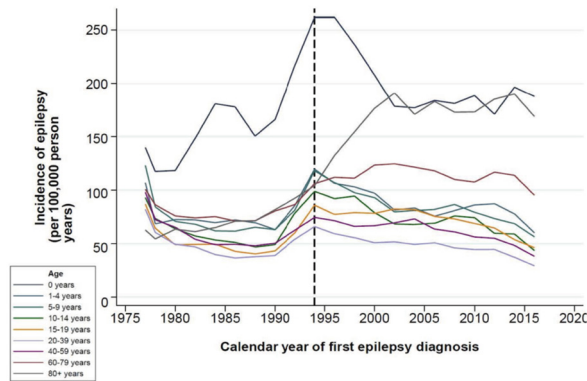

Figure 1

Conclusion: The incidence of epilepsy is highly age and sex specific and associated with psychiatric disorders. The incidence was remarkable stable in recent decades.

Disclosure: The study was supported by the European Union (www.esbace.eu)

EPR1082

Analysis of thalamic oscillatory activities may predict responsiveness to DBS of the anterior nuclei of the thalamus

B. Deuschová¹, D. Fabo², P. Klimeš³, P. Jurák³, P. Daniel¹, I. Rektor¹

¹Neurology, Saint Anne's University Hospital, Brno, Czech Republic, ²Budapest, Hungary, ³Institute of Scientific Instruments of the CAS, Brno, Czech Republic

Background and aims: Deep brain stimulation (DBS) of the anterior nuclei of the thalamus (ANT) is a promising therapeutic approach in patients with intractable epilepsy.

Methods: We analyzed intracerebral recordings from externalized DBS electrodes targeted bilaterally in the ANT in 14 patients with more than 1 year of follow up. Electrode contacts were located in the ANT and adjacent structures. 8 patients were responders with at least 50% seizure reduction; 6 were non-responders.

3 types of bipolar EEG were defined: recorded from 2 contacts in the ANT (IN), from 1 contact in the ANT and a 2nd 1 out of the ANT (BRIDGE), and from both contacts out of the ANT (OUT).

In the local field EEG, spectral power (PW) and power spectral entropy (PSE, describing system complexity) were analyzed. We calculated normalized spectral power and normalized power spectral entropy in the following passbands: 1-4Hz, 4-8Hz, 8-12Hz, 12-20Hz, 20-45Hz, 65-80Hz and HFO: 80-200Hz (ripple), 200-500Hz (fast ripple).

Results: PW analysis displayed significant differences between positive and negative outcomes in the delta, theta, high-gamma, ripple, and fast ripple frequency bands. PSE analysis displayed significant differences between positive and negative outcomes in all frequency bands. Differences were significant in the BRIDGE; there were no significant differences in the OUT and IN.

Conclusion: Significant differences in thalamic EEG oscillatory activities between responders and nonresponders with bilateral ANT DBS were detected. We suggest that analysis of EEG recorded from the ANT could predict response to ANT DBS.

Disclosure: Nothing to disclose

EPR1083

Slow titration of Cannabidiol add-on treatment in patients with drug resistant epilepsy provides a better safety profile

G. D'onofrio¹, M. Kuchenbuch², N. Chemaly², C. Hachon Le Camus³, S. Napuri⁴, D. Ville⁵, A. De Saint Martin⁶, T. Sokphon Teng⁷, N. Villeneuve⁸, R. Nabbout²

¹Department of Woman and Child's Health, University Hospital of Padua, Padua, Italy, ²UMR 1163, Centre de référence des épilepsies rares, service de neuropédiatrie, Insitut imagine, Necker Enfants malades, Paris, France, ³Unité de Neurologie Pédiatrique, Hôpital des Enfants, Toulouse, Toulouse, France, ⁴Department of Pediatrics, Rennes University Hospital, Rennes, France, ⁵Department of Pediatric Neurology, Femme Mère Enfant University Hospital, HCL, Bron, France, Lyons, France, ⁶Department of Pediatric Neurology, Strasbourg University Hospital, Strasbourg, France, ⁷Reference center for rare epilepsies, Necker Enfants Malades Hospital, APHP, Paris, France, ⁸Pediatric Neurology Department, Reference Center for Rare Epilepsies, Timone Children Hospital, APHM, Marseilles, France

Background and aims: To assess adverse events (AE) and efficacy of add-on Cannabidiol (CBD) with a slower titration compared to randomized controlled trials (RCTs).

Methods: We conducted a prospective, open-label, multi-center study involving 6 centers (French reference centre for rare epilepsies). All patients had a slow titration reaching target doses within at least 1 month. Follow-up included efficacy and AE evaluation at 1, 2 and 6 months.

Results: 125 patients were enrolled (62 Lennox-Gastaut, 48 Dravet, 5 Tuberous sclerosis, 10 other etiologies). Median concomitant anti-epileptic drugs (AEDs) was 3 (range 2-3), treatment duration 9 months (range 6-11) with a mean dose of 10mg/kg/day at M1 (M1), 15mg/kg/day at M2 and 17mg/kg/day at M6. 25 patients (20%) discontinued CBD, 21 due to lack of efficacy, 3 due to AE and 1 due to SUDEP.

AE were observed in 61 patients (48.8%). The most common were somnolence (19.2%), aggressivity (13.6%) and fatigue (12%). Somnolence and fatigue were significantly associated with the number of AEDs (P=0.012) but not with any specific AED.

Abnormal liver function tests >3X the upper limit were reported in 11.2% and significantly associated with valproate (P=0.04) or clobazam (P = 0.04).

Seizures frequency decreased without significance between baseline and M1, 2 and 6. Parents and practitioners' satisfaction about CBD were significantly higher at M6 compared to M1 and M2 (P = 0.001).

Conclusion: Results showed that a slower titration of CBD dose is better tolerated comparing our results to RCTs.

Disclosure: Nothing to disclose

EPR1084

In vivo interictal signatures of human periventricular nodular heterotopia

V. Frazzini¹, S. Whitmarsh², K. Lehongre², P. Yger³, B. Mathon⁴, C. Adam⁵, D. Hasboun⁶, V. Lambrecq⁵, V. Navarro⁵

¹AP-HP, Pitié Salpêtrière Hospital, Epilepsy Unit and Reference Center for Rare Epilepsies, Institut du Cerveau et de la Moelle épinière, ICM, INSERM, CNRS, Paris, France. Sorbonne Université, Paris France, ²Institut du Cerveau et de la Moelle épinière, ICM, INSERM, CNRS, Paris, France, ³Institut de la Vision, INSERM UMRS 968, UPMC UM 80, Paris, France, ⁴Institut du Cerveau et de la Moelle épinière, ICM, INSERM, CNRS, Paris, France. Sorbonne Université, Paris France. AP-HP, Pitié Salpêtrière Hospital, Department of Neurosurgery, Paris, France, ⁵Neurology, La Pitié-Salpêtrière Hospital, Paris, France, ⁶Sorbonne Université. AP-HP, Pitié Salpêtrière Hospital, Department de Neuroradiology, Paris, France

Background and aims: Periventricular nodular heterotopia (PNH) is a common cause of drug-resistant epilepsy, characterized by nodules of ectopic neurons adjacent to the lateral ventricles. In contrast to other types of cortical malformations, no unique interictal patterns have been described in PNH. The goal of our study was to identify interictal LFP signatures and the underlying neuronal substrates that originate within the epileptogenic nodules in PNH.

Methods: Interictal patterns were described on an unprecedented level of microscopic detail by means of microelectrode recordings from three PNH nodules in 2 patients. LFP patterns were identified on the basis of their morphological and pathological features and then described in the time and frequency domains. Single units were extracted using spike-sorting algorithms, after which extracellular spike-width and peak-trough time were used to describe units on the basis of detected morphological and electrophysiological features

Results: Highly consistent interictal activities were identified in all 3 nodules 1) trains of periodic slow waves (n=2855), 2) isolated slow deflections (n=1631), both with superimposed fast activity, and 3) epileptic spikes (n=6986). Patterns were highly local and largely invisible on the adjacent macro-electrode contacts. Spike analyses showed that the vast majority of units (n=25) were strongly modulated during all interictal patterns. The same units were involved in all 3 patterns, while showing different patterns of firing rate modulation during the interictal events.

Conclusion: These results are consistent with an altered regulation of cellular excitability and suggest that periodic patterns may result from fluctuation in inhibition and rebound excitation in the same neuronal network.

Disclosure: This study was supported by the program "Investissements d'avenir" ANR-10-IAIHU-06, and grants from the OCIRP-ICM and the Fondation de l'APHP pour la Recherche - Marie-Laure PLV Merchandising.

EPR1085

20-year experience with Vagus Nerve Stimulation Therapy for drug-resistant epilepsy in a single centre.

I. Garamendi¹, M.J. Martínez González², L. Galbarriatu Gutiérrez³, A. Marinas Alejo¹, I. Pomposo Gastelu³, C. Santos Sánchez⁴, J.C. Gómez Esteban¹, A. García Ribes⁵, M. Sánchez Horvath⁶, T. Pérez Concha¹, J. Altamirano Cruz³, A. Rodríguez-Antigüedad Zarrantz⁷
¹Neurology, Cruces University Hospital, Barakaldo, Spain, ²Child Neurology, Cruces University Hospital, Baracaldo, Spain, ³Neurosurgery, Cruces University Hospital, Barakaldo, Spain, ⁴Neurophysiology, Cruces University Hospital, Baracaldo, Spain, ⁵Child Neurology, Cruces University Hospital, Barakaldo, Spain, ⁶Neurophysiology, Cruces University Hospital, Barakaldo, Spain, ⁷Neurology, Cruces University Hospital, Baracaldo, Spain

Background and aims: To analyse the efficacy and tolerability of Vagus Nerve Stimulation (VNS) Therapy as treatment for drug-resistant epilepsy (DRE).

Methods: A retrospective study including patients which started VNS Therapy for DRE at Cruces University Hospital from 1998 to 2018 was performed. The following data were collected: age, seizure and epilepsy types, number of previous and concomitant anti-epileptic drugs (AEDs), monthly seizure frequency and adverse events at 6 and 12 months and last follow-up visit. Good response was defined as a $\geq 50\%$ reduction in monthly seizure frequency compared with the baseline.

Results: 104 patients were included. All but 2 had the electrode implanted in the left vagus nerve. 14 patients were younger than 12 years. 92% suffered from partial onset epilepsy, and were experiencing a median number of 14.5 seizures per month. Median number of AEDs used in the past was 8. Median number of concomitant AEDs was 3. Median treatment duration was 57.8 months. The responder rate was 30 % at 6 months, 34.6% at 12 months and 44% at last follow-up visit. Adverse events were experienced by 39.4%, the most common being hoarseness. Right sided VNS did not lead to cardiovascular adverse effects. VNS Therapy was discontinued in 34%, mostly due to lack of efficacy. Fibrosis and infection led to the device removal in 7 patients.

Conclusion: In this long term study, VNS Therapy showed efficacy in 44% of patients with DRE. Tolerability was good, and right sided VNS did not lead to hemodynamic adverse effects.

Disclosure: Nothing to disclose

EPR1086

Predictive factors of recurrent Status Epilepticus. A 35-year cohort study

T. Garcea¹, E. Ferlazzo¹, S. Gasparini², S.M. Cavalli³, M. Ascoli¹, G. Mastroianni¹, S. Neri¹, C. Lobianco¹, V. Cianci⁴, U. Aguglia⁵

¹University Magna Grecia, Catanzaro, Italy, ²Magna Graecia University, Catanzaro, Reggio Calabria, Italy, ³Medical and Surgical Sciences Department, School of Medicine, Magna Graecia University of Catanzaro, Catanzaro, Regional Epilepsy Centre, Great Metropolitan Hospital, Reggio Calabria, Catanzaro, Italy, ⁴Great Metropolitan Hospital, Reggio Calabria, Italy, ⁵Reggio Calabria, Reggio Calabria, Italy

Background and aims: It is well-known that status epilepticus (ES) is associated with high short and long-term morbidity and mortality. The risk of developing recurrent SEs is also known, but the predictors are poorly defined. This study aims at identifying the factors associated with the occurrence of ES in patients with a diagnosis of epilepsy and the predictors of its recurrence.

Methods: We enrolled 252 patients with at least one ES that were consecutively observed at our center in the period going from 1983 to 2018 (median follow-up 3,16 years); in addition, a randomized selection of 714 patients with epilepsy diagnosed without ES history was enrolled, with a 3:1 ratio. Different clinical-demographic variables were evaluated and were then included in a univariate/multivariate logistic regression model and a Cox regression model.

Results: The occurrence of ES was independently correlated with age of onset of ES ($p < 0.001$; OR 1.018; 95% CI 1.010-1.026), absence of known etiology ($p < 0.001$; OR 0.231; 95% CI 0.153-0.348) and number of anti-epileptic drugs taken at the last observation ($p < 0.01$; OR 1.4; 95% CI 1.19-1.69). Interestingly, the recurrence of ES was negatively correlated to its onset in an acute symptomatic context ($p = 0.034$; OR 0.26; 95% CI 0.075-0.906).

Conclusion: Late onset and the presence of a known etiology predict the occurrence of ES in a large cohort of patients. The occurrence of the 1st ES in an acute symptomatic context reduces the risk of recurrence.

Disclosure: Nothing to disclose

EPR1087

Impact of epilepsy training on school teachers and counselors: an intervention study in Lebanon

K. Abou Khaled¹, M. Ibrahim¹, R. Moussa²

¹Neurology, Hotel-Dieu de France Hospital, Saint-Joseph University, Beirut, Lebanon, ²Neurosurgery, Hotel-Dieu de France Hospital, Saint-Joseph University, Beirut, Lebanon

Background and aims: The study evaluated the immediate impact of an epilepsy training through the administration of a questionnaire on the attitudes and knowledge of teachers and counselors before and immediately after the intervention in public and private schools in Lebanon.

Methods: This project is part of an epilepsy awareness campaign in Lebanon applied to teachers and counselors in a 1.5-3-hour session. It consisted of a pretest, a unified and interactive Powerpoint conference and a posttest. The statistical analysis used the McNemar and Stuart Maxwell tests with a statistical significance level of 0.05.

Results: 73 participants completed the pre and posttest questionnaires. The majority were female (68.5%) aged <39 years (57%). A positive impact of the training was found, regardless of its duration, by comparing the pre- and postintervention results of questions relating to the effect of epilepsy on schooling, the manifestations of seizures, their psychological or behavioral effects, seizure 1st aid and the possibility of curing epilepsy with surgery. Most of our teachers recognized that children with epilepsy have a comparable IQ to others. They had a poor discriminatory attitude against people with epilepsy in terms of the direct attitude towards them or hiring them. However, 24% preferred avoiding marrying a person with epilepsy, and this was not modified by the training.

Conclusion: This is 1 of few studies worldwide and the 1st in Lebanon to demonstrate an immediate positive effect of training on epilepsy among school teachers using an arabic questionnaire. Future research should be undertaken to develop robust training models to destigmatize epilepsy.

Disclosure: Nothing to disclose

Headache and pain 1

EPR1088

Characterisation of prescription patterns in episodic and chronic migraine patients starting treatment in a real life setting with erenumab in Germany (SPECTRE) – A real world evidence study

C. Gaul¹, M. Koch², C. Baufeld²

¹Migraine and Headache Clinic, Koenigstein, Germany, ²Nuremberg, Germany

Background and aims: Antibodies as prophylaxis are novel in the migraine field, thus it is important to collect information about their application in the local clinical routine outside of randomized controlled trials. Erenumab, a Calcitonin Gene-Related Peptide (CGRP)-receptor antagonist, was approved with two monthly dosages: 70mg and 140mg. The aim of the SPECTRE study is to understand the choice of the starting dose as well as dose switching based on migraine characteristics and comorbidities.

Methods: This is an observational, non-interventional, multicenter, open label, single arm study comprising migraine patients receiving erenumab treatment. The study is conducted at 150 centers in Germany and aims to enroll 1960 adult migraine patients. Patients either can be new on the treatment or have started treatment recently, but not more than 3 months before entering the study. Apart from a headache diary, the patient-reported-outcome questionnaires HIT-6 and TSQM are used to assess the efficacy of erenumab and the satisfaction of the patients with the drug.

Results: The results of the 1st interim analysis of 100 patients will be presented. This will include patients' baseline migraine characteristics as well as the percentage of patients on each starting dose of erenumab stratified by the major reasons for prescription and comorbidities.

Conclusion: The SPECTRE study will give us valuable insights into the clinical routine of erenumab prescriptions in Germany. Characterization of the prescription pattern and analysis of the respective therapy response will possibly allow to develop individual treatment strategies for each patient.

Disclosure: Charly Gaul received honoraria for consulting and lectures within the past 3 years from Allergan Pharma, Ratiopharm, Boehringer Ingelheim Pharma, Eli Lilly, Novartis Pharma, Desitin Arzneimittel, Cerbotec, Bayer Vital, Hormosan Pharma, electroCore, Grünenthal, Reckitt Benckiser, and Teva. He does not hold any stocks of pharmaceutical companies or medical device companies. Mirja Koch and Caroline Baufeld are employees of Novartis Pharma GmbH. This study was funded by Novartis Pharma GmbH, Nürnberg, Germany.

EPR1089

Onabotulinumtoxin A Treatment Improved Health-Related Quality of Life in Adults with Chronic Migraine in the PREDICT Study: Results from Study Completers

G. Boudreau¹, I. Finkelstein², C. Graboski³, M. Ong⁴, S. Christie⁵, K. Sommer⁶, M. Bhogal⁷, G. Davidovic⁷, W. Becker⁸

¹Centre Hospitalier Universitaire de Montréal (CHUM), Montreal, Canada, ²Toronto Headache & Pain Clinic, Toronto, Canada, ³Island Health, Brentwood Bay, Canada, ⁴St Paul Hospital, Vancouver, Canada, ⁵Neurology, University of Ottawa, Ottawa, Canada, ⁶Allergan plc, Marlow, United Kingdom, ⁷Allergan plc, Markham, Canada, ⁸University of Calgary, Calgary, Canada

Background and aims: The PREDICT study aimed to assess long-term health-related quality of life (HRQOL) in Canadian adults with chronic migraine (CM) treated with onabotulinumtoxin A.

Methods: Canadian, multicentre, prospective, observational study (NCT02502123) in adults naïve to onabotulinumtoxin A for CM. Onabotulinumtoxin A (155-195U recommended) was administered every ~12 weeks over 2 years (7 cycles), per the Canadian product monograph. Primary endpoint: mean change in Migraine-Specific Quality of Life (MSQ) Tx4 vs. baseline. Secondary endpoint: headache days (daily headache diary). Unless noted, data presented as mean(SD); number of patients (n).

Results: 197 participants were enrolled; 123 (62.4%) completed all 7 treatment cycles and 74 (37.6%) discontinued the study (lost to follow-up [n=23], withdrew consent [n=8], adverse event [n=3], non-compliance [n=2], protocol violation [n=1], other [n=37]). 184 participants (average 45 years, predominantly female [84.8%] and Caucasian [94.6%]) received ≥1 treatment with onabotulinumtoxin A. At baseline, participants reported 20.9 (6.7) headache days/month, which decreased over time (range: -3.5 [6.3] at Tx1 [n=184] to -6.5 [6.6] at Tx4 [n=150]; all timepoints versus baseline, p<0.0001). Significant increases in MSQ post-Tx4 (n=150; restrictive: 21.5 [24.3], preventive: 19.5 [24.7], emotional: 22.9 [32.9]) were observed versus baseline, exceeding minimal important differences (all, p<0.0001). Additionally, completers reported 20.1 (6.7) headache days/month at baseline, which decreased over time (range: -3.9 [6.3] Tx1 [n=109] to -6.5 [6.5] Tx4 [n=107]; all timepoints versus baseline, p<0.0001). Significant increases in MSQ post-Tx4 (n=123; restrictive: 22.5 [23.5], preventive: 21.2 [24.7], emotional: 25.8 [32.7]) were also observed versus baseline in completers, exceeding minimal important differences (all, p<0.0001).

Conclusion: Real-world data from PREDICT demonstrate that onabotulinumtoxinA treatment for CM reduced headache days and improved HRQOL, with even greater improvements observed in study completers following long-term treatment.

Disclosure: This study was sponsored by Allergan Inc., Markham, Ontario, Canada.

EPR1090

Eptinezumab Reduced the Frequency of Migraine Days in Patients with Chronic Migraine and Medication-Overuse Headache: Subgroup Analysis of PROMISE-2

H.-C. Diener¹, M. Marmura², J. Hirman³, L. Mehta⁴, T. Brevig⁵, E. Brunner⁶, R. Cady⁴

¹Institute for Medical Informatics, Biometry and Epidemiology, Medical Faculty of the University Duisburg-Essen, Essen, Germany, ²Jefferson Headache Center, Thomas Jefferson University Hospitals, Philadelphia, PA, USA, ³Pacific Northwest Statistical Consulting, Inc., Woodinville, WA, USA, ⁴Lundbeck Seattle BioPharmaceuticals, Inc., Bothell, WA, USA, ⁵H. Lundbeck A/S, Copenhagen, Denmark, ⁶Lundbeck LLC, Deerfield, IL, USA

Background and aims: Eptinezumab is a monoclonal antibody that inhibits CGRP for the prevention of migraine. This analysis evaluated the impact of eptinezumab on migraine frequency in patients with chronic migraine (CM) and medication-overuse headache (MOH) in the pivotal PROMISE-2 study.

Methods: PROMISE-2 randomized patients with CM to eptinezumab 100mg, 300mg, or placebo for 2 intravenous doses administered every 12 weeks. Trained investigators diagnosed MOH at screening based on 3 months of medication history and ICHD-3b criteria. Endpoints included change from baseline in monthly migraine days (MMDs) and $\geq 50\%$ and $\geq 75\%$ migraine responder rates over Weeks 1-12 and 13-24. In addition, during Days 1-7, the percentage of patients experiencing migraine was calculated.

Results: Of 1072 patients with CM treated, 431 (40.2%) were diagnosed with MOH (100mg, n=139; 300mg, n=147; placebo, n=145). During the 28-day baseline period, MOH patients experienced 16.7 migraine days (each arm). Over Weeks 1-12, eptinezumab-treated patients experienced greater reductions from baseline in MMDs than placebo patients (100mg, 8.2; 300mg, -8.5; placebo, -5.2). About twice as many eptinezumab-treated patients were $\geq 50\%$ (60.4%; 61.9%; 34.5%) or $\geq 75\%$ migraine responders (27.3%; 29.9%; 14.5%). Similar results were observed during Weeks 13-24. The percentage of patients experiencing migraine on Days 1 through 7 was lower with eptinezumab than placebo (baseline: ~59.7% across groups; Day 1: 27.8%; 30.1%; 45.5%).

Conclusion: Eptinezumab is efficacious in patients diagnosed with CM and MOH, with greater reductions in migraine days compared with placebo at week 12, and with effect as early as Day 1 and sustained through 24 weeks.

Disclosure: H. Lundbeck A/S, Copenhagen, Denmark

EPR1091

Etiological Diversity of 2ndary Trigeminal Neuralgia

O. Carranza¹, A. Munguia², M. Segura², A. Maldonado²
¹Morelia, Mexico, ²Hospital Angeles, Morelia, Mexico

Background and aims: According to the American Academy of Neurology trigeminal neuralgia (TN) is classified regarding its etiology in classical, 2ndary to another disease and idiopathic when the cause is unknown. Although the 1st class represents about 70% of the total, there is a wide variety of diseases that can affect the trigeminal nerve and cause a 2ndary neuralgia. The aim of our study was to review and discuss all the causes of this type of TN seen in our clinic in the last 6 years.

Methods: A prospective recollection of all the cases of TN seen in our clinic from Jan 2014-Dec 2019 was performed. Patients diagnosed with classical or idiopathic TN were excluded from the final analysis and the frequency of each cause of secondary TN was registered.

Results: 1592 cases of TN were seen in our clinic between 2014-2019 of which 254 were 2ndary. We found 28 different causes of 2ndary TN, the most common pathologies were: migraine (16%), epidermoid cyst (12%), post-herpetic (10%), meningioma (9%) and multiple sclerosis (8%). Other causes found were: AVM, neurinoma, stroke, SLE, ALS and Catamenial TN.

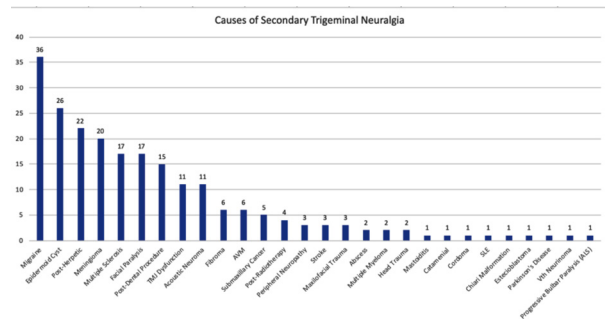

Causes of 2ndary TN

Conclusion: TN can be 2ndary to a wide variety of diseases. It is important to always keep in mind that even though the majority of cases are due to a neurovascular contact, it is always wise to obtain a full clinical history and perform a proper physical examination complemented with a MRI in each patient, in order to rule out other causes in which the treatment and prognosis varies considerably.

Disclosure: Nothing to disclose

EPR1092

Pooled Analysis of Tolerability With Fremanezumab Treatment in Patients With Episodic or Chronic Migraine and Cardiovascular Medication Use at Baseline

G. Coppola¹, J.M. Cohen², X. Ning², Y. Kessler², R. Yang², P. Barbanti³

¹Department of Medico-Surgical Sciences and Biotechnologies, Sapienza University of Rome Polo Pontino, Latina, Italy, ²Teva Branded Pharmaceutical Products R&D, Inc., West Chester, PA, USA, ³Department of Neurological, Headache and Pain Unit, IRCCS San Raffaele Pisana, Rome, Italy

Background and aims: Fremanezumab, a fully-humanised monoclonal antibody (IgG2Δa) that selectively targets calcitonin gene-related peptide (CGRP), has proven efficacy for preventive treatment of migraine in adults. Adverse events (AEs) were evaluated in a subgroup of patients with episodic migraine (EM) or chronic migraine (CM) and cardiovascular (CV) medication use at baseline in this pooled analysis of phase 3 trials of fremanezumab.

Methods: This analysis included data from three phase 3 trials (HALO EM, HALO CM, and FOCUS), in which patients were randomised 1:1:1 to subcutaneous quarterly or monthly fremanezumab or matched monthly placebo over 12 weeks. AEs reported for patients with baseline CV medication use were evaluated.

Results: Overall, 280 of 2,842 patients across these 3 studies were receiving CV medications at baseline, with similar proportions receiving CV medications across all treatment groups (9-11%). The most common type of CV medications used were agents acting on the renin-angiotensin system (3-4% across all treatment groups) and beta-blockers (3-4%). The most common AEs were injection-site-related (pain, erythema, and induration; Table). Cardiac disorder AEs were infrequent across all treatment groups (placebo, <1%; quarterly fremanezumab, 0%; monthly fremanezumab [675/225/225mg], 2%; monthly fremanezumab [225/225/225mg], 0%), as were vascular disorder AEs (0%, 1%, 6%, and 0%, respectively). No new safety signals were identified over 12 weeks of double-blind treatment.

Conclusion: This pooled analysis demonstrates that fremanezumab treatment over 12 weeks was well tolerated, with low and similar cardiac and vascular disorder AEs to placebo, in patients with migraine using CV medications at baseline.

Table. AEs With an Occurrence ≥5% of Patients in Any Treatment Group.

n (%)	Placebo (N=102)	Quarterly fremanezumab		Monthly fremanezumab	
		675mg/placebo (N=87)	675mg/225mg/225mg (N=54)	225mg/225mg/225mg (N=37)	225mg/225mg/225mg (N=37)
Patients with ≥1 AE	54 (53)	57 (66)	38 (70)	20 (54)	20 (54)
Injection-site pain	19 (19)	25 (29)	10 (19)	8 (22)	8 (22)
Injection-site erythema	10 (10)	17 (20)	7 (13)	5 (14)	5 (14)
Injection-site induration	8 (8)	16 (18)	12 (22)	10 (27)	10 (27)
Upper respiratory tract infection	5 (5)	3 (3)	3 (6)	3 (8)	3 (8)
Nasopharyngitis	3 (3)	5 (6)	4 (7)	3 (8)	3 (8)
Injection-site hemorrhage	2 (2)	2 (2)	3 (6)	1 (3)	1 (3)

AE, adverse event.

Disclosure: This study was funded by Teva Pharmaceuticals.

EPR1093

Spinal nociceptive modulation and lipid mediators levels during the glyceril trinitrate induction test in episodic migraine patients

R. De Icco¹, R. Greco², C. Demartini², A.M. Zanaboni³, A. Reggiani⁴, N. Realini⁴, M. Allena⁵, D. Martinelli¹, V. Grillo⁶, G. Sances⁵, C. Tassorelli¹

¹Headache Science Centre - Department of Brain and Behavioral Sciences, IRCCS Mondino Foundation - University of Pavia, Pavia, Italy, ²Laboratory of Neurophysiology of Integrative Autonomic Systems, IRCCS Mondino Foundation, Pavia, Italy, ³Laboratory of Neurophysiology of Integrative Autonomic Systems - Department of Brain and Behavioral Sciences, IRCCS Mondino Foundation - University of Pavia, Pavia, Italy, ⁴Department of Drug Discovery and Development, Istituto Italiano di Tecnologia, Genoa, Italy, ⁵Headache Science Centre, IRCCS Mondino Foundation, Pavia, Italy, ⁶IRCCS Mondino Foundation, Pavia, Italy

Background and aims: A derangement of the nociceptive system control as the disease progresses was found in migraine subjects. The endocannabinoids and their congeners may modulate the nociceptive pathways. Here, we evaluated the facilitation of nociceptive spinal modulation, anandamide (AEA) and palmitoylethanolamide (PEA) release, in patients affected by episodic migraine after glyceryl trinitrate (GTN) administration.

Methods: We enrolled 20 patients (33.8±8.4 years, 17 female) and 17 healthy controls (HC - 29.5±7.7, 12 female). In patients with a negative induction test (MIG-) and in HC, nociceptive withdrawal reflex, AEA and PEA plasma levels were recorded at baseline and 30, 60 (T-60) and 120 (T-120) minutes after sublingual GTN administration. Patients with a positive induction test (MIG+), were evaluated when a specific migraine-like headache reached an intensity of 5 on a 0-10 nociceptive rating scale (T-MIG) and after 1 hour (T-1h).

Results: 10 patients developed a migraine-like headache after GTN administration. The average latency of migraine onset was 63.0±55.0 minutes, therefore T-MIG and T-1h were compared with T-60 and T-120 respectively. After GTN, spinal sensitization was identified in MIG+ and MIG-, described as a decrease of single stimuli and temporal summation thresholds (p=0.016 and 0.001, respectively). After GTN, PEA levels significantly increased only in MIG+ patients at T-1h (p=0.031 vs baseline). AEA levels significantly increased in all subjects at T-120/T-1h (p=0.035 vs baseline), without significant differences between groups. Central sensitization parameters and lipid mediators' levels didn't correlate at each time point.

Conclusion: PEA release appears to be associated to the pain of migraine attack, as compensatory anti-inflammatory/analgesic mechanism.

Disclosure: Nothing to disclose

EPR1094

CGRP plasma levels and peripheral expression of specific microRNAs in chronic migraine with medication-overuse: changes induced by detoxification

R. Greco¹, C. Demartini¹, A.M. Zanaboni², E. Tumelero¹, R. De Icco¹, G. Sances¹, M. Allena¹, C. Tassorelli³
¹Headache Science Centre, IRCCS C. Mondino Foundation, Pavia, Italy, ²Dept. of Brain and Behavioral Sciences, University of Pavia, Pavia, Italy, ³Pavia Headache Centre, C. Mondino National Institute of Neurology Foundation, IRCCS, Dept. of Brain and Behavioral Sciences University of Pavia, Pavia, Italy

Background and aims: Chronic migraine (CM) is frequently associated to symptomatic medication overuse (MO) but the mechanisms underlying the development of MO remain unknown. Calcitonin gene related peptide (CGRP) is involved in sensitization phenomena and likely, in migraine chronification. MicroRNA expression patterns may useful as disease biomarkers and for predicting individual risks of chronic pain.

Methods: We evaluated CGRP plasma levels and the expression of miR-34a-5p and miR-382-5p in peripheral blood mononuclear cells of subjects with episodic migraine (EM, N=30) and CM-MO (N=27), to investigate their role in reduction of headache frequency. CM-MO group was tested at baseline and 2 months after detoxification.

Results: Baseline levels of CGRP and microRNAs were significantly higher in CM-MO subjects compared with EM patients. All the CM-MO subjects completed successfully the detoxification and were overuse-free at 2 months. During the follow-up we recorded an overall 50% decrease in headache days/month reduction (26.23±5.24 vs 13.4±10). When stratifying the CM-MO group after detoxification in EM and CM, based on the mean headache number days during the 2-month follow-up (<15 or >15), in the EM (n=15) group, we found that both CGRP and microRNAs levels were significantly reduced as compared to baseline values. By contrast, in the CM group (n=12) we only observed a decrease in microRNAs, while CGRP plasma levels did not differ from baseline.

Conclusion: Increased CGRP plasma levels are associated to migraine severity, whereas miR-34a-5p and miR-382-5p changes are a consequence of MO.

Disclosure: This study was supported by Italian Ministry of Health to IRCCS Mondino Foundation, Pavia, Italy (RC19015D).

EPR1095

The Humanistic Disease Burden of Episodic and Chronic Migraine in France, Spain and the United Kingdom

S. Díaz-Insa¹, S. Santos², H. Benhaddi³, L. Lee⁴, P.J. Goadsby⁵

¹Hospital Universitari i Politècnic La Fe, Valencia, Spain, ²Hospital Clinico Lozano Blesa, Saragossa, Spain, ³TEVA Pharma, Wilrijk, Belgium, ⁴Kantar, San Mateo, CA, USA, ⁵NIHR-Wellcome Trust King's Clinical Research Facility, King's College London, London, United Kingdom

Background and aims: Migraine is a disabling disease affecting 14% of the population worldwide. Real-world data were collected on patients with episodic migraine (EM) and chronic migraine (CM) who had failed ≥ 2 preventive treatments in the UK, France, and Spain, with a focus here on health-related quality-of-life (HRQoL) outcomes.

Methods: A cross-sectional, web-based survey was conducted among eligible patients with EM and CM in the UK, France, and Spain. HRQoL was assessed using the Migraine Disability Assessment (MIDAS) and EuroQol 5-Dimension 5-Level (EQ-5D-5L) questionnaire (assessed for health “today” and during most recent migraine headache). Descriptive statistics were calculated at the country level and qualitatively compared across countries.

Results: Patients (n=316) were included from the UK (n=106; 80EM), France (n=105; 80EM), and Spain (n=106; 80EM). Of the CM patients, 63% were female, while of the EM patients, 48% were female. CM patients experienced greater migraine disability versus EM patients (median MIDAS score, 30 vs 12). For their most recent migraine, CM patients reported lower health status than EM patients, based on the EQ-5D-5L visual analog scale (median, 40 vs 60) and total index (median, 0.35 vs 0.52) scores. Among EM patients, MIDAS scores were highest in Spain (median, 19) followed by France (13) and the UK (8). EQ-5D-5L index scores for most recent migraine were comparable across countries (median, UK, 0.57; Spain, 0.55; France, 0.41).

Conclusion: Results reveal substantial migraine disability among patients who have failed previous preventive therapies and that unmet needs may be greater in certain countries.

Disclosure: This study was funded by Teva Pharmaceuticals.

EPR1096

Procalcitonin levels in chronic migraine patients

C. Dominguez Vivero¹, Y. Leira², M. Saavedra-Piñeiro¹, X. Rodríguez-Osorio¹, M. Pérez-Mato³, T. Sobrino-Moreiras³, F. Campos-Pérez³, J.A. Castillo Sanchez⁴, R. Leira Muiño⁴

¹Neurology, Hospital Clínico Universitario de Santiago de Compostela, Santiago de Compostela, Spain, ²Dental Institute, UCL Biomedical Research Center, London, United Kingdom, ³Neurology, Laboratorio de Investigación de Neurociencias Clínicas, Instituto de Investigación Sanitaria (IDIS), Santiago de Compostela, Spain, ⁴Santiago de Compostela, Spain

Background and aims: Procalcitonin (proCT) is a peptide released in situations of stress such as sepsis or major trauma. It is coded by the same gene as calcitonin-gene related peptide (CGRP), located in chromosome 11. According to current research, CGRP is the main molecular biomarker for migraine. Our aim is to evaluate the levels of proCT in chronic migraine (CM) patients and to correlate them with biomarkers of systemic inflammation such as interleukin-6 (IL-6) and C-reactive protein (CRP) and biomarkers of neurogenic inflammation such as soluble TNF-like weak inducer of apoptosis (sTWEAK) and calcitonin-gene related peptide (CGRP).

Methods: Cross-sectional study including 117 CM (ICHD2013) patients (48.6±11.2 years old; 97.4% women) and 70 healthy controls (47.4±10.7 years old; 97.1% women). Blood samples were obtained during interictal periods and levels of proCT were determined by electroquimioluminescence. Levels of IL-6, CRP, sTWEAK and CGRP were determined by ELISA. Results were compared using T-test and One-Way ANOVA and associations were evaluated by adjusted logistic regression.

Results: ProCT levels were significantly higher in CM patients (0.040±0.019 vs. 0.030±0.023ng/ml; p=0.003). Pro-CT levels were correlated with CGRP levels (r=0.498, p<0.001), but no correlation was found with IL-6, sTWEAK or CRP levels.

Conclusion: Our results point to a possible role of proCT as an inflammation-related biomarker in CM and a proxy biomarker of CGRP levels in this pathology.

Disclosure: Nothing to disclose

EPR1097

Retrospective cohort study of patients with predominantly nocturnal headache.

F. Dourado Sotero¹, M. Leal Rato¹, I. Pavão Martins²
¹Lisbon, Portugal, ²Language Research Laboratory, Lisbon Faculty of Medicine, Lisbon, Portugal

Background and aims: Hypnic headache is a rare primary headache characterized by strictly sleep-related attacks yet, there is also an ill-defined group of patients with predominantly nocturnal headache (PNH), without criteria for hypnic headache or other entity.

Methods: Retrospective analysis of a cohort of adults with PNH identified through screening of medical records of a tertiary hospital headache clinic. Demographic variables, pain characteristics, previous and current acute and prophylactic medications, days of analgesic usage, and previous history of headache were collected.

Results: We identified 30 patients with PNH (25 females; mean age of onset 56.8 years (σ=9,4), 16 (64%) postmenopausal). Patients had a median of 17.3 days (IQR=9-30) of headache per month, occurring mostly between 2 and 4am. All patients had a moderate to severe pain that lasted more than 15 minutes and 12 patients had features of migraine. Half of them had tried 3 or more prophylactics, usually without clinically significant improvement, and 14 (46%) patients filled the criteria for medication-overuse headache (MOH). 21 (70%) patients had a previous diagnosis of migraine: in 12 the pain changed characteristics and became nocturnal; in 6 it disappeared before onset of a new strictly nocturnal pain and in 3 patients it became diurnal and nocturnal.

Conclusion: PNH is frequently associated with a history of migraine. It can lead to MOH because of its severity and the lack of response to prophylactics. Whether envisioned as part of migraine natural history or as a new entity, more studies on PNH are needed to optimize management of these patients.

Disclosure: Nothing to disclose

Headache and pain 2

EPR1098

Real-world Trends in Characteristics of Migraine Patients Newly Initiated on Erenumab in the United States

J. Fang¹, S. Korrer², J. Johnson², P. Vo³, A. Cheadle¹, R. Shah¹, M. Ferraris³, C. Lopez Lopez³

¹Novartis Pharmaceuticals Corporation, East Hanover, NJ, USA, ²Optum, Eden Prairie, MN, USA, ³Novartis Pharma AG, Basel, Switzerland

Background and aims: Erenumab-aooe (erenumab; Aimovig[®]) is indicated for the preventive treatment of migraine in adults. While its efficacy and safety in migraine patients have been evaluated in multiple clinical trials, real-world use of erenumab has not been fully investigated. This retrospective analysis aimed to characterise migraine patients initiating erenumab in real-world setting using a US electronic health record (EHR) database.

Methods: Adult patients with ≥ 1 erenumab written prescription/administration between 5/1/2018-3/31/2019 were identified from Optum EHR database (index date=date of the 1st erenumab prescription/administration). Patient characteristics and initial prescriber specialty were assessed. The real-world trend of the patients' profile was assessed by the month of erenumab initiation.

Results: This study included 10,076 patients initiating erenumab; female (86.3%), average age 46.5 (standard deviation=13.0) years, patients were most commonly Caucasian (87.9%), Non-Hispanic (90.6%) and commercially insured (60.8%) at the index date. Commonly observed comorbid conditions during the 12-month pre-index period were anxiety (29.1%), depression (29.0%), and hypertension (21.7%). The mean Elixhauser comorbidity score in the 12-month pre-index period decreased over the month of erenumab initiation (Figure 1). More neurologists/headache specialists than general practitioners initiated erenumab in more severe migraine patients. Over time, there was an increase in general practitioners' prescribing erenumab, and prescription in less severe migraine patients (a proxy of declining trend in chronic migraine and triptan use) (Figure 2).



SD, standard deviation

Note:

The Elixhauser comorbidity index measures the baseline comorbidity based on inpatient and outpatient administrative claims data. The score is generated via the summation of points from each disease and the range of possible scores is from -19 (lesser disease burden) to +89 (greater disease burden).

Figure 1. Elixhauser comorbidity score assessed over 12-month pre-index period in patients initiating erenumab over time

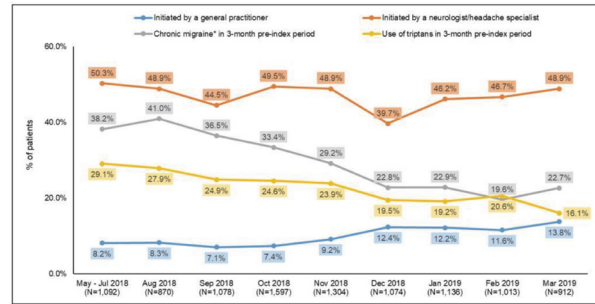

* Diagnosis code of chronic migraine without aura was used.

Figure 2. Initial prescriber specialty, chronic migraine diagnosis & triptan use prior to erenumab initiation over time

Conclusion: Patients initiating erenumab had a higher comorbidity burden (anxiety, depression, and hypertension) in real-world compared with the general migraine population. Over time, a broader population of migraine patients received erenumab, and more general practitioners prescribed erenumab.

Disclosure: This study was funded by Novartis Pharma AG, Basel, Switzerland.

EPR1099

Response to prophylactic treatment in Linear Headache: a series of 16 patients

A. Chavarría-Miranda¹, D. García Azorín¹,
B. Talavera de la Esperanza², I. Hernandez Perez³,
A. Sierra Mencia¹, A.L. Guerrero Peral¹

¹Valladolid, Spain, ²Neurology, Valladolid Hospital, Valladolid, Spain, ³Headache Unit. Neurology Department, Valladolid University Hospital, Valladolid, Spain

Background and aims: Linear Headache (LH) was described in 2014 and combines features of Nummular Headache (NH) and Epicrania Fugax (EF). It is not yet clarified whether it constitutes a subtype of the former, a focal manifestation of migraine or a singular disorder. We aim to analyze the response to acute and preventive medication in LH patients.

Methods: We prospectively included patients with 1) Continuous or intermittent head pain with the following characteristics: A) Sharply contoured, B) fixed in size and shape, C) linear shape; 2) absence of movement within the trajectory; 3) no circumscription of the pain to the territory of any nerve. We describe the number of patients that used each treatment and the response, defined by 50% reduction in monthly headache days.

Results: From April 2014 to April 2019, 14 patients fulfilled criteria, being 8 of them women. Mean age at onset was 40.6±21.6 years and mean time of evolution was 6.6±10.5 years. Prophylactic treatment had been used by 13/16 patients, with a mean of 4 treatments (range 1-6). Number of patients with response per drug was 1/5 for amitriptyline, 1/3 for lamotrigine, 1/2 with betablockers, 0/3 to topiramate and 0/2 pregabalin, gabapentine, duloxetine and zonisamide. Anesthetic blockade was used in 7 patients with 1 positive response and onabotulinumtoxinA was used in 7 cases, with 50% response in all cases, being excellent (>75%) in 4.

Conclusion: Response to prophylactic in LH patients resembles more NH than EF or migraine, being onabotulinumtoxinA the treatment with the better responder rate.

Disclosure: Nothing to disclose

EPR1100

Changes in Work Productivity and Interictal Burden: Results from a Randomized, Double-Blind, Placebo-Controlled Clinical Trial Evaluating Galcanezumab in Adults with Treatment-Resistant Migraine (CONQUER)

D. García-Azorín¹, J. Ford², D. Buse³, A. Hand⁴,
L. Wietecha², H. Detke²

¹Department of Neurology, Hospital Clínico Universitario de Valladolid, Valladolid, Spain, ²Eli Lilly and Company, Indianapolis, USA, ³Department of Neurology, Albert Einstein College of Medicine, Bronx, NY, USA, ⁴IQVIA, Durham, NC, USA

Background and aims: We evaluated changes in work productivity/activity impairment and interictal burden attributed to migraine among patients treated with galcanezumab or placebo.

Methods: Patients with episodic or chronic migraine, who had multiple previous migraine preventive treatment failures, were randomized to galcanezumab 120mg/month (with a 240mg loading dose; n=232) or placebo (n=230) in this 3-month double-blind study (#NCT03559257). Absenteeism, presenteeism, work productivity loss, and activity impairment were assessed using the Work Productivity and Activity Impairment Questionnaire (WPAI) and calculated as impairment percentages; group comparison was conducted using ANCOVA. Burden between attacks was assessed using the Migraine Interictal Burden Scale (MIBS; score range 0-12; 0=none; ≥5=severe); group comparison was conducted using mixed model repeated measures.

Results: A total of 97.6% patients completed the 3-month, double-blind phase. The mean reductions of WPAI scores from baseline were significantly greater (all p≤0.0004) in the galcanezumab group compared with placebo in the percent of activity impairment (20.7% vs 8.6%), presenteeism (12.5% vs 2.6%), and overall work impairment (14.3% vs 3.5%); absenteeism was not significantly different. On the MIBS, mean change from baseline of 5.5 (indicative of severe interictal burden) was greater for the galcanezumab group (1.8) compared with placebo (0.8; p<0.0001).

Conclusion: Significantly greater reductions in migraine-related work productivity/activity impairment and interictal burden were seen in galcanezumab-treated patients relative to placebo.

Disclosure: This research was supported by Eli Lilly and Company. ClinicalTrials.gov: #NCT03559257 (15Q-MC-CGAW)

EPR1101

First data collection on the use of prophylactic migraine treatments including the monoclonal antibody Erenumab focused on the patient's personal experience

C. Gaul¹, H. Israel-Willner², K. Schuh³, M. Koch³
¹Königstein, Germany, ²Klinik für Neurologie, Berlin, Germany, ³TA Neuroscience, Novartis Pharma GmbH, Nuremberg, Germany

Background and aims: The perspective of patients regarding a new therapeutic option is not systematically captured. Quality of life including daily activity, time with the family and the wellbeing of the patient are deciding factors in migraine management. Thus, it is imperative to understand the patients' perspective on treatment with erenumab, a fully human monoclonal antibody targeting the CGRP receptor, available since November 2018 in Germany.

Methods: From July 2019 to December 2019, an online survey of German patients diagnosed with migraine collected details regarding their disease and experience with migraine therapies. Patients who had been on erenumab for at least 3 months were further asked about their treatment outcome and impact on their lives.

Results: An interim analysis covered 19740 migraine patients of which 39% had prior prophylactic treatment and 37% are using non-pharmaceutical treatments. The analysis included 91 erenumab patients with a mean of 18 years disease duration. These erenumab patients have tried 6.1 different pharmacologic prophylactic therapies on average. 85% of erenumab-patients stated that they can cope better with daily activities, 83% have fewer days lost to migraine since therapy initiation and 47% could already feel an improvement of their migraine symptoms after the 1st injection. For EAN congress, the full data set of >20,000 migraine patients will be presented.

Conclusion: PERISCOPE provides us the 1st real world data of German patients treated with erenumab and shows that patients' benefit from erenumab treatment with regard to improvement of quality of life and reduction of migraine specific symptoms.

Disclosure: This study has been funded by Novartis Pharma GmbH.

EPR1102

Galcanezumab in migraine prevention: a systematic review and meta-analysis of randomized controlled trials

P. Gklinos¹, D.-D. Mitsikostas²

¹Neurology Department, KAT General Hospital of Athens, Athens, Greece, ²Neurology, AIGINITEION HOSPITAL, Athens, Greece, Greece

Background and aims: Galcanezumab along with other three monoclonal antibodies targeting the calcitonin gene related peptide (CGRP) pathway represent the latest and the unique disease-specific and mechanism-based treatments for the prophylaxis of migraine. The aim of this study is to provide a pooled safety and efficacy analysis of all phase 3 randomized-controlled trials of galcanezumab, in the preventive therapy of migraine.

Methods: A computer-based literature search was conducted on MEDLINE and the US National Institutes of Health Clinical Trials Registry for phase 3 randomized-controlled trials of galcanezumab in migraine prevention. The primary outcome was the mean change in monthly migraine headache days (MHDs). The proportions of patients who reported at least one adverse event (AE), one serious AE or withdrew from the study were used as safety outcomes.

Results: 3 trials were included in the meta-analysis. Migraine preventive treatment with subcutaneous galcanezumab, at both 120mg and 240mg dosages, was associated with a significantly greater reduction in the mean number of monthly MHD vs. placebo (120mg MD=-1.98 95% CI=-2.33 to -1.63; p<0.0001) or (240mg MD=-1.86 95% CI=-2.2 to -1.53 p<0.0001). Galcanezumab was found to be more efficacious in all key 2ndary outcomes as well. Regarding safety, most of the adverse events were mild to moderate while drop-out rates and serious adverse events were low.

Conclusion: Galcanezumab is an efficacious and well-tolerated preventive treatment for migraine. Larger clinical trials with longer follow-up periods need to be conducted in order to provide more safety data of the above-mentioned drug.

Disclosure: Dr. P. Gklinos reports no disclosures. Dr. D.D. Mitsikostas has received honoraria, research and travel grants from Allergan, Amgen, Biogen, Cefaly, Eli Lilly, Electrocore, Mertz, Novartis, Roche, Sanofi, Specifar and Teva.

EPR1103

Natural course of Visual Snow Syndrome: a long-term follow-up studyM. Graber¹, P.J. Goadsby², A. Scutelnic¹, C. Schankin¹¹Department of Neurology, Inselspital, Bern University Hospital, University of Bern, Berne, Switzerland, ²Headache Group, Department of Basic and Clinical Neuroscience, Institute of Psychiatry, Psychology & Neuroscience, King's College London, United Kingdom, London, United Kingdom**Background and aims:** Visual Snow Syndrome (VSS) is characterized by a continuous positive pan-field visual disturbance resembling the view of a badly-tuned analogue television plus associated visual symptoms. For many patients VSS can be disabling. We present the 1st longitudinal study describing the long-term natural course of the disorder over 8 years.**Methods:** In total 78 Patients with confirmed VSS, including normal ophthalmologic exams, were followed from November 2011 to December 2019. The clinical course of the disorder was assessed in a semi-structured telephone interview.**Results:** 40 of 78 (51%) patients were reached for the follow up interview. Mean follow up time was 83.6±4.5 months. 2 of 40 (5%) reported the onset of additional visual symptoms, which were tunnel vision and light flashes. Compared to 2011, less patients rated visual snow itself as the most disturbing symptom (40% in 2019 vs 72.5% in 2011, p=0.001); instead, patients suffered more from floaters and palinopsia. New treatments were commenced in 14/40 (35%) patients. Of those, 6 (42%) were somewhat helpful: lamotrigine, diet/vitamin supplements/probiotics, lorazepam, cinnarizine, polarized glasses, chiropractic treatment. During follow up, 3 patients experienced new visual migraine aura without headache, and one had new migraine headache (total prevalence aura 35%, migraine 47.5%). There was no significant difference in anxiety and depression measured by the PHQ-8 and the GAD-7 questionnaire.**Conclusion:** In a group of patients with VSS, symptoms can persist over 8 years without spontaneous resolution. New visual symptoms can develop, but visual snow itself might get less bothersome.**Disclosure:** Nothing to disclose

EPR1104

Early Efficacy in Patients ≥60 Years of Age With Episodic or Chronic Migraine: Pooled Results of 3 Randomised, Double-blind, Placebo-controlled Phase 3 StudiesD. Holle-Lee¹, J.M. Cohen², X. Ning², L.J. Krasenbaum², R. Yang², P. Pozo-Rosich³¹West German Headache Center, University Hospital Essen, Department of Neurology, Essen, Germany, ²Teva Branded Pharmaceutical Products R&D, Inc., West Chester, PA, USA, ³Headache Unit, Neurology Department, Vall d'Hebron University Hospital, Barcelona, and Headache and Neurological Pain Research Group, Vall d'Hebron Institute of Research (VHIR), Universitat Autònoma de Barcelona, Barcelona, Spain**Background and aims:** Older patients with migraine often experience more frequent and severe side effects with migraine preventive medications. Fremanezumab, a fully-humanised monoclonal antibody (IgG2Δa) that selectively targets calcitonin gene-related peptide (CGRP), has proven efficacy for preventive treatment of migraine in adults. This pooled analysis evaluated early efficacy of fremanezumab in patients ≥60 years of age.**Methods:** This analysis in patients ≥60 years of age with episodic migraine (EM) or chronic migraine (CM) included data from 3 double-blind phase 3 trials (HALO EM, HALO CM, and FOCUS), in which patients were randomised 1:1:1 to subcutaneous quarterly or monthly fremanezumab, or matched monthly placebo over 12 weeks. Reductions from baseline in weekly migraine days and monthly headache days of at least moderate severity, and proportions of patients achieving ≥50% reduction in monthly migraine days were evaluated during the 1st 4 weeks.**Results:** Reductions from baseline in weekly migraine days were significantly greater with fremanezumab (monthly and quarterly) versus placebo by Week 1 (P<0.05; Table). Reductions in monthly headache days of at least moderate severity were significantly greater with both fremanezumab regimens versus placebo at Week 4 (P<0.05; Table). The proportion of patients achieving ≥50% reduction in monthly migraine days at Week 4 was significantly greater with quarterly fremanezumab versus placebo (P<0.05; Table).**Table. Early Efficacy of Fremanezumab in Migraine Patients ≥60 Years of Age**

	Placebo (n=80)	Quarterly fremanezumab (n=74)	Monthly fremanezumab (n=92)
Change from BL in weekly average number of migraine days at Week 1			
LSM (SE)	-0.4 (0.20)	-1.1 (0.21)	-1.1 (0.19)
LSMD (SE) versus placebo	—	-0.7 (0.27)*	-0.7 (0.26)*
Change from BL in monthly average number of headache days of at least moderate severity at Month 1			
LSM (SE)	-1.7 (0.54)	-4.3 (0.56)	-4.0 (0.51)
LSMD (SE) versus placebo	—	-2.6 (0.70)*	-2.2 (0.66)*
≥50% reduction from BL in monthly average number of migraine days at Month 1			
Proportion of patients, n (%)	18 (23)	28 (38)	32 (35)
OR (95% CI) versus placebo	—	2.15 (1.06, 4.38)*	1.86 (0.94, 3.68)

BL, baseline; LSM, least-squares mean; SE, standard error; OR, odds ratio; CI, confidence interval.
*P<0.05 versus placebo.**Conclusion:** In this pooled analysis, fremanezumab treatment demonstrated early onset of efficacy in patients ≥60 years of age with EM or CM.**Disclosure:** This study was funded by Teva Pharmaceuticals.

EPR1105

Characterization of Treatment Emergent Adverse Events in Headache Pain-Free Patients after Lasmiditan Dosing for the Acute Treatment of a Single Migraine Attack

G. Terwindt¹, A.J. Nagy², E.G. Doty³, D.D. Ruff⁴, A. Buchanan⁵, A. Hake⁶, E.M. Pearlman⁴, H.-P. Hundemer⁷

¹Neurology, Leiden University Medical Center, Leiden, Netherlands, ²Nevada Headache Institute, Las Vegas, NV, USA, Las Vegas, USA, ³Lilly USA, LLC, Indianapolis, USA, ⁴Eli Lilly and Company, Indianapolis, USA, ⁵Lilly Corporate Center, Indianapolis, USA, ⁶Lilly Corporate Center, Indianapolis U.S.A., Indianapolis, USA, ⁷Bad Homburg, Germany

Background and aims: Evaluate treatment emergent adverse events (TEAEs) of patients experiencing pain freedom, or experiencing no change/worsening of pain 2 hours after lasmiditan treatment.

Methods: Post-hoc analyses were completed using pooled data from 2 phase 3 studies, SAMURAI (2231 patients in almost 100 US-based centers) and SPARTAN (3005 patients in 125 centers in the US, UK, Germany). Migraine patients were randomized to receive placebo or lasmiditan (50 [SPARTAN only], 100, or 200mg). Fisher's exact test was used to compare overall adverse event rate of patients in each dose level group that responded at 2 hours versus corresponding group that stayed same or worsened.

Results: Top 5 TEAEs experienced by pain-free patients at 2 hours were dizziness, somnolence, paraesthesia, fatigue, hypoaesthesia. Among lasmiditan-treated patients, percentage of patients reporting ≥ 1 TEAE was higher in group experiencing pain freedom versus group who experienced no change/worsening of pain at 2 hours. A dose response in pain-free patients was observed, with greater percentages of patients reporting paraesthesia, fatigue, hypoaesthesia when treated with higher lasmiditan doses. However, only within lasmiditan 200mg-dose group, the overall adverse event rate in patients who experienced pain freedom at 2 hours was significantly higher versus the group that stayed same or got worse (44.5% vs 30.7%, $p=0.002$).

Conclusion: Lasmiditan-treated patients who experienced pain freedom reported TEAEs at a higher rate versus lasmiditan-treated patients who showed no improvement/worsening of pain. Additionally, patients treated with lasmiditan who achieved pain freedom had higher incidence of TEAEs with higher lasmiditan doses.

Disclosure: The SPARTAN and SAMURAI studies were sponsored by CoLucid Pharmaceuticals, a wholly owned subsidiary of Eli Lilly and Company, Indianapolis Indiana.

EPR1106

Healthcare Resource Utilization and Economic Burden of Migraine in the United Kingdom, France, and Spain: Results of a Real-world Study

P. Irimia¹, H. Benhaddi², F. Morand³, F. Maurel³, M. Lanteri-Minet⁴, P. Goadsby⁵

¹Clínica Universidad de Navarra, Pamplona, Spain, ²TEVA Pharma, Wilrijk, Belgium, ³IQVIA, Courbevoie, France, ⁴Pain Department, CHU Nice, FHU InovPain Côte Azur University, Nice, France, ⁵NIHR-Wellcome Trust King's Clinical Research Facility, King's College London, London, United Kingdom

Background and aims: This longitudinal, retrospective study evaluated epidemiology, pharmacologic management, resource utilization, and treatment costs (medications/consultations/diagnostic tests) for patients with episodic migraine (EM; <15-days/month, last 3-months) and chronic migraine (CM) in the UK, France, and Spain.

Methods: The patient cohort, from a representative panel of electronic medical records, included adults with a record of migraine diagnosis or specific treatment from April 2016 to March 2017. Patients were stratified, with triptan usage as a surrogate for migraine, by migraine classification (EM/CM). Patients were followed for 1-year after 1st recorded migraine diagnosis or specific migraine treatment.

Results: This study included 42,439 patients in the UK (EM, 96%), 31,250 in France (EM, 88%), and 10,577 in Spain (EM, 82%). In the UK, France, and Spain, 15.7%, 10.1%, and 2.7% of all patients, respectively, received acute and preventive treatments. During follow-up, CM patients had more mean migraine-related consultations with general practitioners than EM patients in the UK (13.9 vs 4.6), Spain (15.0 vs 5.7), and France (4.2 vs 2.5); proportions with ≥ 1 migraine-related diagnostic test were higher for CM versus EM patients in the UK (12.1% vs 7.2%) and France (25.1% vs 18.7%), but not Spain (10.7% vs 9.8%). Mean quarterly treatment costs (payer's perspective) were higher in CM versus EM patients in the UK (434.3€ vs 104.3€), France (155.7€ vs 40.8€), and Spain (98.8€ vs 111.5€).

Conclusion: Migraine is associated with substantial healthcare and economic burden, with higher resource utilization and treatment costs among CM versus EM patients in the UK, France, and Spain.

Disclosure: This study was funded by Teva Pharmaceuticals.

EPR1107

Pooled Analysis of Cardiovascular Safety With Fremanezumab Treatment in Patients With Migraine by Number of Cardiovascular or Cerebrovascular Risk Factors

T. Jürgens¹, Y. Kessler², J.M. Cohen², X. Ning², R. Yang², H.-C. Diener³

¹Dept. of Neurology, Headache Center North-East, University Medical Center of Rostock, Rostock, Germany,

²Teva Branded Pharmaceutical Products R&D, Inc., West Chester, PA, USA, ³Institute for Medical Informatics, Biometry and Epidemiology, Medical Faculty of the University Duisburg-Essen, Essen, Germany

Background and aims: Fremanezumab, a fully-humanised monoclonal antibody (IgG2Δa) that selectively targets calcitonin gene-related peptide (CGRP), has proven efficacy for the preventive treatment of migraine in adults. Overall adverse events (AEs) and cardiovascular (CV) safety of fremanezumab were evaluated in a subgroup of patients with migraine and cardiovascular/cerebrovascular risk factors (CVRFs; eg, smoking, diabetes mellitus, hyperlipidemia, obesity, hypertension, birth control pill use) at baseline.

Methods: This pooled analysis included data from 3 phase 3 trials (HALO EM, HALO CM, and FOCUS), in which patients were randomised 1:1:1 to receive subcutaneous quarterly or monthly fremanezumab or matched monthly placebo over 12 weeks. Overall AEs and cardiac and vascular disorder AEs (CVAEs) were evaluated by number of CVRFs at baseline and/or CV medical history. Patients with serious vascular diseases were excluded.

Results: In total, 499 out of 2,842 pooled patients had ≥ 2 CVRFs (0 CVRFs, n=1,350; ≥ 1 CVRF, n=1,492; ≥ 2 CVRFs, n=499; ≥ 3 CVRFs, n=183, ≥ 4 CVRFs, n=55). Of these patients, 66% had CV medical history. Common CV risk factors were hypertension, obesity, and use of hormonal birth control pills. Over 12 weeks of double-blind treatment, CVAEs were infrequent in patients with ≥ 2 or ≥ 3 CVRFs; no CVAEs were reported in patients with ≥ 4 CVRFs (Table). Incidences of CVAEs were similar in patients with and without CV medical history. No new CV safety signals were identified.

Conclusion: This pooled analysis demonstrates that fremanezumab treatment was well tolerated in migraine patients with ≥ 2 CVRFs and did not increase the risk of CVAEs compared with placebo.

Table. Overall AEs and Cardiac or Vascular Disorder AEs By Number of Cardiovascular or Cerebrovascular Risk Factors, n (%)

AEs, n (%)	Placebo (n=169)	Quarterly fremanezumab 675mg/placebo/placebo (n=174)	Monthly fremanezumab	
			675mg/225mg/225mg (n=95)	225mg/225mg/225mg (n=61)
≥ 2 CVRFs				
≥ 1 AE*	96 (57)	116 (67)	60 (63)	36 (59)
Cardiac disorders	3 (2)	1 (1)	1 (1)	0
Palpitations	0	0	1 (1)	0
Supraventricular tachycardia	0	1 (<1)	0	0
Atrial fibrillation	1 (<1)	0	0	0
Bradycardia	1 (<1)	0	0	0
Tachycardia	1 (<1)	0	0	0
Vascular disorders	1 (<1)	3 (2)	4 (4)	0
Hypertension	1 (<1)	3 (2)	1 (1)	0
Hypertensive crisis	0	0	1 (1)	0
Hypotension	0	0	1 (1)	0
Raynaud's phenomenon	0	0	1 (1)	0
≥ 3 CVRFs				
≥ 1 AE	36 (59)	48 (71)	26 (72)	7 (39)
Cardiac disorders	1 (2)	0	1 (3)	0
Palpitations	0	0	1 (3)	0
Tachycardia	1 (2)	0	0	0
Vascular disorders	1 (2)	2 (3)	2 (6)	0
Hypertension	1 (2)	2 (3)	1 (3)	0
Hypertensive crisis	0	0	1 (3)	0
≥ 4 CVRFs				
≥ 1 AE	10 (59)	14 (70)	9 (75)	2 (33)
Cardiac disorders				
Vascular disorders				
			None reported	None reported

CVRFs, cardiovascular/cerebrovascular risk factors; AE, adverse event. *Overall AEs.

Disclosure: This study was funded by Teva Pharmaceuticals.

Motor neurone diseases

EPR1108

Gene Therapy in Spinal Muscular Atrophy Type 1 (SMA1): Long-Term Follow-Up (LTFU) From the Onasemnogene Abeparvovec Phase 1 Clinical Trial

J.R. Mendell¹, R. Shell¹, K.J. Lehman², M. McColly², L.P. Lowes¹, L.N. Alfano², N.F. Miller², M.A. Iammarino², K. Church², F. Baladinetti³, F.G. Ogrinc³, H. Ouyang³, E. Kernbauer³, S. Joshi³, D.M. Sproule³, M. Meriggioli³, D.E. Feltner³, S. Al-Zaidy¹

¹Nationwide Children's Hospital; Ohio State University, Columbus, USA, ²Nationwide Children's Hospital, Columbus, USA, ³AveXis, Inc., Bannockburn, USA

Background and aims: Onasemnogene abeparvovec (formerly AVXS-101), a 1-time intravenous gene therapy, delivers a fully functional copy of the human survival motor neuron (SMN) gene that addresses the genetic root cause of SMA. In the phase 1 trial (START; NCT02122952), SMA1 patients who received an onasemnogene abeparvovec infusion at the high dose (Cohort 2, n=12) demonstrated significantly improved outcomes vs untreated natural history. Here, we evaluate long-term safety and efficacy of high-dose onasemnogene abeparvovec in patients previously treated in START.

Methods: Patients in START could rollover into a LTFU study (Study LT-001; NCT03421977). Primary objective: long-term safety. Patients have annual visits (5 years) followed by annual phone contact (additional 10 years). Patient record transfers are requested. Safety assessments include medical history and record review, physical examination, clinical laboratory evaluation, and pulmonary assessments. Efficacy assessments include evaluation of developmental milestones maintenance.

Results: 13 patients (Cohort 1, n=3; Cohort 2, n=10) enrolled (31 May 2019). All Cohort 2 patients were surviving free of permanent ventilation (mean [range] age at last follow-up: 4.2 [3.7–5.0] years; mean [range] time since dosing: 3.9 [3.5–4.6] years). No developmental milestones were lost; 2 patients achieved standing with assistance. Of the 10 enrolled Cohort 2 patients, 6 require no regular, daily respiratory support and 7 are not receiving concomitant nusinersen. No new treatment-related serious adverse events occurred (8 March 2019).

Conclusion: 1-time intravenous administration of onasemnogene abeparvovec at the high dose in START continues to provide durable efficacy with milestone development in Study LT-001.

Disclosure: AveXis, Inc., a Novartis Company, sponsored this clinical trial.

EPR1109

Onasemnogene Abeparvovec-xioi Gene Therapy in Presymptomatic Spinal Muscular Atrophy (SMA): SPR1NT Study Update

K.A. Strauss¹, M.A. Farrar², K.J. Swoboda³, K. Saito⁴, C.A. Chiriboga⁵, R.S. Finkel⁶, S.T. Iannaccone⁷, J.M. Krueger⁸, J.M. Kwon⁹, H.J. McMillan¹⁰, L. Servais¹¹, J.R. Mendell¹², J. Parsons¹³, M. Scoto¹⁴, P.B. Shieh¹⁵, C. Zaidman¹⁶, M. Schultz¹⁷, F. Baladinetti¹⁷, F.G. Ogrinc¹⁷, S. Kavanagh¹⁷, D.E. Feltner¹⁷, S. Tauscher-Wisniewski¹⁷, B.E. McGill¹⁷, D.M. Sproule¹⁷, F. Muntoni¹⁸

¹Clinic for Special Children, Children's Hospital of Pittsburgh, Strasburg, USA, ²Sydney Children's Hospital Network; UNSW Sydney, Randwick, Sydney, Australia, ³Massachusetts General Hospital for Children, Boston, USA, ⁴Tokyo Women's Medical University, Tokyo, Japan, ⁵Columbia University Medical Center, New York, USA, ⁶Division of Neurology, Department of Pediatrics, Nemours Children's Hospital, Orlando, USA, ⁷Department of Pediatrics, University of Texas Southwestern Medical Center, Dallas, USA, ⁸Helen DeVos Children's Hospital, Grand Rapids, USA, ⁹University of Wisconsin School of Medicine and Public Health, Madison, USA, ¹⁰Children's Hospital of Eastern Ontario, Ontario, Canada, ¹¹MDUK Oxford Neuromuscular Centre, Oxford, United Kingdom, ¹²Nationwide Children's Hospital; Ohio State University, Columbus, USA, ¹³University of Colorado School of Medicine, Aurora, USA, ¹⁴Great Ormond Street Institute of Child Health & Great Ormond Street Hospital, University College London, London, United Kingdom, ¹⁵Department of Neurology, David Geffen School of Medicine at UCLA, Los Angeles, USA, ¹⁶Washington University School of Medicine, St. Louis, USA, ¹⁷AveXis, Inc., Bannockburn, USA, ¹⁸Great Ormond Street Institute of Child Health & Great Ormond Street Hospital, Great Ormond Street Hospital Biomedical Research Centre; University College London, London, United Kingdom

Background and aims: SMA is caused by biallelic SMN1 deletion/mutation. Copies of SMN2 modify disease severity. This study evaluates safety/efficacy of onasemnogene abeparvovec (formerly AVXS-101) in presymptomatic SMA patients.

Methods: SPR1NT is a multicentre, open-label, phase 3 study. Asymptomatic patients expected to develop SMA (2–3xSMN2, ≤6 weeks) receive a 1-time intravenous onasemnogene abeparvovec infusion and are assessed through 18/24 (2xSMN2/3xSMN2) months. Primary outcomes: sitting ≥30 seconds/standing unassisted (2xSMN2/3xSMN2). Exploratory outcomes include CHOP INTEND.

Results: As of 31 May 2019, 23 infants were dosed (8–43 days of age [mean: 24.7]; 2xSMN2/3xSMN2/4xSMN2, n=10/12/1). All patients are alive and none required ventilation support as of last visit. Among 2xSMN2 patients, 7 achieved a full/near full CHOP INTEND score of 60–64; 9 achieved head control; 6 achieved sitting (all within the

WHO 1st–99th percentile range [3.9–9.2 months]); 3 achieved standing with assistance (mean [range]: 10.1 [8.8–12.3] months). Among 3xSMN2 patients, 11 achieved head control; 2 sat (6.3–9.0 months); 1 crawled/stood with assistance (9.0 months). No patient is delayed in standing alone or independent sitting. All patients (2x–3xSMN2) with a 6-month evaluation (12/12) had normal swallowing. As of 8 March 2019, 13/18 patients experienced ≥ 1 TEAE; treatment-related TEAEs were reported in 7/18 patients; 4/18 patients experienced TEAEs of special interest.

Conclusion: Preliminary SPR1NT data show improvements in presymptomatic SMA patients dosed with onasemnogene abeparvovec vs SMA type 1 natural history, underscoring the importance of early treatment.

Disclosure: This study was sponsored by AveXis, Inc., a Novartis company.

EPR1110

FIREFISH Part 2: Efficacy and safety of risdiplam (RG7916) in infants with Type 1 spinal muscular atrophy (SMA)

L. Servais¹, G. Baranello², R. Masson³, M. Mazurkiewicz-Beldzińska⁴, K. Rose⁵, D. Vlodayets⁶, H. Xiong⁷, E. Zanoteli⁸, M. El-Khairi⁹, S. Fuerst-Recktenwald¹⁰, M. Gerber¹¹, K. Gorni¹², H. Kletzl¹¹, R. Scalco¹⁰, B.T. Darras
On Behalf Of The Firefish Working Group¹³

¹MДУK Oxford Neuromuscular Centre, Oxford, United Kingdom, ²The Dubowitz Neuromuscular Centre, UCL Great Ormond Street Institute of Child Health, London, United Kingdom, ³Developmental Neurology Unit, Carlo Besta Neurological Research Institute Foundation, Milan, Italy, ⁴Developmental Neurology, Medical University of Gdansk, Gdansk, Poland, ⁵Paediatric Gait Analysis Service of New South Wales, The Children's Hospital at Westmead, Sydney, Australia, ⁶Russian Children Neuromuscular Center, Veltischev Clinical Pediatric Research Institute of Pirogov Russian National Research Medical University, Moscow, Russian Federation, ⁷Department of Pediatrics, Peking University First Hospital, Beijing, China, ⁸Hospital das Clinicas, São Paulo, Brazil, ⁹Roche Products Ltd, Welwyn Garden City, United Kingdom, ¹⁰Pharma Development Neurology, F. Hoffmann-La Roche Ltd, Basel, Switzerland, ¹¹Roche Pharmaceutical Research and Early Development, Roche Innovation Center Basel, Basel, Switzerland, ¹²PDMA Neuroscience and Rare Disease, F. Hoffmann-La Roche Ltd., Basel, Switzerland, ¹³Boston Children's Hospital, Harvard Medical School, Boston, USA

Background and aims: Spinal muscular atrophy (SMA) is a severe, progressive neuromuscular disease caused by reduced levels of survival of motor neuron (SMN) protein due to deletions and/or mutations of the SMN1 gene. A second gene, SMN2, produces only low levels of functional SMN protein. Risdiplam (RG7916) is an orally administered, centrally and peripherally distributed SMN2 pre-mRNA splicing modifier that increases the levels of functional SMN protein. Part 2 of the FIREFISH study (NCT02913482) aims to determine the efficacy and safety of risdiplam in infants with Type 1 SMA.

Methods: FIREFISH is an ongoing, multicentre, open-label study of risdiplam in infants aged 1–7 months at enrolment with Type 1 SMA and two SMN2 gene copies. Part 1 (n=21) assesses the safety, tolerability, pharmacokinetics and pharmacodynamics of different risdiplam dose levels (plus exploratory efficacy outcomes). The primary objective of confirmatory Part 2 (n=41) is to investigate the efficacy of risdiplam at the dose selected in Part 1. The primary efficacy endpoint is the proportion of infants sitting without support for 5 seconds after 12 months of treatment, as assessed by Item 22 of the Gross Motor Scale of the Bayley Scales of Infant and Toddler Development, third edition. Additional secondary endpoints will also be measured.

Results: Here we will report safety and novel efficacy data from FIREFISH Part 2 in infants treated with risdiplam for a minimum of 12 months at the Part 1 selected dose.

Conclusion: FIREFISH Part 2 will provide important data on the efficacy and safety of risdiplam in Type 1 SMA.

Disclosure: Study sponsored by F. Hoffmann-La Roche AG, Basel, Switzerland. Writing and editorial assistance was provided by MediTech Media, UK, in accordance with Good Publication Practice (GPP3) guidelines.

EPR1111

C9orf72 ALS human neural organoids for the development of new therapeutics and disease modeling.

G. Costamagna, I. Faravelli, F. Biella, M. Taiana, M. Rizzuti, M. Nizzardo, G. Comi, N. Bresolin, S. Corti
Department of Pathophysiology and Transplantation IRCCS Foundation Ca' Granda Ospedale Maggiore Policlinico, University of Milan, Milan, Italy

Background and aims: Amyotrophic lateral sclerosis (ALS) is a devastating neurodegenerative disease. C9orf72 repeat expansion is the most frequent genetic cause of ALS (C9ALS) in Europe and North America. Partially owing to an incomplete understanding of disease etiopathogenesis, disease-modifying therapies in C9ALS still lack. A better insight into C9ALS pathomechanisms in reliable models is fundamental for developing new therapeutics. Here, we aim to model C9ALS pathology in 3D human neural organoids.

Methods: We differentiated iPSCs from C9ALS patients and healthy controls' fibroblasts using a free-floating 3D-culture method. We generated early cerebral-like organoids (COs) using standard methods and ventral spinal cord-like organoids (vSCOs) with a modified protocol inducing neural caudalization and ventralization. Then, we treated C9ALS COs and vSCOs with morpholino antisense oligonucleotides (MO) against c9orf72 repeat expansion. Finally, we evaluated the differentiation of organoids at different time points with immunohistochemical and qPCR analysis.

Results: We obtained control and C9ALS COs and vSCOs organoids displaying different co-existing neuronal subpopulations. COs exhibited progenitor (SOX2), forebrain (PAX6) and immature post-mitotic neuronal markers (TUJ1); vSCOs expressed SOX2, TUJ1, ventro/caudal marker (HOXB4) and motor neuron marker (ISL1). C9ALS organoids dissociated into single cells showed pBRCA1 and γ H2AX foci, markers of DNA damage associated with c9orf72 expansion. Preliminary results on gene expression analysis using qPCR reported differential expression of genes involved in DNA damage response (GADD45A, CDKN1A) in MO treated C9ALS organoids.

Conclusion: Neural organoids represent an innovative in vitro system and a valuable platform for modelling aspects of C9ALS pathology, studying C9ALS pathomechanisms and potentially developing new treatments in vitro.

Disclosure: Nothing to disclose

EPR1112

Human Organoids to study and treat Spinal Muscular Atrophy

I. Faravelli¹, P. Rinchetti¹, S. Mancinelli², L. Mapelli³, G. Forotti⁴, M. Rizzuti⁵, C. Cordiglieri⁶, H. Moulton⁷, N. Bresolin⁸, G. Comi¹, E. D'angelo³, S. Lodato⁹, M. Nizzardo⁴, S. Corti¹⁰

¹Department of Pathophysiology and Transplantation, University of Milan, Milan, Italy, ²Department of Biomedical Sciences, IRCCS Humanitas Clinical and Research Center, Rozzano, Italy, ³Department of Brain and Behavioral Sciences, University of Pavia, Pavia, Italy, ⁴IRCCS Foundation Ca' Granda Ospedale Maggiore Policlinico, Milan, Italy, ⁵Department of Pathophysiology and Transplantation, University of Milan, Milan, Italy, ⁶Imaging Department, Istituto Nazionale di Genetica Molecolare, Milan, Italy, ⁷Biomedical Sciences, Oregon State University, Corvallis, USA, ⁸Neurology, University of Milan, Milan, Italy, ⁹Department of Biomedical Sciences, IRCCS Humanitas Clinical and Research Center, Rozzano, Italy, ¹⁰Neurological Sciences, University of Milan, Milan, Italy

Background and aims: Spinal muscular atrophy (SMA) is a neuromuscular disease and the 1st cause of genetic death in infancy. SMA results from mutations in the Survival Motor Neuron (SMN) gene encoding for SMN, a ubiquitously expressed protein with a fundamental role in RNA processing. The optimization of available therapies and the development of complementary therapeutic approaches to SMA requires a deeper understanding of SMN pathophysiology in reliable models. We herein present a new model of SMA pathology in 3D human neural organoids.

Methods: We generated induced pluripotent stem cells (iPSCs) from fibroblasts of SMA patients and healthy controls and developed cerebral organoids, exploiting an already established protocol. Using a novel modified differentiation method based on small molecules to promote caudalization and ventralization, we also derived ventral spinal cord-like organoids. We performed morphological and molecular analyses and single-cell RNAseq to evaluate the organoid differentiation state. Electrophysiological studies were also undertaken to study circuit function and activity. Ventral spinal cord-like organoids were also treated with a novel antisense oligonucleotides able to restore SMN protein levels through SMN2 splicing correction.

Results: SMA organoids exhibited a significant alteration in their neurofilament elongation and electrophysiological activity compared to those derived from healthy controls. Treatment of SMA ventral spinal cord-like organoids with a second-generation optimized anti-sense oligonucleotide rescued SMN levels and main pathological features.

Conclusion: Our data support the use of neural organoids as an innovative in vitro platform to investigate pathogenic mechanisms and test potential therapeutic strategies.

Disclosure: Nothing to disclose

EPR1113

Altered excitability in upper and lower motor neurons in Amyotrophic Lateral Sclerosis

P. Kokotis¹, R. Carr², M. Schmelz², M. Rentzos¹, E. Bakola¹, E. Koropouli¹, T. Zambelis¹, N. Karandreas¹
¹Neurology, Eginition University Hospital, Athens, Greece, ²Department of Experimental Pain Research, University of Heidelberg, Mannheim, Germany

Background and aims: Corticomotoneuronal hyperexcitability via an anterograde trans-synaptic glutaminergic process has been proposed as an underlying mechanism for the processes underlying motor neuron degeneration in ALS. The initiation site of degeneration is still controversial. In this study we aim to explore the temporal pattern of excitability of upper and lower motor neurons over the disease course.

Methods: We examined 62 patients and 25 controls subjects. Multiple excitability measurements of median nerve were recorded from the abductor pollicis brevis muscle and upper motor neuron excitability was tested using transcranial magnetic stimulation of increasing intensity and recording of the same muscle.

Results: Our findings reveal that in ALS patients there is increased refractoriness, higher threshold changes in depolarizing threshold electrotonus at 90-100ms and higher superexcitability along with lower subexcitability of the recovery cycle. Regarding the peripheral excitability, our data demonstrate significant changes in the threshold of depolarizing electrotonus at 90-100ms at early stages of ALS. Furthermore, with respect to the cortical excitability, there is a positive correlation between the stage of ALS and the slope of the area of the motor evoked potentials (MEPs); the earlier the stage the greater the increase in MEPs. Finally, the excitability of lower and upper motor neurons was concurrently increased in our patients.

Conclusion: Central and peripheral excitabilities are increased in ALS and their measures can serve as prognostic factors for the disease.

Disclosure: Nothing to disclose

EPR1114

Clinical Development of SRK-015, a Fully Human Anti-proMyostatin Monoclonal Antibody, for the Treatment of Later Onset Spinal Muscular Atrophy

G. Nomikos, A. Place

Scholar Rock, Cambridge, USA

Background and aims: SRK-015 is a fully human anti-proMyostatin monoclonal antibody (mAb) that selectively binds to pro-/latent myostatin with high affinity, inhibiting its activation. SRK-015 is being developed for the treatment of spinal muscular atrophy (SMA) with the aim of offering clinically meaningful improvements in motor function.

Methods: A Phase 1, adult healthy volunteer study demonstrated a favorable safety profile at all doses tested; a well-behaved pharmacokinetic profile and robust and durable target engagement. The ongoing Phase 2 study evaluates the safety and efficacy of SRK-015 dosed IV every four weeks over 52 weeks. 3 distinct and parallel cohorts were enrolled. Cohort 1 enrolled ambulatory Type 3 SMA patients treated with 20mg/kg of SRK-015 as monotherapy, or in conjunction with an approved SMN up-regulator therapy. Cohort 2 enrolled Type 2 or non-ambulatory Type 3 SMA patients, who were already treated with an approved SMN up-regulator therapy. Patients were treated with 20mg/kg of SRK-015. Cohort 3 enrolled Type 2 SMA patients, who initiated treatment with an approved SMN up-regulator therapy before turning 5; patients were randomized 1:1 to either 2mg/kg or 20mg/kg of SRK-015.

Results: The primary objectives of this study are safety and efficacy (including Revised Hammersmith Scale, Hammersmith Functional Motor Scale Expanded and other motor function outcome measures).

Conclusion: N/A

Disclosure: All authors of this abstract are employees of Scholar Rock, a biopharmaceutical company. At the time of this abstract submission, this data has not been presented at, nor accepted to, any other medical congress.

EPR1115

Facial Onset Sensory and Motor Neuronopathy (FOSMN): Aetiology, Pathophysiology and Natural History

H. Oliveira¹, M. Silsby², S. Jaiser³, T. Polvikoski⁴, A. Joshi⁵, M. Lai⁶, S. Vucic², M.R. Baker⁷, T.L. Williams⁸

¹Neurology, Newcastle University, Newcastle, United Kingdom, ²Neurology, The University of Australia, Sydney, Australia, ³Neurophysiology, Royal Victoria Infirmary, Newcastle, United Kingdom, ⁴Pathology, Newcastle University and Royal Victoria Infirmary, Newcastle, United Kingdom, ⁵Pathology, Royal Victoria Infirmary, Newcastle, United Kingdom, ⁶Neurophysiology, Royal Victoria Infirmary, Newcastle Upon Tyne, United Kingdom, ⁷Neurophysiology, Newcastle University and Royal Victoria Infirmary, Newcastle, United Kingdom, ⁸Neurology, Royal Victoria Infirmary, Newcastle, United Kingdom

Background and aims: FOSMN Syndrome remains poorly characterised as only small number of cases have been described in the literature. Herein, we describe 6 novel cases and perform the 1st systematic review of the literature (SRL), thus elucidating the aetiology, pathophysiology and natural history of FOSMN.

Methods: Clinical examination, SRL, genetic testing, neuropathology.

Results: A total of 73 patients were identified. The mean age of onset was 53 for men and 56 for women. Facial sensory disturbance was the commonest sensory feature (93%), followed by an abnormal corneal reflex (56%) (Figure 1). The commonest motor features were facial weakness (71%), upper limb weakness (69%), dysphagia (67%) and dysarthria (54%) (Figure 2). Median survival was 6 years and bronchopneumonia was the most common cause of death (30%). There was no clear evidence of benefit from immunosuppressive therapy.

TDP43 inclusions were present in 2 of our patients (figure 3) and in 66% of patients in total. Genetic testing revealed missense variants in genes associated with motor neurone disease (MND) in 21% of cases.

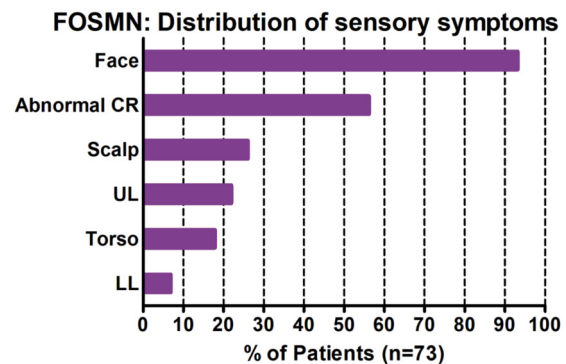

Figure 1: Sensory features of FOSMN. Facial sensory disturbance (93%) was present in almost all patients and an abnormal corneal reflex (CR) was also frequently present (56%).

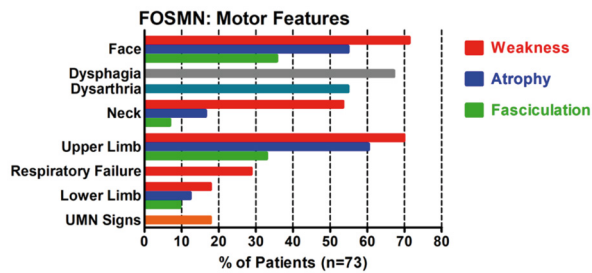

Figure 2: Motor features of FOSMN. Facial weakness (71%), upper limb (UL) weakness (69%), dysphagia (67%) and dysarthria (54%) were present in most patients.

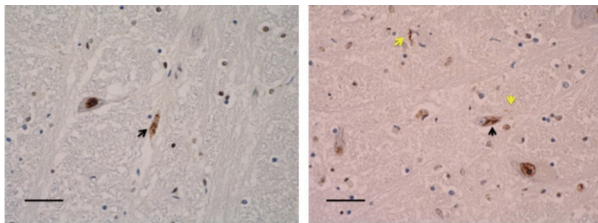

Figure 3: Representative images of histopathological examination of the medulla demonstrating TDP43 mislocalisation and aggregation in two patients diagnosed with FOSMN. The presence of neuronal intracytoplasmic inclusions (black arrows) and dystrophic neurites (yellow arrows) recapitulates the neuropathological hallmarks of MND. [Scale bar 50µm]

Conclusion: FOSMN starts with facial sensory disturbance. Deficits then spread rostro-caudally, in a similar pattern to bulbar-onset MND, albeit with longer median survival. Moreover, the clinical features, together with the emerging neuropathological and genetic data strongly support the suggestion that FOSMN is a rare variant of MND.

Thus, patients with FOSMN should receive multidisciplinary care in the MND clinic and raise the scientific question of why, in these cases, sensory neurones are susceptible to neurodegeneration, which may provide further insight into the pathophysiology of MND.

Disclosure: I am appointed by the NIHR as an academic clinical lecturer in Neurology which has enabled me to take the lead in this research work.

EPR1116

A Phase 2 Study to Evaluate the Efficacy and Safety of SRK-015 in Patients with Later-Onset Spinal Muscular Atrophy (TOPAZ): An Introduction

A. Place, D. Barrett, S. Cote, R. Iarrobino, G. Nomikos, C. Yung

Scholar Rock, Cambridge, USA

Background and aims: SRK-015 is a fully human anti-proMyostatin monoclonal antibody (mAb) that is being developed and investigated for the treatment of later-onset SMA. This Phase 2 study evaluates the safety and efficacy of SRK-015 on motor function in SMA patient Types 2 and 3.

Methods: All patients received SRK-015 every 4 weeks via intravenous infusion for 52 weeks. Patients in Cohorts 1 (N=20) and 2 (N=15) were treated with 20 mg/kg SRK-015 and patients in Cohort 3 (N=20) were randomized 1:1 in a double-blind manner to receive either 2 mg/kg or 20 mg/kg of SRK-015. Cohort 1 enrolled ambulatory Type 3 patients, aged 5-21, some of whom started an approved SMN up-regulator after the age of 5, and others who were not receiving an SMN up-regulator. Cohort 2 enrolled Type 2 and non-ambulatory Type 3 patients, aged 5-21, already receiving an approved SMN up-regulator that was started after the patient turned 5. Cohort 3 enrolled SMA Type 2 patients ages 2 and older, already receiving an approved SMN up-regulator that was started before the patient turned 5.

Results: Efficacy assessments include the Revised Hammersmith Scale (Cohort 1), Hammersmith Functional Scale Expanded (Cohorts 2 and 3) and other motor function outcome measures. Safety will be assessed throughout the trial. Pharmacokinetics, pharmacodynamics and immunogenicity of SRK-015 will also be evaluated. Demographic, baseline characteristics and preliminary PK/PD data will be presented.

Conclusion: N/A

Disclosure: All the authors of this abstract are employees of Scholar Rock, a biopharmaceutical company. At the time of this submission, this data has not been presented, nor accepted, at any other medical congresses.

EPR1117

Protease Activated Receptor 1 Pathway: A Therapeutic Target in the SOD1 Mouse Model of Amyotrophic Lateral Sclerosis

E. Shavit-Stein¹, I. Abu Rahal¹, D. Bushi¹, O. Gera¹, R. Sharon¹, S. Gofrit¹, L. Pollak¹, K. Mindel¹, N. Maggio¹, J. Chapman², A. Dori¹

¹Neurology, Sheba Medical Center, Ramat Gan, Israel, ²Tel Hashomer, Israel

Background and aims: Motor neuron degeneration in amyotrophic lateral sclerosis (ALS) involves interactions with glial cells, which can exert either supportive or toxic effects. Protease activated receptor 1 (PAR1) is activated by thrombin and is related to various central and peripheral nervous system pathologies. PAR1 is present on perisynaptic astrocytes, adjacent to large pyramidal motor neurons. PAR1 location and harmful effects suggests its involvement in ALS and therefore was studied in the superoxide dismutase 1 (SOD1) model.

Methods: Brain thrombin activity in SOD1 mice was measured using a fluorometric assay, and PAR1 levels by western blot. PAR1 was localized using immunohistochemistry staining. Treatment targeted PAR1 pathway on 3 levels; thrombin inhibitor TLCK (N-Tosyl-Lys-chloromethylketone), PAR1 antagonist SCH-79797 and the Ras intracellular inhibitor FTS (S-trans-trans-farnesylthiosalicylic acid). Mice were weighed weekly and assessed for motor function and survival.

Results: SOD1 Brain thrombin activity was increased ($p < 0.001$) particularly in the posterior frontal lobe ($p = 0.027$) and hindbrain ($p < 0.01$). PAR1 levels were decreased ($p < 0.001$). Immunohistochemistry showed decreased staining in the cerebellum and cortex. SOD1 mice lost weight (≥ 17 weeks, $p = 0.047$), and showed shorter rotarod time (≥ 14 weeks, $p < 0.01$). Treatment with FTS 40mg/kg significantly improved rotarod scores ($p < 0.001$). SOD1 mice survival improved with all treatments ($p < 0.01$ for all treatments). PAR1 antagonism was the most efficient, with a median survival improvement of 10 days ($p < 0.0001$).

Conclusion: Our results support PAR1 pathway involvement in ALS pathogenesis. Intervention in the PAR1 pathway improves SOD1 mice survival and motor function, marking it a novel therapeutic target for ALS.

Disclosure: JC has a registered patent "Non-malignant disease treatment with Ras antagonist" in which FTS is included.

EPR1118

Structural MRI outcomes and predictors of disease progression in amyotrophic lateral sclerosis

E.G. Spinelli¹, N. Riva², P.M. Rancoita³, P. Schito⁴, A. Doretto⁵, B. Poletti⁵, C. Di Serio³, V. Silani⁵, M. Filippi¹, F. Agosta¹

¹Neuroimaging Research Unit, Institute of Experimental Neurology, Division of Neuroscience, IRCCS San Raffaele Scientific Institute, Milan, Italy, ²Neurorehabilitation Unit, IRCCS San Raffaele Scientific Institute, Milan, Italy, ³University Centre for Statistics in the Biomedical Sciences, Vita-Salute San Raffaele University, Milan, Italy, ⁴Neurology Unit, IRCCS San Raffaele Scientific Institute, Milan, Italy, ⁵Department of Neurology and Laboratory of Neuroscience, IRCCS Istituto Auxologico Italiano, Milan, Italy

Background and aims: This study aims to explore the progression of clinical and structural brain changes in patients with ALS, and to assess magnetic resonance imaging (MRI) measures of brain damage as predictors of subsequent functional decline.

Methods: 50 ALS patients underwent clinical evaluations and 3T MRI scans at regular intervals for a maximum of 2 years (total MRI scans=164). MRI measures of cortical thickness, as well as diffusion tensor (DT) metrics of microstructural damage along white matter (WM) tracts were obtained. Voxel-wise regression models and longitudinal mixed-effects models were used to test the relationship between clinical decline and baseline and longitudinal MRI features.

Results: The rate of decline of the ALS Functional Rating Scale revised (ALSFRS-r) was significantly associated with the rate of fractional anisotropy (FA) decrease in the body of the corpus callosum (CC). Damage to the corticospinal tract (CST) and CC-body had a faster progression in patients with higher baseline ALSFRS-r scores and greater CC-body damage at baseline. Lower FA of the cerebral peduncle was associated with faster subsequent clinical progression.

Conclusion: In this longitudinal study, we identified a significant association between measures of WM damage of the motor tracts and functional decline in ALS patients. Our data suggest that a multiparametric approach including DT MRI measures of brain damage would provide an optimal method for an accurate stratification of ALS patients into prognostic classes.

Disclosure: Supported by: Italian Ministry of Health (RF-2010-2313220; RF-2011-02351193).

EPR1119

Functional impairment and survival prediction in Amyotrophic Lateral Sclerosis patients: a probabilistic model of disease progression

R. Vasta¹, A. Zandonà², S. Daberduku², E. Tavazzi², B. Nefussy³, C. Lunetta⁴, G. Mora⁵, J. Mandrioli⁶, E. Grisan², C. Tarlarini⁴, A. Calvo¹, C. Moglia¹, M. Gotkine⁷, V.E. Drory⁸, A. Chiò⁹, B. Di Camillo²

¹Department of Neuroscience, University of Turin, Turin, Italy, ²Department of Information Engineering, University of Padova, Padova, Padua, Italy, ³Neurology, Tel-Aviv Medical Center, Tel-Aviv, Israel, ⁴Fondazione Serena Onlus, Milano, Centro Clinico Nemo Milano, Milan, Italy, ⁵Milano, Istituti Clinici Scientifici Maugeri IRCCS, Milan, Italy, ⁶Univ. of Modena, Modena, Italy, ⁷Jerusalem, Israel, Hadassah University Hospital Medical Center, Jerusalem, Israel, ⁸Tel Aviv, Israel, ⁹Turin, Italy

Background and aims: We aimed to develop a probabilistic model of progression in ALS.

Methods: Data from 6 International referral ALS centres were used (overall database, OD). A database including only data from Italian registries was created too (Italian database, ID).

ALSFRS-R scores from clinical evaluations were converted into MITOS score. Progression to positivity of each MITOS domain and to survival was considered.

Dynamic Bayesian Networks were used to predict progression. Each database was divided into a training dataset for developing the model and a test dataset to validate it.

The concordance of the real and the simulated progression was quantified as the difference between the percentages of patients having experienced each event in the 2 models at predefined intervals. Additionally, area under ROC curve (AUC) was computed at the same intervals.

Results: OD included 4,026 ALS patients and 24,960 visits. ID included 2,149 ALS patients and 15,767 visits.

The simulated model showed a median difference in percentage of 2.19 (IQ 1.78-3.49) and 1.4 (IQ 0.26-2.16) for the OD and the ID respectively; prediction of survival showed a median difference of 1.86 (IQ 0.59-2.9) and 2.64 (IQ 0.81-3.12) respectively. The AUC for simulated MITOS impairment and survival was in median 0.83 (IQ 0.81-0.84) and 0.85 (IQ 0.83-0.88) for OD and ID respectively.

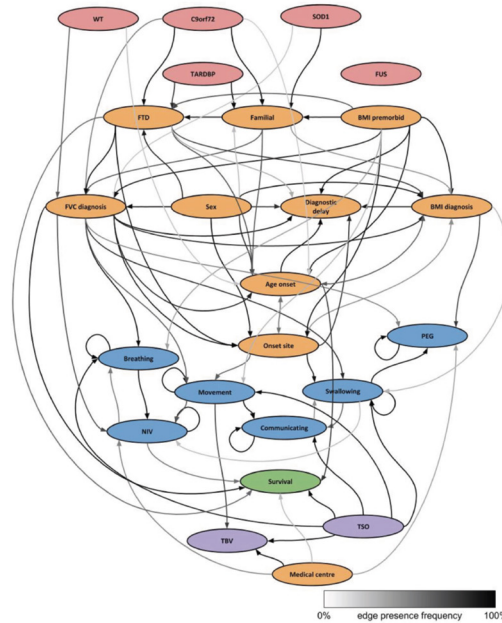

Fig1. Directed graph obtained on training set, representing the conditional dependencies among variables in ID. TBV=time between consecutive visits; TSO=time since ALS onset; Breat., Swallow., Commun., Mov.:MITOS domains. The node colour encodes the variable type: static=orange, genetic=pink, dynamic=blue, time-encoding=purple and survival=green.

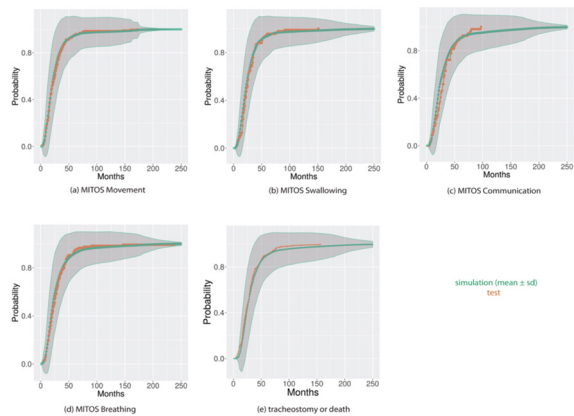

Figure 2. Cumulative probability of impairment in the four MITOS domains and of tracheostomy/death over time in the ID training dataset (orange line) and in the simulated population (green line: mean values over population; shaded region: standard deviation), based on probabilities modeled by the Dynamic Bayesian Networks.

Conclusion: We developed a model able to predict the loss of independence in four main motor domains and survival in ALS with a high accuracy.

Disclosure: This work was funded by the bilateral Italian-Israel project CompALS (Computational analysis of the clinical manifestations and predictive modeling of ALS), supported by the Italian Ministry of Foreign Affairs and International Cooperation and the Ministry of Science, Technology and Space of the State of Israel. The model is currently under patent evaluation.

EPR1120

Plateaus in Amyotrophic Lateral Sclerosis progression: results from a population-based cohort.

R. Vasta¹, F. D'ovidio¹, A. Canosa¹, U. Manera¹, M.C. Torrieri¹, M. Grassano¹, F. De Marchi², L. Mazzini³, C. Moglia¹, A. Calvo¹, A. Chio¹

¹Department of Neuroscience, University of Turin, Turin, Italy, ²Neurology, University of Eastern Piedmont, Novara, Novara, Italy, ³Department of Neurology, University Hospital "Maggiore della Carità", Novara, Italy

Background and aims: To assess the frequency of plateaus in Amyotrophic Lateral Sclerosis (ALS) progression using a large population-based cohort.

Methods: Data from the Piedmont and Aosta Valley ALS register were used. Patients who were diagnosed between 2007 and 2014 were considered. Follow-up period was extended until December 31st 2018. Visits subsequent tracheostomy were not considered. A plateau was defined as a stable ALSFRSr revised score lasting at least 6, 12 or 18 months.

Results: Out of 1214 patients, 200 (16.5%), 93 (7.7%) and 52 (4.3%) showed at least one plateau lasting a minimum of 6, 12 and 18 months, respectively. Plateaus occurred mostly at high ALSFRSr scores and were more frequent during the initial phases of the disease course (fig. 1. e 2). Spinal onset (OR 1.83, 95% CI 1.16–2.95, p-value=0.01) and predominant upper motor neuron phenotype (OR 2.18, 95% CI 1.36–3.48, p-value=0.001) conferred a higher risk for the subsequent appearance of plateaus; conversely, older age at diagnosis (OR 0.25, 95% CI 0.1–0.54, p-value=0.002 for >75 age class) reduced the risk.

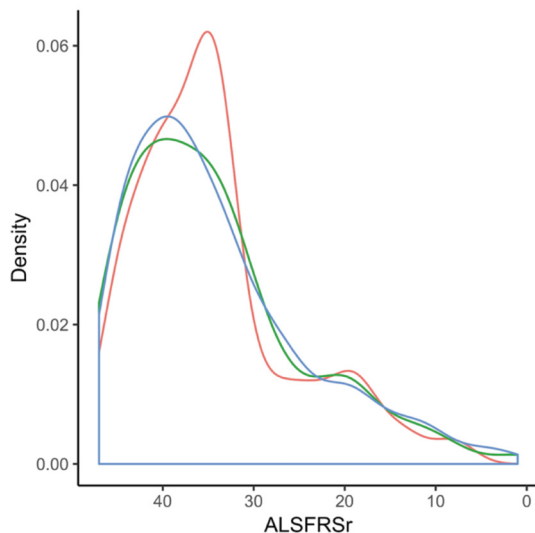

Figure 1. Kernel density estimation (KDE) of ALSFRSr total scores at which occurred plateaus lasting at least 6 months (blue), 12 months (green) and 18 months (red). KDE is a non-parametric estimation of a probability density function of a random variable allowing a smoothing of density curves.

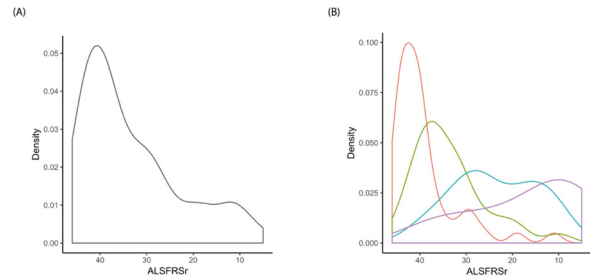

Figure 2. Kernel density estimation (KDE) of ALSFRSr total scores at which occurred 6-months plateaus of patients deceased during the follow-up: A) globally and B) divided by survival quarters (1st quarter=red; 2nd quarter=green; 3rd quarter=blue; 4th quarter=violet).

Conclusion: Plateaus in ALS progression lasting at least 6 months appear in about one out of 6 patients and could last even 12, 18 months or more in a smaller subgroup of patients. Plateaus occurrence should not necessarily suggest the neurologist to reconsider the ALS diagnosis and should be considered for future clinical trials design.

Disclosure: Nothing to disclose

Movement disorders 1

EPR1121

Glucocerebrosidase activity and atypical parkinsonism: a multi-centre exploratory study

R. Álvarez Velasco¹, P. Giraldo², P. Irun³,
L. Vela Desojo⁴, L. López Manzanares⁵,
J.M. Arbelo Gonzalez⁶, M. Eimil⁷, A. Rojo Sebastian⁸,
M. Mata Santullano⁹, I. Martínez Torres¹⁰,
J. García Caldentey¹¹, M. Gomez Gutierrez¹²,
C. Estévez Fraga¹, J.L. Lopez Sendon¹³,
G. García Ribas¹³, J.C. Martínez Castrillo¹⁴,
A. Alonso Cánovas¹

¹Neurology, Hospital Ramón y Cajal, Madrid, Spain,

²Traslational Research Unit, Miguel Servet University Hospital-IACS., Saragossa, Spain, ³Unidad de Lípidos.

Departamento de Bioquímica, Biología Molecular y Celular. Facultad de Ciencias, Universidad de Zaragoza, Saragossa, Spain,

⁴Hospital Universitario Fundación Alcorcón, Alcorcón-Madrid, Spain, ⁵Neurology, Hospital La Princesa, Madrid, Spain, ⁶Unidad de Parkinson y Trastornos del

Movimiento. Servicio de Neurología, Hospital Universitario San Roque, Las Palmas de Gran Canaria, Spain, ⁷Torrejón de Ardoz, Spain, ⁸Neurology, Hospital Universitario Príncipe de Asturias, Alcalá de Henares, Spain, ⁹Hospital Infanta Sofía, Madrid, Spain, ¹⁰Hospital Universitario La Fe, Valencia, Spain, ¹¹Neurology, Centro Neurológico Oms ⁴²,

Palma de Mallorca, Spain, ¹²Neurology, Hospital San Pedro de Alcántara, Cáceres, Spain, ¹³Neurology, Hospital Ramon y Cajal, Madrid, Spain, ¹⁴Hospital Universitario Ramón y Cajal, Madrid, Spain

Background and aims: Glucocerebrosidase (GBA) mutations cause autosomal recessive Gaucher's disease (GD) due to enzyme deficiency. GBA heterozygous mutations are common in Parkinson's disease (PD), in Spain accounting for 9.8% of PD patients. GD1 (adult type) has only systemic features, but PD and exceptionally atypical parkinsonism (AP) resembling corticobasal syndrome (CBS) have been reported, with mild or absent systemic features of GD. We aimed to determine the frequency of GBA deficiency (subclinical GD1) in patients with AP with features of tauopathy (progressive supranuclear palsy-PSP and CBS).

Methods: Cross-sectional multicentre study of PSP and CBS patients, including demographic and clinical variables, beta-glucosidase and chitotriosidase serum activity in dried blood spots, and complete GBA gene sequencing whenever activity was low or dubious.

Results: 60 patients (55% male, mean age 74 years, 60-80) diagnosed with PSP (46), CBS (10) or mixed PSP/CBS (4) were included. Family history was positive for parkinsonism (PD/AP) in 13 (22%). Beta-glucosidase and chitotriosidase serum activity were normal in 53 but dubious in 7. 13 cases, including these 7, underwent complete GBA gene sequencing, which showed heterozygous mutations in 3 cases (23%) (c.1226A>G N370S; c.1093G>A and c.-15A>G); 2 had CBS and 1 mixed PSP/CBD phenotype.

Conclusion: Our study does not support an association among tauopathies and low GBA enzyme activity. However, GBA mutations were found in a higher than expected frequency, which could result from selection bias but warrants further research for clarification.

Disclosure: Shire (now Takeda Pharmaceutical Company) supported dried blood spot enzymatic tests and gene sequencing.

EPR1122

Impulse Control Behaviours in People with Parkinson's Disease: Findings from the Parkinson's Disease Real-World Impact Assessment (PRISM) Study

A. Antonini¹, E. Tolosa², J.J. Ferreira³, A. Lees⁴, T. Foltynie⁴, G. Ebersbach⁵, O. Rascol⁶, J.-F. Rocha⁷, D. Magalhães⁷, P. Soares-Da-Silva⁸

¹Department of Neurosciences, University of Padova, Padua, Italy, ²Parkinson Disease and Movement Disorder Unit, Hospital Clinic, University of Barcelona, Barcelona, Spain, ³Laboratory of Clinical Pharmacology and Therapeutics, Faculty of Medicine, University of Lisbon, Lisbon, Portugal, ⁴Department of Clinical and Movement Neurosciences, National Hospital for Neurology and Neurosurgery, London, United Kingdom, ⁵Movement Disorders Clinic, Beelitz Hospital, Beelitz, Germany, ⁶Department of Neurosciences and Clinical Pharmacology, University of Toulouse, Toulouse, France, ⁷Global Parkinson's Disease Department, BIAL - Portela & Ca S.A., Coronado, Portugal, ⁸Research and Development Department, BIAL - Portela & Ca S.A., Coronado, Portugal

Background and aims: Impulse control disorders are part of behavioural disturbances in people with Parkinson's disease (PwP) and may result in serious financial and psychosocial consequences [1,2]. Impulse control behaviour (ICB) was assessed in PRISM, a European survey of PwP and their care-partners.

Methods: PRISM was a descriptive, exploratory, observational study with cross-sectional design fielded through an online survey developed in collaboration with The Cure Parkinson's Trust (UK-based advocacy group) and an international scientific committee. Collecting data through online channels may limit results interpretation. ICBs were collected based on yes/no answers to the question "are any of the behaviours listed an issue for you, or do others think that you have an issue?". Behaviours included pathological gambling, hypersexuality, compulsive shopping, binge-eating, overuse of antiparkinsonian medications and hobbyism. Data were assessed in relation to patient characteristics, including dopamine agonist (DA) use and presence of comorbid depression/anxiety.

Results: Between April-July 2019, data were collected from 861PwP from 6 European countries. Overall, approximately 45% of PwP reported at least one ICB (Figure 1). All ICBs were more frequently reported in PwP currently taking DA versus those who had never taken DA (Figure 1). PwP diagnosed with comorbid depression (22%) or anxiety (16%) were more likely than other PwP to report ICBs relating to eating, shopping, overuse of antiparkinsonian medications and hobbyism (Figure 2).

Figure 1. Impulse control behaviours reported by total PwP and according to DA use. DA, dopamine agonist; PD meds, overuse of Parkinson's disease medications; PwP, people with Parkinson's disease. n/N, affected subjects/total number of replies

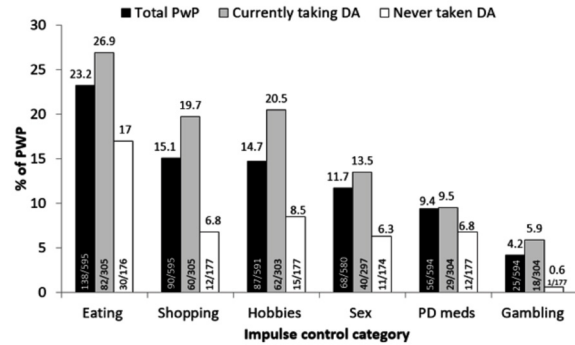

Figure 1

Figure 2. Impulse control behaviours reported by PwP, according to diagnosis of comorbid depression or anxiety. PD meds, overuse of Parkinson's disease medications; PwP, people with Parkinson's disease. n/N, affected subjects/total number of replies

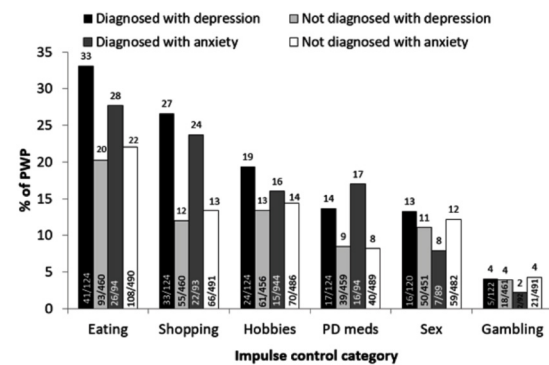

Figure 2

Conclusion: PRISM highlights relevance and range of ICBs in PwP and reinforces its association with DA use, mood and anxiety.

1. Gatto EM, Aldinio V. Front Neurol.2019;10:351.
2. Rodríguez-Violante M, Antonini A. Front Neurol. 2019;10:972.

Disclosure: Study supported by Bial - Portela & C^a, S.A.

EPR1123

Brain connectivity and music in Parkinson's disease

F. Arienti¹, E. Maggioni², F. Mameli³, S. Minella³,
L. Borellini³, M. Nigro³, F. Cogiamanian³, S. Barbieri³,
G. Ardolino³

¹Fondazione IRCCS Ca' Granda, Milan, Italy,

²Neurosciences and mental health, IRCCS Ca' Granda
Ospedale Maggiore Policlinico, Milan, Italy,

³Neurophysiology, Fondazione Ca' Granda Ospedale
Maggiore Policlinico, Milan, Italy

Background and aims: The study of brain activity and functional connectivity is of increasing interest in neurodegenerative diseases, including Parkinson's disease (PD). In this study, PD patients and healthy controls (HC) were compared in terms of EEG spectral power and effective connectivity, both at rest and during exposure to music tracks.

Methods: We enrolled 14 non-demented PD patients and 12 healthy controls. EEG recordings were obtained during resting-state condition and while listening to music. Fast Fourier Transform (FFT) was used to calculate the relative power spectral density (PSD) in the theta and alpha bands. Directional interactions among EEG channels were examined through Granger Causality Analysis (GCA). FFT and GCA parameters were compared between patients and HC using Wilcoxon rank sum tests.

Results: Resting state PSD displayed diffuse higher theta power in PD, a pattern predictive of cognitive impairment development according to literature. Effectively, patients showed a sensitive decrease in Montreal cognitive assessment (MoCA) test scores after three years of follow-up. During music listening, patients exhibited no occipital theta enhancement as found in HC.

GCA showed that PD patients have much less theta and alpha information entering the right sensorimotor area; this pattern was maintained during both resting state and music. Music listening modulated differently brain connectivity in PD patients compared to HC, as result of altered neuronal synchronization.

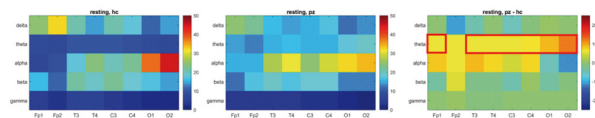

Resting state PSD as measured in healthy controls and patients

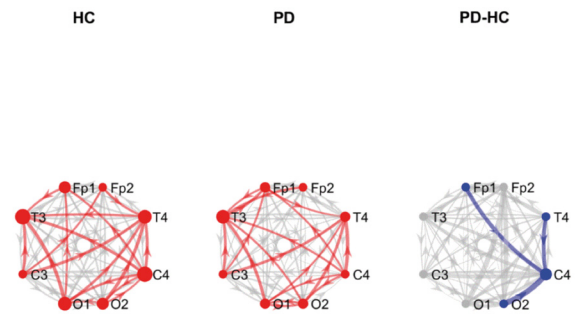

Topographical maps showing resting state GCA alpha band analysis in HC, patients and their statistically significant differences

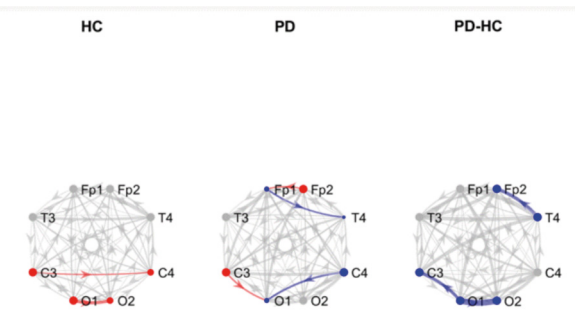

Topographical maps showing GCA alpha band percent change during Bach listening in HC, patients and their statistically significant differences

Conclusion: We highlighted brain activity and connectivity alterations in PD, predominantly involving the right sensorimotor cortex. This happened regardless of the mainly involved side and can be considered an expression of an increased risk of cognitive impairment development.

Disclosure: Nothing to disclose

EPR1124

Risk of Parkinson's disease in GBA mutation carriers: results from a Kin-cohort study in unselected Parkinson patients

R. Balestrino¹, S. Tunesi², S. Tesi³, L. Lopiano¹, A.L. Zecchinelli³, S. Goldwurm⁴

¹Neuroscience department "Rita Levi Montalcini", University of Turin, Turin, Italy., ²Unit of Medical Statistics and Epidemiology, Department of Translational Medicine, University of Eastern Piedmont, Novara, and CPO-Piedmont, Novara, Italy, ³Parkinson Institute, ASST "Pini-CTO", Milan, Italy, ⁴Parkinson Institute, ASST "Pini-CTO", Milan, Italy

Background and aims: Biallelic glucocerebrosidase (GBA) mutations cause Gaucher Disease (GD), while monoallelic heterozygous GBA mutations are considered the most important known genetic risk factor for Parkinson Disease (PD). The estimated risk of PD in heterozygous GBA mutations-carriers is highly variable, ranging between 10 and 30%. This risk is age specific and depends other genetic and non-genetic factors. The aim of this study was to assess the penetrance of GBA mutations in PD in a cohort of unselected PD patients using the Kin-cohort method.

Methods: 123 PD patients with GBA mutations were previously identified in a series of 2843 unrelated consecutive PD patients. Proband pedigrees were used in the Kin-cohort analysis. Mutations were divided in mild (p.N370S) and severe (p.L444P, p.G377S, splicing mutations).

Results: Data on family history was available for 63 out of 123 PD GBA mutations-carriers; 381 1st-degree relatives were analysed. The risk to develop PD was significantly different among relatives of GBA mutation-

Table. Percent penetrance estimates (95% CI) according to age.

First-degree relatives of:	N.	N.PD	60 y	70 y	80 y	p*
GBA-PD	381	20	10.0 % (5-17)	16.0 % (9-24)	19.4 % (12-28)	0.0069
GBA-PD Severe mutations	189	11	13.5 % (5-23)	18.2 % (9-29)	18.2 % (9-29)	0.014
GBA-PD Mild mutations	192	9	6.7 % (1-15)	13.6 % (3-27)	22.4 % (9-40)	0.011
Non-carriers	257	3	0.6 (0-22)	0.6 (0-21)	3.0 (0-7)	

N. = number of subjects (first degree relatives) considered in the Kin-cohort analysis.
N.PD = number of relatives affected by PD.
y= years of age.
* p value is calculated comparing the carrier group to the non-carrier.
The Relative Risk of each age-group was calculated comparing the carrier group to the non-carrier: for the whole GBA carrier at 60y was 17.26 (3.46-1.87-), at 70y was 27.40 (5.99-2.26), at 80y was 6.73 (2.17-inf); for the GBA-severe at 60y was 22.32 (4.53 -inf), at 70 y was 30.34 (6.82-inf), at 80y was 6.93 (2.36-inf); for the GBA-Mild at 60y was 11.28 (0.61-inf), at 70y was 22.45 (3.31-inf), at 80y was 6.93 (1.74-inf).

Table. Percent penetrance estimates (95% CI) according to age.

Conclusion: The estimated prevalence in this study is higher than the one estimated in GD cohorts and lower than the one estimated in familial PD cohorts. Our study was performed on unselected PD patients, avoiding the over or under estimation of penetrance that can occur in studies performed preferably on subjects with a positive family history of PD or GD. It is important that neurologists and genetic counsellors consider a possible ascertainment bias in their counselling.

Disclosure: Nothing to disclose

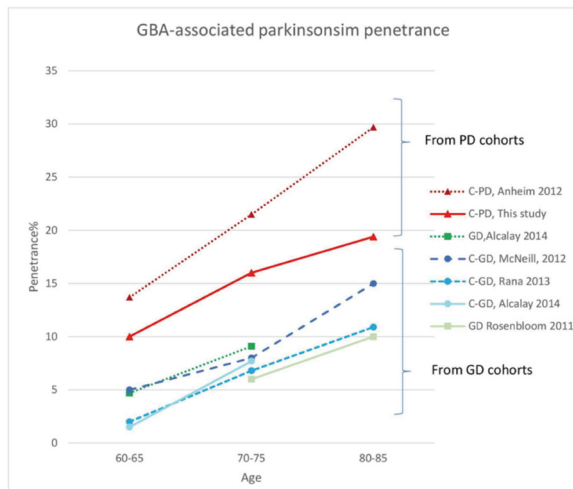

Figure: GBA-associated parkinsonism penetrance in previous studies.

GD= Gaucher Disease (symbol=■), C-GD= Carriers from GD cohorts (symbol=●), C-PD= Carriers from PD cohort (symbol=▲). Anheim et al., 2012: patients with GBA- PD from familial cases and their first-degree relatives(C-PD); Alcalay et al., 2014: GD patients and their parents (C-GD); McNeil et al., 2012: parents of GD patients (C-GD); Rana et al., 2013: GD patients and their parents (C-GD); Rosenbloom et al., 2011: GD patients

Figure: GBA-associated parkinsonism penetrance in previous studies.

EPR1125

Refractory tremor: is perampanel a potentially useful therapy?

Á. Beltrán Corbellini, F. Rodríguez Jorge, P. Parra Díaz, J.L. Chico García, I. Parés Moreno, J.C. Martínez Castrillo, A. Alonso Cánovas
Neurology, Hospital Universitario Ramón y Cajal, Madrid, Spain

Background and aims: Up to 40% of patients with essential (ET) or dystonic (DT) tremor are refractory. An increase in excitatory neurotransmitters has been hypothesized. Perampanel, an antiepileptic drug with AMPA receptor antagonist effect, may thus be potentially useful.

Methods: Retrospective analysis of the electronic records of patients with refractory ET or DT of our movement disorders unit along a 2-year period.

Results: 11 patients (7 women, mean age 72±8 years) who were prescribed perampanel due to insufficient tremor control were analysed. 4 were diagnosed with ET and 7 with DT, most of them with cephalic, vocal and upper limbs involvement, and mean previous follow-up of 7.6±4.0 years. Previous/concomitant treatments included propranolol (mean dose 70mg, range 20-120), primidone (250mg, 125-375), clonazepam (1mg, 0.5-2), and cervical botulinum toxin (4 cases). Mean perampanel dose was 4mg (2-8mg) qid, with a slow titration along several weeks, and follow-up 2.4±1.3 months. 4 patients improved, 2 were diagnosed with DT (Clinical Global Impression-Improvement, CGI-I, scale score of 1) and 2 with ET (CGI-I score 2). 5 patients (3 in monotherapy) reported mild-moderate adverse events (dizziness, sleep disturbances) at a mean dose of 3.2mg (range 2-4mg), and 1 patient was admitted due to ataxia and confusion at 8mg qid, overall leading to discontinuation in 5.

Conclusion: Perampanel may be effective in some patients with refractory tremor, albeit blinded randomized controlled trials are warranted to confirm this hypothesis. Poor tolerability may hinder dose escalation in a subset of patients.

Disclosure: Nothing to disclose

EPR1126

The association of early caudate involvement and REM sleep disorder behaviour could influence disease progression in Parkinson's Disease: A PPMI study.

L. Best¹, G. Roberts², V. Foster¹, G. Petrides³, K. Anderson⁴, N. Pavese¹

¹Neurosciences, University of Newcastle, Newcastle Upon Tyne, United Kingdom, ²Nuclear Medicine, University of Newcastle, Newcastle Upon Tyne, United Kingdom, ³Nuclear Medicine, Newcastle Upon Tyne NHS Foundation Trust, Newcastle Upon Tyne, United Kingdom, ⁴Neurology, Newcastle Upon Tyne NHS Foundation Trust, Newcastle Upon Tyne, United Kingdom

Background and aims: We investigated the occurrence of dopaminergic caudate dysfunction in patients with and without REM sleep behaviour disorder (RBD) in the early stages of Parkinson's Disease (PD) using 123I-FP-CIT SPECT, to determine whether this had an effect on clinical outcomes.

Methods: PD patients and healthy controls who had completed the RBD questionnaire were identified from the Parkinson's Progressive Markers Initiative database. Scores ≥5 were defined as 'RBD-positive' and those with a score <5 as 'RBD-negative'. Cohorts were then subdivided based on the presence of significant caudate dysfunction on 123I-FP-CIT binding from age-corrected z-scores, with abnormal scores <-2 SDs from normal mean. Statistical interrogation between groups was used to compare dopaminergic, clinical and cerebrospinal fluid (CSF) parameters.

Results: At baseline, 40.6% of our PD population had abnormal caudate function, with 37.5% of these being RBD-positive. There was no significant difference at baseline regarding caudate involvement and the presence of RBD (p=0.361), however the relationship was significant at 4-year follow-up (p=0.044), with a significant difference in the progression of caudate degeneration between cohorts (p=0.03).

At baseline, in the RBD-positive cohort patients with caudate involvement had greater UPDRS-scores (p=0.007) and lower alpha-synuclein CSF concentrations (p=0.017). There were no significant differences in the RBD-negative subjects relating to caudate involvement. At 36 months, there were significant differences regarding UPDRS score (p=0.02), cognitive scores (p=0.001) and alpha-synuclein sampling (p=0.048) comparing the abnormal caudate/RBD-positive group with the abnormal caudate/RBD-negative group.

Conclusion: Our findings suggest that co-existent early caudate dysfunction and presence of RBD is predictive of worse clinical outcomes in PD.

Disclosure: The authors are grateful to the Parkinson's Progressive Marker Initiative for the data provided in preparation of this manuscript. The PPMI is a public-private partnership funded by the Michael J Fox Foundation for Parkinson's Research and funding partners (listed at www.ppmi-info.org/fundingpartners).

EPR1127

Intrinsic brain functional connectivity predicts treatment-related motor complications in early Parkinson's disease patients

F.P. Bonifacio¹, R. De Micco¹, M. Siciliano¹, S. Satolli¹, F. Di Nardo¹, G. Caiazzo¹, F. Esposito², G. Tedeschi¹, A. Tessitore¹

¹Department of Advanced Medical and Surgical Sciences, University of Campania "L. Vanvitelli", Naples, Italy,

²Department of Medicine, Surgery and Dentistry, Scuola Medica Salernitana, University of Salerno, Baronissi (SA), Italy

Background and aims: Fluctuations in the symptoms of Parkinson's disease (PD) may be related to duration and dosage of levodopa, age at onset as well as pharmacokinetic and pharmacodynamics mechanisms. Using resting-state functional MRI, we investigated intrinsic brain networks connectivity at baseline in a cohort of drug-naïve PD patients which successively developed treatment-related motor complications (PD-Fluct) over a 4-years follow-up period compared with patients who did not (PD-no-Fluct)

Methods: Baseline 3Tesla MRI images of 88 drug-naïve PD patients and 20 matched healthy controls (HC) were analyzed. Single-subject and group-level independent component analysis was used to investigate functional connectivity differences within the major resting state networks. Additionally, a region-of-interest analysis was performed within the basal ganglia. After the baseline assessments, all patients started a dopaminergic replacement therapy and were followed for an observation period lasting a maximum of 4 years, with a clinical assessment every 6 months. Regression analyses were used to investigate baseline predictors of motor complications development.

Results: At baseline, an increased connectivity within the default mode and the frontoparietal networks as well as within the basal ganglia were detected in PD-Fluct patients compared with PD-no-Fluct. Functional connectivity changes at baseline showed to be an independent predictor of motor complications at 4-year follow-up.

Conclusion: Our findings demonstrated that sensorimotor and neurocognitive functional connectivity changes may characterize drug-naïve PD patients more prone to develop treatment-related complications. We hypothesize that these findings may reflect the presence of early dopaminergic pathways differences and might predict development of motor complications over time.

Disclosure: Nothing to disclose

EPR1128

Clonidine GH stimulation test to differentiate MSA from idiopathic late onset cerebellar ataxia: a prospective, controlled study.

C. Bonnard¹, T. Wirth¹, O. Gebus¹, S. Montaut², C. Tranchant², M. Anheim²

¹CHU Strasbourg, Strasbourg, France, ²STRASBOURG, France

Background and aims: Despite the consensus criteria for multiple system atrophy (MSA), the diagnosis of MSA of cerebellar type (MSA-C) is difficult in the early stage of the disease. There are several differential diagnoses including idiopathic late-onset cerebellar ataxias (ILOCA) and it is often necessary to wait for clinical worsening so that the criteria can be met. Our aim was to assess the efficacy of clonidine growth hormone test (CGH test) to distinguish MSA-C from ILOCA in the early stage of the disease.

Methods: Within our cohort of late-onset sporadic, progressive cerebellar ataxia, the group of patients meeting the criteria for MSA was compared to the ILOCA group. Clinical and paraclinical examination including CGH test were repeated during the prospective follow-up.

Results: 86 patients were recruited, including 42 patients in the MSA group and 44 ILOCA patients with a mean follow up of 33 months. At the inclusion visit, CHG test was pathological for 31% MSA of patients and 18.2% of ILOCA (p=0.35). During the follow-up, 52.4% of MSA-C had a pathological CGH test, while only 20.5% of ILOCA (p<0.01). CGH test had a sensitivity of 69.1% and a specificity of 68.2%, (p<0.001) for MSA-C patients; CGH test allows in ¾ of cases, if negative, to rule out a probable MSA-C (negative predictive value of 75%, p=0.0014).

Conclusion: This prospective, controlled study showed that CGH test could be helpful in clinical practice to differentiate MSA-C from ILOCA in the early stage of the disease.

Disclosure: Nothing to disclose

EPR1129

Pathophysiology of Parkinson's disease: Investigating the protein alpha-synuclein bound to ubiquitin, dopamine, proteasomal and lysosomal system dysfunction with theoretical nuclear physics methods

J.M. Brandet

Centro Universitário Filadélfia, Londrina, Brazil

Background and aims: Parkinson's disease (PD) results from the death of dopamine-producing neurons in the substantia nigra and is characterized by an abnormal accumulation of protein alpha-synuclein. This study aims to identify, investigate and analyze the protein alpha-synuclein bound to ubiquitin, dopamine, proteasomal and lysosomal system dysfunction with theoretical nuclear physics methods.

Methods: Structural properties of protein alpha-synuclein bound to ubiquitin and dopamine have been determined using both density-based and wave-function-based electronic structure methods in order to assess the ability of ab initio "force fields" to retain the properties described by experimental structures measured with crystallography or nuclear magnetic resonance. Using Molecular Dynamics (MD) and Monte-Carlo simulations, the proteasomal and lysosomal system dysfunction in pathophysiology of Parkinson's disease were analyzed. The computational simulations and analyzes of this scientific work were elaborated with the use of software: ACD/ChemSketch, Swiss-PdbViewer, ABCpred, BepiPred-2.0, ElliPro, DEseq, GOseq, FunRich, Cytoscape, BiNGO, PepSurf, AxonDeepSeg, AxonSeg, PyMol, ICM-Browser, LAMMPS, Gaussian, Visual Molecular Dynamics (VMD), Cell Illustrator, GENESIS, NEURON, NeuronStudio and ChemDraw.

Results: Protein alpha-synuclein bound to ubiquitin accumulates inside neurones and this accumulation impairs cell function. Local phi (ϕ) and psi (ψ) torsion angle fluctuations of the alpha-synuclein indicates that disturbances in protein synthesis and deformations in amphipathic N-terminal, central hydrophobic and a highly acidic and proline-rich region of this protein can interfere in the biosynthetic and metabolic pathway in dopamine. Dopamine degradation and synaptic problems can be triggered by alpha-synuclein conformation disorders.

Conclusion: Understanding the pathological mechanisms should help developing new therapeutic tools to treat this disease and other movement disorders.

Disclosure: Nothing to disclose

EPR1130

N-Acetyl-L-Leucine for Niemann-Pick Disease, Type C, GM2-Gangliosidosis and Ataxia telangiectasia: Three multinational, multicenter, open-label, rater-blinded phase II clinical trials

T. Bremova-Ertl¹, M. Patterson², T. Fields³, M. Factor³, R. Kay⁴, M.L. Strupp⁵¹Berne, Switzerland, ²Department of Neurology, Mayo Clinic, Rochester, Rochester, USA, ³IntraBio Ltd, Begbroke Science Park, Begbroke Hill, Oxford, United Kingdom,⁴School of Pharmacy and Pharmaceutical Sciences, Cardiff University, Cardiff, United Kingdom, ⁵Department of Neurology, Universitätsklinikum Großhadern - Ludwig Maximilians Universität München, Munich, Germany

Background and aims: Phase II trials are investigating the effects of N-Acetyl-L-Leucine (IB1001/ALL) in 3 ultra-rare, autosomal-recessive, neurodegenerative disorders: Niemann-Pick disease, type C (NPC), Ataxia-telangiectasia (A-T) and GM2-Gangliosidosis (GM2). Owing to their overlapping phenotypes, and the mechanism of action of ALL, a single master protocol was developed, implementing both an innovative trial design and a novel primary endpoint, better suited to these small, inhomogeneous patient populations.

Methods: The IB1001 studies investigate the symptomatic and disease-modifying effects of ALL. Screening of patients ≥ 6 years (Europe) AND ≥ 18 years (USA) occurs at 12 centers across Germany, Spain, Slovakia, UK, and USA. Patients who have completed the Parent Study (Fig.1 and 2) may be included into an Extension Phase (Fig. 3) The dosage varies from 2 to 4g/day, based on patients' age/weight. A novel primary endpoint, the Clinical Impression of Change in Severity (CI-CS), was developed, based on two independent, blinded raters comparison of videos of the patient's change in performance from baseline to the end of treatment, and the end of treatment to the end of the washout on either the 8 Meter Walk Test (8MWT) or the 9 Hole Peg Test, Dominant Hand (9HPT-D).

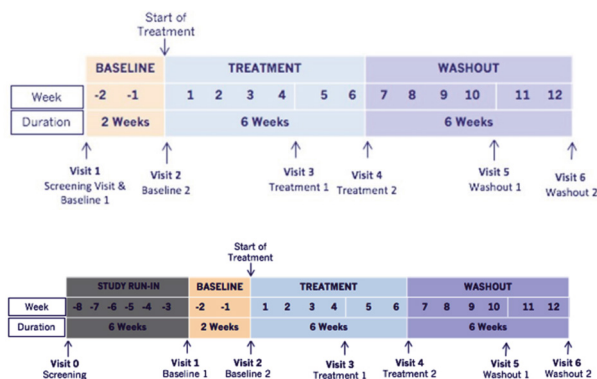

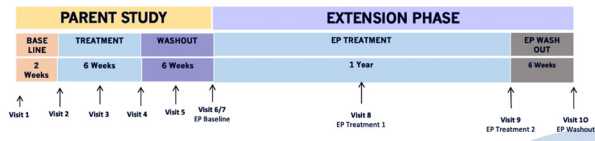

Results: Recruitment is ongoing for all 3 studies. Approximately 39 patients per study will be screened. As of 15 January 2020, 29 NPC, 13 GM2, and 1 A-T patients have been enrolled.

Conclusion: A novel primary endpoint is being implemented to better demonstrate the clinically meaningful effect of ALL treatment in three ultra-rare neurodegenerative diseases with overlapping phenotypes.

Disclosure: The IB1001 Clinical Trials are sponsored and paid for by IntraBio Ltd.

EPR1131

Acetyl-Leucine slows disease progression in lysosomal storage disorders

T. Breanova-Ertl¹, E. Kaya², D.E. Smith², C. Smith², L. Morris², M. Cortina-Borja³, P. Fineran², K.J. Morten⁴, J. Poulton⁵, J. Spencer⁶, M.L. Strupp⁷, F. Platt²

¹Berne, Switzerland, ²Department of Pharmacology, University of Oxford, Mansfield Road, Oxford OX1 3QT, Oxford, United Kingdom, ³Population, Policy and Practice Programme, Great Ormond Street Institute of Child Health, University College London, London, United Kingdom, ⁴Nuffield Department of Women's and Reproductive Health, University of Oxford, Oxford, UK, Oxford, United Kingdom, ⁵Nuffield Department of Women's and Reproductive Health, University of Oxford, Oxford, United Kingdom, ⁶Department of Chemistry, School of Life Sciences, University of Sussex, Brighton, Brighton, United Kingdom, ⁷Department of Neurology, Universitätsklinikum Großhadern - Ludwig Maximilians Universität München, Munich, Germany

Background and aims: Acetyl-DL-leucine (ADLL) is a derivative of the branched amino acid leucine. In observational clinical studies ADLL improved symptoms of ataxia in patients with the lysosomal storage disorder (LSD) Niemann-Pick disease type C (NPC). We investigated ADLL and its enantiomers acetyl-D-leucine (ADL) and acetyl-L-leucine (ALL) in *Npc1*^{-/-} mice.

Methods: Affected mice (*Npc1*^{-/-}, *Hexb*^{-/-}) and controls (*Npc1*^{+/+}, *Hexb*^{+/+}) were included. Behavioral tests were performed (gait analysis, motor function assessment, incl. strength and coordination). Biochemical analyses (Western blot, ADP/ATP and NAD/NADH, sphingoid base, glycosphingolipid, cholesterol) were performed. Moreover, lysotracker green staining, filipin staining as well as immunohistochemistry were conducted. Clinical observational studies of 13 adult NPC (12 on miglustat) and 3 GM2-gangliosidosis patients treated with ADLL were included.

Results: ADLL, ADL and ALL in symptomatic *Npc1*^{-/-} mice all improved ataxia. When ADLL and ALL were administered pre-symptomatically to *Npc1*^{-/-} mice, they both delayed disease progression and resulted in a modest extension to life span, whereas ADL did not. These data are consistent with ALL being the active neuroprotective enantiomer. Altered energy metabolism was implicated as a potential mechanism of action of the active L enantiomer in *Npc1*^{-/-} mice. When miglustat and ADLL were used in combination significant synergy resulted. Disease progression rates were slowed after 12 months of treatment. A neuroprotective effect of ADLL was also observed in a mouse model, and clinical benefit observed in GM2 gangliosidosis patients in observational clinical studies.

Conclusion: Taken together, we have identified an unanticipated neuroprotective effect of ALL, supporting its further evaluation in clinical trials in LSD.

Disclosure: Nothing to disclose

EPR1132

A reliable measure of rigidity with a novel robotic device

L. Caranzano¹, J. Madrid², F. Feuerstein³, T. Nef⁴,
D. Benninger¹

¹Lausanne, Switzerland, ²Neuroscience, CHUV, Lausanne university hospital, Lausanne, Switzerland, ³ARTORG Center for Biomedical Engineering Research, University of Bern, Berne, Switzerland, ⁴ARTORG Center for Biomedical Engineering Research University of Bern, Gerontechnology and Rehabilitation Group, Berne, Switzerland

Background and aims: Rigidity is 1 of the cardinal symptoms of Parkinson's disease (PD), which responds best to dopamine, but the pathogenesis is not yet understood. The assessment remains subjective depending on the examiner, and tremor may interfere with the assessment. A reliable measure of rigidity will allow determine more precisely the dopamine response and its interaction with bradykinesia for a better understanding of the pathophysiology of PD. The objective of our study was to objectively measure the rigidity in PD patients, using a recently validated robotic device

Methods: We studied 35 PD patients with (n=20) and without tremor (n=15), and 10 healthy subjects (HS). All participants underwent clinical evaluation including MD-UPDRS. The rigidity was assessed with the device, which measures the resistance of passive wrist flexion and extension movements at different speeds. PD patients with tremor underwent an additional tremor recording with surface EMG, inertial monitors and a writing tablet.

Results: Preliminary results show that the device records a hysteresis-shaped rigidity profile consistent with the literature, which differentiates PD patients from HS and correlates significantly with the UPDRS scores for rigidity. In PD patients with tremor, the device detects the tremor frequency, which correlates with the conventional tremor recording.

Conclusion: This device provides a reliable measure of rigidity for clinical studies and practice.

Disclosure: Nothing to disclose

Movement disorders 2

EPR1133

Association of the number of lost teeth with new-onset Parkinson’s disease; nationwide retrospective cohort study

Y. Chang, T.-J. Song

Department of Neurology, Ewha Womans University, Seoul, Korea, Republic of

Background and aims: Lost teeth is representative of poor oral hygiene. Poor oral hygiene can provoke transient bacteremia and systemic inflammation. Systemic inflammatory reaction may be related to the degeneration of dopamine neurons in the substantia nigra. We hypothesized that lost teeth would be associated with increased risk of new-onset Parkinson’s disease.

Methods: Between 2003 and 2006, we included 153,165 participants from the national health insurance system-health screening cohort in Korea without missing data for demographics, laboratory findings, comorbidities, and oral hygiene indicators (periodontal disease, dental clinic visit for any reasons, professional dental care, frequent tooth brushings, and number of lost teeth). The incidence of new-onset Parkinson’s disease was defined as International Classification of Diseases-10 code “G20” accompanying the prescription records for any anti-parkinson medication.

Results: Approximately 19.9% of the included participants had periodontal disease. After a median follow-up of 10.4 years, 1,227 (0.8%) new-onset Parkinson’s disease cases were noted. The number of lost teeth was positively associated with an increased risk of new-onset Parkinson’s disease. In contrast, frequent tooth brushings, dental clinic visit for any reasons, and professional dental care were negatively related to the occurrence of new-onset Parkinson’s disease. In multivariable analysis, number of lost teeth (≥ 15) remained positively related to occurrence of new-onset Parkinson’s disease (hazard ratio: 1.38, 95% confidence interval (1.03-1.85), $p=0.029$, p for trend=0.043).

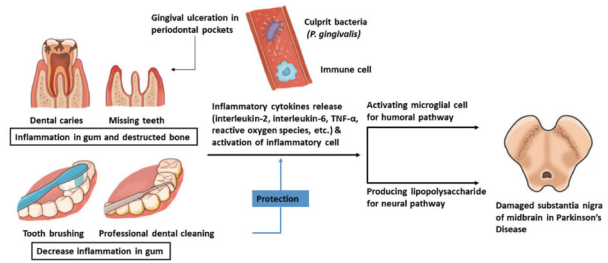

Disclosure: Nothing to disclose

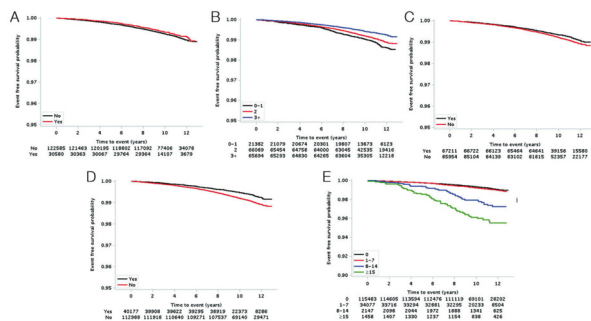

Conclusion: Increased number of lost teeth may be an augmenting factor for the risk of new-onset Parkinson’s disease.

EPR1134

Midbrain MRI morphometric measurements and MCI in Parkinson's disease: the PACOS study.

C.E. Cicero¹, G. Donzuso¹, A. Luca¹, M. Davi², R. Baschi³, G. Mostile¹, L. Giuliano¹, S. Palmucci⁴, R. Monastero³, M. Zappia⁵, A. Nicoletti¹

¹Catania, Italy; ²Department of Biomedicine, Neuroscience and advanced Diagnostic, University of Palermo, Palermo, Italy; ³Palermo, Italy; ⁴University of Catania, Catania, Italy; ⁵"GF Ingrassia" section of neurosciences, University of Catania, Catania, Italy

Background and aims: Mechanisms that lead Parkinson's disease (PD) patients to develop Mild Cognitive Impairment (MCI) are still poorly understood. Evidence from MRI studies have highlighted the progressive atrophy of several cortical areas involved especially in cognitive function. Nevertheless, data about subcortical structures, such as the midbrain and pons, that have an important role in cognitive functions, are often conflicting.

Methods: From the sample of the PACOS study, we selected patients with an available MRI and who underwent the morphometric measurements of midbrain and pons areas, Medium Cerebellar Peduncle (MCP) and Superior Cerebellar Peduncle (SCP) width and the midbrain anteroposterior diameter. MCI was diagnosed according to the MDS level II criteria. Univariate and multivariate logistic regression analysis have been performed for each of the measured structures.

Results: Morphometric measurements were available for 168 subjects. Among them 67 (39.9%) were diagnosed as PD-MCI. The mean age of the sample was 64.2±9.8 and 84 (50%) were men with a mean disease duration of 5.2±5.4 and a mean UPDRS-III of 32.1±12.9. At the univariate and multivariate analysis, after adjusting for age, sex, education and disease duration, MCI was associated with midbrain area (OR 0.98;95%CI 0.96-0.99; p=0.048) and with a midbrain anteroposterior diameter <16.4mm (OR 2.56;95%CI 1.22-5.33; p=0.012).

Conclusion: Midbrain atrophy is not a typical feature of PD, however a mild midbrain atrophy may represent a hallmark of PD-MCI, considering the cortical projections of the midbrain nuclei and their influence on executive and attentive functions.

Disclosure: Nothing to disclose

EPR1135

Does peripheral neuropathy affect gait and balance in Parkinson's disease?

M.F. Corrà¹, N.M.D.S. Vila-Chã¹, A.P. Sousa², I. Reis³, J. Damásio¹, S. Cavaco⁴, I. Ferreira¹, A.L. Sousa⁵, P. Salgado¹, M. Calejo¹, A. Sardoreira⁶, V. Oliveira¹, C. Hansen⁷, R. Magalhães⁸, R. Taipa⁹, W. Maetzler¹⁰, L.F. Maia¹, M. Correia⁶

¹Centro Hospitalar e Universitário do Porto - Hospital de Santo António, Porto, Portugal, ²Neurophysiology, Centro Hospitalar do Porto-Hospital Santo António, Porto, Portugal, ³Neuropathology, Centro Hospitalar do Porto, Porto, Portugal, ⁴Neuropsychology Unit, Centro Hospitalar do Porto - Hospital de Santo António, Porto, Portugal, ⁵Neurology, Centro Hospitalar do Porto - Hospital de Santo António, Porto, Portugal, ⁶Neurology, Centro Hospitalar do Porto, Porto, Portugal, ⁷Department of Neurology, University of Kiel, Kiel, Germany, ⁸Population Study Department, Instituto Ciências Biomédicas Abel Salazar, Porto, Portugal, ⁹Neurology Department and Neuropathology Unit, Centro Hospitalar do Porto - Hospital de Santo António, Porto, Portugal, ¹⁰Neurogeriatry, University of kiel, Kiel, Germany

Background: Parkinson's disease (PD) is a chronic neurodegenerative disorder. Peripheral neuropathy (PN) is often observed in PD patients than in non-PD subjects, with a prevalence between 10-40% (1-8% in non-PD subjects). We aimed in a prospective observational study to determine PN in a consecutive series of PD patients, identify the etiology and evaluate the functional impact on gait and balance.

Methods: A group of PD patients from Centro Hospitalar do Porto (CHUP) underwent clinical (Neuropathy Impairment Score; modified Toronto Clinically Neuropathy Score questionnaires), neurophysiological (nerve conduction studies; Quantitative Sensory Testing) and neuropathological (intraepidermal nerve fiber density in skin biopsies punches) examinations. Gait and balance were characterized using 3 wearable sensors (Hasomed, Germany) during ON and OFF states.

Results: We evaluated 98 patients, with a mean age of 67.1 (±9) ys and a mean disease duration of 6.6 (±5) ys. PN was present in 31 patients (31.6%). 8 patients showed axonal sensory polyneuropathy, 18 presented small fiber neuropathy and 5 had both large and small nerve involvement. The PN-PD group had lower straight walking velocity (p=0.01) and turning duration (p<0.05) during both medication states. During OFF state, PN-PD had higher JERK values, compared to non-PN-PD patients (P<0.05).

Conclusion: The prevalence of PN in our cohort is similar to previous reports. Preliminary analysis of gait and balance parameters suggest that peripheral nervous system involvement influences gait and balance parameters as measured with mobile digital technology during ON and OFF states. Ongoing research is focusing on better understanding of reasons for this phenomenon.

Disclosure: Nothing to disclose

EPR1136

A novel SGCE variant is associated with myoclonus dystonia in a Spanish family

J. Riancho¹, A. Matilla-Dueñas², S. Setién³,
J.R. Sánchez-de la Torre³, M. Misiego-Peral³,
M. Corral-Juan², M. Delgado Alvarado⁴

¹Torrelavega, Spain, ²Neurogenetics Unit, Department of Neuroscience, Research Institute Germans Trias i Pujol (IGTP), Badalona, Spain, ³Neurology Department, Sierrallana Hospital, Torrelavega, Spain, ⁴Biomedical Research Networking Center for Mental Health (CIBERSAM), Madrid, Spain

Background and aims: Hereditary myoclonus dystonia (DYT 11) associated with SGCE variants was described in 2001. We report a novel pathogenic nonsense mutation in SGCE found in a large Spanish family with multiple individuals affected.

Methods: A 58-year-old man presented to the emergency room with persistent diarrhea. In addition, the patient referred a history of abnormal posture and generalized jerks since childhood. No evidence of pregnancy abnormalities or developmental delays was noted. He denied intellectual impairment. He had earned a university degree and worked as a public server. He had never consulted with a neurologist. On examination, he showed severe cervical dystonia and spasmodic dysphonia. Moderate spontaneous myoclonus affecting the neck, arms, and trunk that worsened with activity was seen. Family history was positive for jerky movements in his father, 2 paternal aunts, his paternal grandmother and his son (figure 1). Only his son was available for examination, showing a much milder clinical picture that had started at the age of 3. Mild spontaneous myoclonus that affected trunk and proximal arms were seen. was an industrial engineer and practiced several sports. None of them noted alcohol responsiveness.

Results: Next Generation Sequencing analysis of the entire SGCE gene coding region revealed a previously unreported heterozygous nonsense mutation in exon 7, c.904A>T (p.Lys302Ter). The mutation was found (by Sanger) in the proband's son and was absent in a non-affected brother.

Conclusion: We report a novel nonsense mutation in exon 7 of the SGCE gene in a Spanish family with myoclonus dystonia and intrafamilial phenotypic variability.

Disclosure: Nothing to disclose

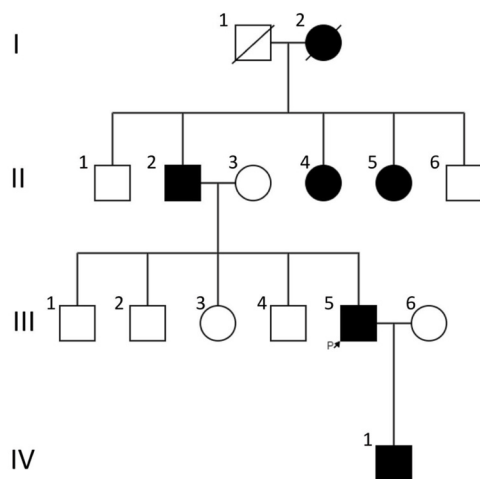

Family pedigree

EPR1137

Technology-based diagnostic, therapy-response and prognostic biomarkers in Parkinson's disease

G. Di Lazzaro¹, M. Ricci², M. Al-Wardat³, T. Schirinzi¹, F. Giannini², N.B. Mercuri⁴, G. Saggio², A. Pisani¹

¹Rome, Italy, ²Department of Engineer, Università degli studi Tor Vergata, Rome, Italy, ³System medicine, university of tor vergata, Rome, Rome, Italy, ⁴Department of Systems Medicine, Università Hospital of Rome Tor Vergata, Rome, Italy

Background and aims: One major unmet need in Parkinson's disease (PD) is the availability of non-invasive, early and reliable biomarkers, for diagnosis, prognosis and therapy response evaluation. Technology-based Objective Measures (TOMs) recently gained relevance in this field.

Our aim is to prospectively evaluate motor performances with technology-based objective measures (TOMs) in a cohort of Parkinson's disease patients in order to identify diagnostic, therapy response and progression biomarkers.

Methods: We enrolled 40 consecutive drug free PD patients and evaluated them clinically and with a set of wearable inertial sensors, during 7 motor tasks (tremor, four-limbs bradykinesia, timed-up-and-go test and pull test) at T0 and after 1 year. we followed them up for at least 2 years. we also enrolled 30 healthy subjects who underwent the kinematic assessment. Mann-Whitney test was performed between PD and HC features at T0, PD patients features at T0 and T1 and between T0 features of responder and non-responder patients.

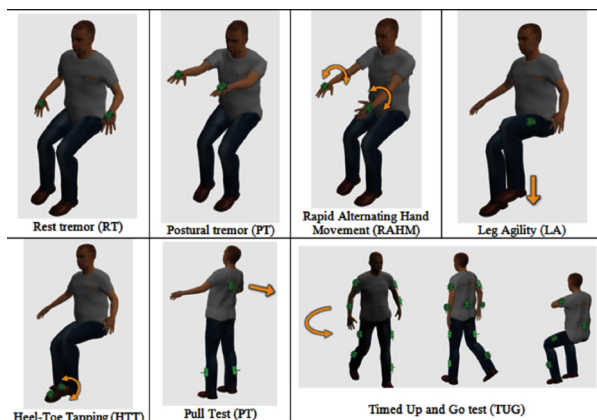

Sensors positioning during the 7 motor tasks evaluated (rest tremor, postural tremor, rapid alternating hand movement, leg agility, heel to toe test, pull test, timed-up-and-go test)

Results: 36 patients completed the study. We identified an algorithm able to discriminate HC from PD subjects with 97% accuracy. Then, among all kinematic features, at T1 at least one per task was significantly improved. Interestingly, many features from TUG test and PT ameliorated, even if they were scored as normal in UPDRS. In addition, one feature from upper limb bradykinesia and 6 features from TUG were significantly different between responder and non-responders at T0.

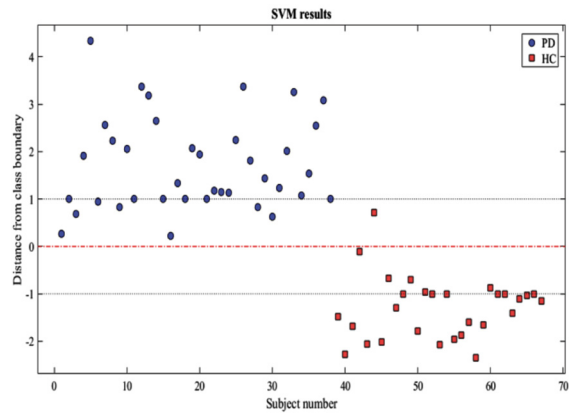

PD-HC classification

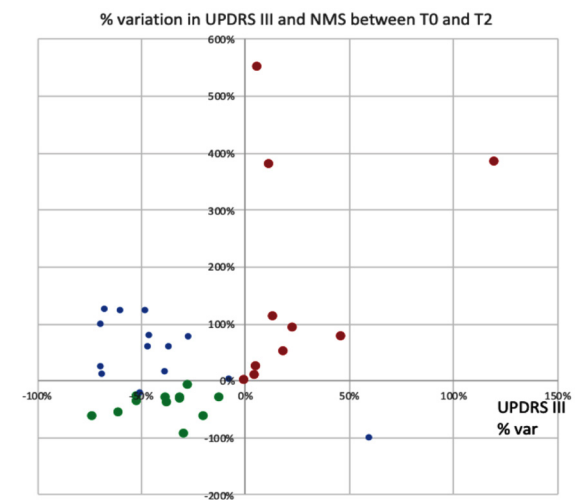

% variation of UPDRS and NMS after 24 months of dopaminergic therapy and identification of responder and non-responder patients

Conclusion: Our results demonstrate the possibility to objectively measure the efficacy of a therapeutic intervention in PD and identify candidates for early, technology-based prognostic and diagnostic biomarkers.

Disclosure: Nothing to disclose

EPR1138

Longitudinal clinical and neuroanatomical changes of PD-MCI Reverters

G. Donzuso¹, F. Agosta², E. Canu¹, T. Stojković³, S. Basaia¹, I. Stanković³, A. Tomic³, E. Stefanova³, V. Marković³, V.S. Kostic³, M. Filippi¹

¹Neuroimaging Research Unit, Institute of Experimental Neurology, Division of Neuroscience, IRCCS San Raffaele Scientific Institute, Milan, Italy, ²Neuroimaging Research Unit, Institute of Experimental Neurology, Division of Neuroscience; and Neurology Unit, IRCCS San Raffaele Scientific Institute and Vita-Salute San Raffaele University, Milan, Italy, ³Clinic of Neurology, Faculty of Medicine, University of Belgrade, Belgrade, Serbia

Background and aims: To investigate baseline and longitudinal clinical and neuroanatomical features of patients with Parkinson's disease who experienced mild cognitive impairment, but reverted to normal cognition overtime (PD-MCIr) compared to PD with normal cognition (PD-CN), stable MCI (PD-MCIs), and patients who converted to MCI (PD-MCIc) or dementia (PD-Dc).

Methods: We recruited 154 patients with known cognitive-outcome after 4 years: 12 PD-MCIr, 55 PD-CN, 37 PD-MCIc, 26 PD-MCIs, and 24 PD-Dc. All visits included neuropsychological/clinical assessments and MRI scans. Regional cortical thickness (CT) progression overtime was investigated within and between groups.

Results: At baseline, compared to PD-MCIc, PD-MCIs and PD-Dc, PD-MCIr patients had younger age, lower treatment dose, shorter disease duration, less motor and non-motor disturbances, and greater CT in the parieto-temporal cortices and subcortical regions. On the other hand, compared to PD-CN, PD-MCIr patients had lower education, performed worse in cognition, and experienced more gastrointestinal symptoms. Overtime, PD-MCIr patients showed a global worsening of motor and non-motor symptoms, and decreased CT in fronto-temporal regions, in a way similar to that of the PD-CN group. At the last visit, compared to PD-MCIc, PD-MCIs and PD-Dc cases, PD-MCIr patients still showed a better motor and non-motor condition, and thicker cortical structures.

Conclusion: PD-MCIr is associated to a mild phenotype and a relatively preserved brain structure relative to patients with a progressive cognitive decline. The PD-MCIr cognitive vulnerability seems to be independent of the progression of motor and (other) non-motor disturbances.

Disclosure: Supported by: Ministry of Education and Science, Republic of Serbia (Grant#175090).

EPR1139

Biochemical consequences of RAD51 mutations involved in congenital mirror movement disorder

M. Dunoyer¹, O. Trouillard², A. Meneret¹, O. Pourchet³, C. Fouquet³, I. Dusart³, C. Dubacq³, E. Roze¹

¹Département de Neurologie, Paris, France, ²Institut du Cerveau et de la Moelle - Hôpital Pitié-Salpêtrière, Paris, France, ³Institut de Biologie Paris-Seine - Sorbonne Université, Paris, France

Background and aims: Congenital mirror movement disorder (CMM) is a rare genetic disorder characterized by involuntary movements of 1 hand that mirror voluntary movements of the other hand. Developmental abnormalities of the cortico-spinal tract (CST) is the most striking associated anatomical abnormality. 4 mutations in the RAD51 gene have been identified in CMM patients. RAD51 is known for its nuclear function in DNA repair but, in cortico-spinal neurons, it is mainly detected in the cytoplasm. We hypothesized that performing its cytoplasmic function during the CST development would require properties similar to those needed to exert its nuclear role in DNA repair.

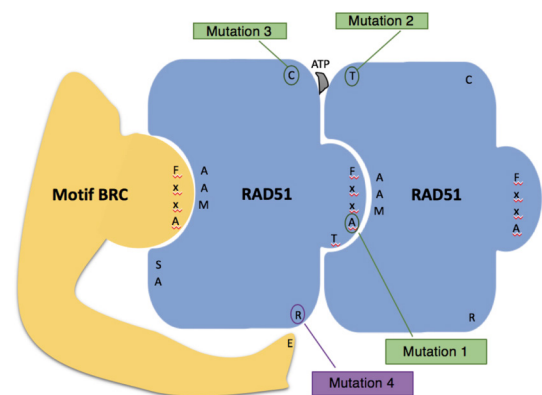

Schematic representation of the RAD51-RAD51 and RAD51-BRC interaction, and position of the 4 mutations responsible for CMM on the RAD51 protein.

Methods: We studied the biochemical properties of the various mutated RAD51 proteins by transfection of HEK 293 cells, co-immunoprecipitation of RAD51 proteins, pull-down with BRC peptides, and western-blot analysis. The wild-type protein was used as a control.

Results: We showed that 3 of the 4 mutations disturb the dimerization of RAD51, through alteration of RAD51/RAD51 interaction. Regarding the interaction with BRC peptides, no impact of the mutations could be highlighted.

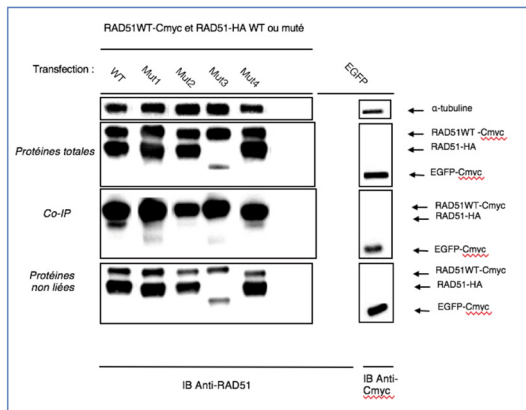

Study of the RAD51-RAD51 interaction by co-immunoprecipitation of RAD51WT-Cmyc and RAD51-HA WT/mutant in immunoblot. Immunoblots made with an anti-RAD51 antibody. Right EGFP-Cmyc track revealed by an anti-Cmyc antibody. The α -tubulin is revealed by an anti- α -tubulin antibody and makes it possible to verify the homogeneity of the protein deposit

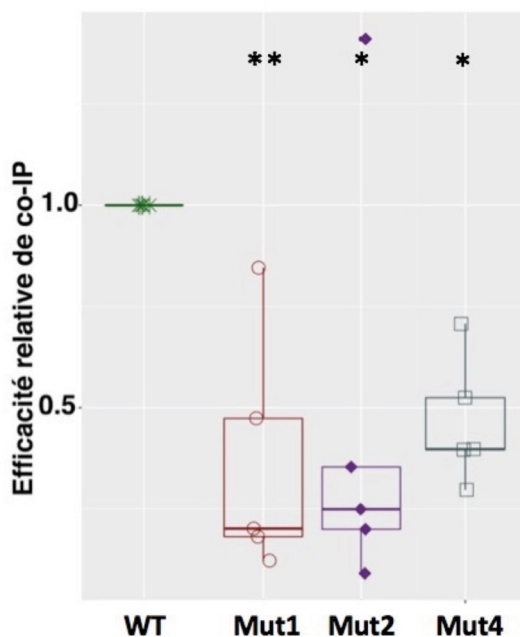

Statistical analysis of the co-IP of RAD51WT-cmyc with RAD51-HA WT or mutant. Quantification of the relative efficiency of co-IP expressed as a percentage of the RAD51WT condition for each independent experiment. ANOVA, $F(5,24) = 4.64$; $p = 0.004$ followed by a post-hoc Dunnett test, $* = p < 0.05$, $** = p < 0.01$.

Conclusion: As the dimerization defects of RAD51 results in defective oligomerization in the nucleus, our findings suggest that CMM mutations of RAD51 would likewise result in altered oligomerization of RAD51 in the cytoplasm. More studies are needed to further investigate the intracellular consequences of CMM RAD51 mutations and the exact role of RAD51 in the development of the CST.

Disclosure: Nothing to disclose

EPR1140

When and how to stop subthalamic deep brain stimulation in late stage Parkinson's disease

M. Fabbri¹, M. Zibetti², M.G. Rizzone³, G. Giannini⁴, L. Borellini⁵, A. Stefani⁶, F. Bove⁷, A. Bruno⁸, G. Calandra-Buonaura⁹, N. Modugno¹⁰, C. Piano⁶, A. Peppe⁶, G. Ardolino¹¹, A. Romagnolo³, C.A. Artusi¹², P. Berchiella¹³, E. Montanaro², P. Cortelli⁴, L.M. Romito⁵, R. Eleopra¹⁴, B. Minafra¹⁵, C. Pacchetti¹⁵, L. Lopiano¹²

¹Department of Neuroscience, University of Turin, Turin, Italy, ²Department of Neurological Science, University of Turin, Turin, Italy, ³Rita Levi Montalcini Department of Neuroscience, University of Torino, Turin, Italy, ⁴Bologna, Italy, ⁵Milan, Italy, ⁶Rome, Italy, ⁷Fondazione Policlinico Universitario A. Gemelli IRCCS, Rome, Italy, ⁸IRCCS Neuromed, Pozzilli, Pozzilli, Italy, ⁹Department of Biomedical and Neuromotor Sciences, University of Bologna, Bologna, Italy, Italy, ¹⁰IRCCS Neuromed Pozzilli, Isernia (Italy), Isernia, Italy, ¹¹Fondazione IRCCS Ca' Granda, Milan, Italy, ¹²Turin, Italy, ¹³University of Torino, Turin, Italy, ¹⁴Istituto Carlo Besta, Milan, Italy, ¹⁵IRCCS Mondino Foundation, Pavia, Italy

Background and aims: Subthalamic-deep brain stimulation (STN-DBS) effects may decrease with Parkinson's disease (PD) progression. There is currently no clear indication on how and when to consider the interruption of DBS treatment in late stage (LS) PD.

Our aim was to investigate the percentage of "poor stimulation responders" among LSPD patients in order to elaborate an algorithm to decide whether DBS interruption may be considered.

Methods: LSPD patients (Schwab and England ADL Scale < 50 and Hoehn Yahr Stage > 3 in Med On/Stim On) treated with STN-DBS for at least 5 years underwent a cross-over double-blind randomized evaluation of acute effects of stimulation. Physicians, caregivers and patients were blinded to stimulation conditions. Poor stimulation responders (Δ MDS-UPDRS part III < 10% Stim On/Med Off vs. Stim Off/Med Off) maintained the Stim Off/Med On condition during one month for open label assessment.

Results: 36 patients were included (Table 1). The acute effect of stimulation was significant (17% improvement at the MDS-UPDRS part III Stim On/Med Off vs. Stim Off/Med Off). 7 patients (20%) were classified as "poor stimulation responders" (Table 2). After 1 month, 4 switched stimulation back "On" due to worsening of parkinsonism, dysphagia and scialorrea, with a variable time delay (up to 10 days) (Figure 1). No serious adverse effects occurred.

Table 2

Characteristic	PLC	OPC 50 mg
	N=59	N=68
Patients with at least possibly related ^a TEAEs, n (%)	13 (22.0)	30 (44.1)
Most frequently reported ^b at least possibly related ^a TEAEs, n (%)		
Dyskinesia	1 (1.7)	8 (11.8)
Constipation	0	4 (5.9)
Nausea	4 (6.8)	1 (1.5)
Patients with at least possibly related ^a TEAEs leading to discontinuation, n (%)	5 (8.5)	5 (7.4)

^aRelationship to study medication reported as 'possible', 'probable', 'definite' or missing; ^b≥5% of patients in either group
OPC, opicapone; PLC, placebo; TEAE, treatment-emergent adverse event

Table 3

Conclusion: OPC 50mg demonstrated efficacy and was generally well tolerated in PD patients treated with levodopa-only, suggesting that OPC is a viable option as a first-line adjunctive therapy in levodopa-treated PD patients with motor fluctuations.

1. Ferreira et al., *Lancet Neurol.* 2016;15(2):154-165.

2. Lees et al., *JAMA Neurol.* 2017;74(2):197-206.

Disclosure: Study supported by Bial - Portela & C^a, S.A.

EPR1142

Prediction of the effect of deep brain stimulation on gait freezing of Parkinson's disease

O. Gavriiliuc¹, S. Paschen², A. Andrușca³, C. Schlenstedt², G. Deuschl²

¹Department of Neurology, State University of Medicine and Pharmacy Nicolae Testemitanu, Chisinau, Moldova,

²Department of Neurology, UKSH, Kiel Campus; Christian-Albrechts-University, Kiel, Germany, ³Department of Neurosurgery, State University of Medicine and Pharmacy Nicolae Testemitanu, Chisinau, Moldova

Background and aims: The response of freezing to deep brain stimulation of the subthalamic nucleus (STN-DBS) is controversial and obviously depending very much on factors which are poorly controlled. On the other hand, a clinical predictor for the individual patient is needed to counsel the patient regarding this symptom.

Methods: A cohort of 124 patients undergoing STN-DBS has been evaluated based on the video-documented Levodopa test at baseline and the outcome in the worst and best condition 1 year postoperatively. We compared the freezing item of the Unified Parkinson's disease rating scale (#14), the UPDRS total score, and a severity rating of 4 freezing subtypes with regard to its predictive value.

Results: We found 'freezing during the turning task' to be the best predictor with a ROC-value of 0.857 compared to 0.603 for the UPDRS Item 14 and 0.583 for the total UPDRS III. An improvement of 1 or 2 grades of the turning item during the preoperative levodopa test predicts an improvement during the worst condition postoperatively of 1 grade or more with an 80% probability.

Conclusion: This freezing prediction test is simple and clinically useful. The test needs to be studied in a prospective study.

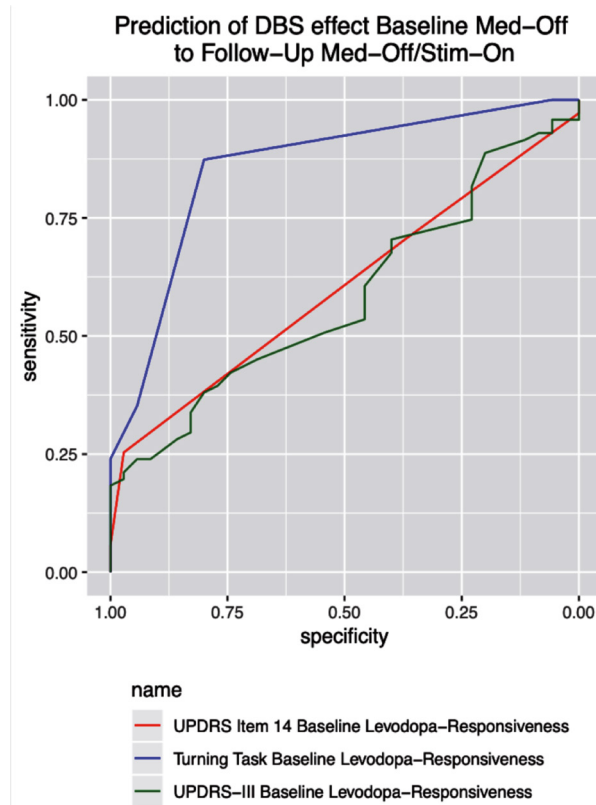

Figure 1. Prediction of DBS effect baseline Med-OFF to follow-up Med-Off/Stim-On.

Disclosure: Nothing to disclose

EPR1143

Unusual Complications related to LCIG treatment-The Cretan Parkinson Disease Cohort-A ten years prospective observational study.

C. Spanaki¹, M. Koulentaki², M. Raissaki³, E.A. Giannopoulou⁴, I. Boura⁵, E. Grammatikaki⁶, E. Giakoumakis⁶, E. Athanasakis⁷, P. Mitsias¹
¹Neurology, University Hospital of Heraklion, Crete, Heraklion, Crete, Greece, ²Gastroenterology, University Hospital of Heraklion, Heraklion, Greece, ³Radiology, University Hospital of Heraklion, Heraklion, Greece, ⁴Neurology, University of Crete, School of Medicine, Heraklion, Greece, ⁵Neurology, University of Crete, School of Medicine, IRAKLIO, Greece, ⁶Neurology, University Hospital of Heraklion, Heraklion, Greece, ⁷Surgery, University Hospital of Heraklion, Heraklion, Greece

Background and aims: Enterally administered Levodopa/Carbidopa Intestinal Gel (LCIG) is a device-aided treatment for the management of intractable motor complications that characterize the advanced stages of Parkinson's disease (PD). Although considered safe, LCIG treatment can be associated with short- and long-term complications. Its safety has been studied in retrospective and prospective studies of relatively short duration. The aim of our study was to report unusual complications related to the LCIG treatment over a course of 10 years.

Methods: A prospective observational cohort study on the safety of LCIG treatment in advanced PD patients was conducted from 2009 to 2019.

Results: 40 patients received LCIG treatment during the study period. 3 patients (7.5%) discontinued the LCIG treatment due to treatment-related side effects. 1 patient developed double gastric ulcer and intestinal perforation with dislocation of the intestinal tube to the jejunum and another 1 developed severe psychosis. 33 patients (82.5%) remained on LCIG treatment and were followed regularly. 5 of them (15%) developed buried-bumper syndrome which was efficiently managed surgically without discontinuing treatment. 3 patients (9%) lost their teeth. 9 patients (27%) suffered bone fractures due to falls. 1 patient (3%) on LCIG monotherapy developed impulse control disorder and another 1 (3%) fecal incontinence. 3 patients (9%) required significant levodopa dose reduction due to psychotic symptoms.

Conclusion: LCIG treatment is a life-changing device-aided treatment for advanced PD patients. Complications are not uncommon. Most of them are easily managed. Severe treatment-related adverse events that require LCIG treatment discontinuation can occur but are rare.

Disclosure: Nothing to disclose

EPR1144

Changes in brain network topology as a function of a cognitively engaged lifestyle in Huntington's disease: a longitudinal resting-state fmri and diffusion tensor imaging study

B. González-Herrero¹, A. Palomar-García², P. Canal-Noguer², C. García-Gorro², N. Rodríguez-Dechicha³, I. Vaquer³, S. Subira³, M. Calopa¹, S. Martínez-Horta⁴, J. Pérez-Pérez⁴, J. Kulisevsky⁴, E. Muñoz⁵, P. Santacruz⁵, J. Ruiz-Idiago⁶, C. Mareca⁶, R. De Diego-Balaguer², E. Cámara²
¹Bellvitge University Hospital, Neurology - Movement Disorders Unit, Barcelona, Spain, ²Cognition and Brain Plasticity Group, IDIBELL, Barcelona, Spain, ³Hestia Duran i Reynals. Duran i Reynals Hospital, Barcelona, Spain, ⁴Sant Pau Hospital, Neurology - Movement Disorders Unit, Barcelona, Spain, ⁵Hospital Clinic, Neurology - Movement Disorders Unit, Barcelona, Spain, ⁶Mare de Deu de la Mercè Hospital, Barcelona, Spain

Background and aims: Huntington's disease (HD) is an inherited neurodegenerative disorder which affects the cortico-striatal network leading to highly individual differences of motor, cognitive and psychiatric symptoms. Understanding the sources of this variability is crucial to be able to develop preventive strategies that may change the progression of the symptoms. In terms of protecting against cognitive impairment, a cognitively engaged lifestyle (CEL) has been shown to ameliorate cognitive decline, however, the underlying neurobiological basis remains largely unknown. Network analysis provides a new perspective for understanding how CEL may modulate brain changes. In this study, we aimed to explore the relationship between CEL and the longitudinal changes in brain structural and functional topology, using graph analysis.

Methods: Thirty-three HD individuals were scanned longitudinally and evaluated for CEL using the Cognitive reserve questionnaire. Topological organization of whole-brain structural and functional network was calculated using diffusion and resting state MRI. Then, correlation analysis was performed between changes in topological measures and CEL.

Results: CEL showed a negative correlation with longitudinal change of mean functional and structural betweenness, modularity and average shortest path length, suggesting that HD individuals with higher CEL scores are better able to cope with the effects of pathology. These findings indicate that despite the burden of pathology, they have a higher ability for processing and distributing specialised information across the network and less vulnerability to disruption in highly connected nodes.

Conclusion: Our study suggests that a CEL may promote brain maintenance by modulating the topological and dynamical brain network's properties and conferring protection against neurodegeneration.

Disclosure: Nothing to disclose

MS and related disorders 1

EPR1145

Motor disability assessment in the Google Maps era: a feasibility study to test a digital tool

G. Abbadessa¹, L. Lavorgna¹, P. Iaffaldano², R. Lanzillo³, S. Esposito¹, D. Ippolito¹, M. Sparaco¹, S. Cepparulo¹, G. Lus¹, R. Viterbo⁴, M. Clerico⁵, F. Trojsi¹, P. Ragonese⁶, G. Borriello⁷, E. Signoriello¹, R. Palladino⁸, M. Trojano⁹, G. Tedeschi¹, S. Bonavita¹

¹University of Campania Luigi Vanvitelli, Naples, Italy, ²Department of Basic Medical Sciences, Neurosciences and Sense Organs, University of Bari, Bari, Italy, ³Department of Neurological Sciences, Policlinico Federico II, Second University of Naples, Naples, Italy, ⁴University of Bari Aldo Moro, Bari, Italy, ⁵ORBASSANO (TO), Italy, ⁶Palermo, Italy, ⁷Ospedale Sant'Andrea, Rome Italy, ⁸Department of Public Health, Federico II University, Naples, Italy, ⁹Bari, Italy

Background and aims: Ambulation score (As) plays a major role in the final EDSS scoring. Aim of our study is to evaluate whether the use of Google Maps application in calculating the As in clinical practice may improve the accuracy of EDSS scoring in MS patients.

Methods: 243 MS patients were recruited. We evaluated: 1) the As based on the Maximum Walking Distance (MWD) referred by the patients (pAS), 2) the As based on MWD identified on Google Maps (gmAs), 3) the agreement between these 2 measurements. We evaluated whether demographic and clinical data might have influenced the belonging to the group of MS patients with pEDSS congruent with gmEDSS (unchanged group) or MS patients with pEDSS different from gmEDSS (changed group). Finally, in a subgroup of patients we tested the consistency among these 2 measurements and the As objectively measured (actAS). For statistical analysis Spearman correlation test and Intraclass Correlation Coefficient (ICC) were used.

Results: One third of MS patients of our sample reported a pAS different from the gmAS. Progressive phenotype were more likely to belong to the changed group as well as fatigued or depressed patients. Considering the subgroup in which the As was objectively measured, in 45.3% of patients the pAS corresponded to actAS while the degree of concordance increased to 60% when considering gmAS and actAS.

Table 1 – Whole population; demographic and clinical features

	Total (n=243)		EDSS <=3.5 (n=142)		EDSS >=4 (n=101)		P
	n	%	n	%	N	%	
Sex							
Female	173	71.19	97	68.31	76	75.25	
Male	70	28.81	45	31.69	25	24.75	0.239
Age							
Mean, sd							
Median (Q1-Q3)							
Disease type							
CIS	1	0.41	1	0.70	0	0.00	
RR	210	86.78	140	98.59	70	69.31	
SP	22	9.09	1	0.70	21	20.79	
PP	9	3.72		0.00	9	8.91	<0.001
Disease duration							
mean, sd	9.60	7.83	7.75	6.39	12.2	8.9	<0.001
median (Q1-Q3)	7	3-13	6	3-11.3	10	5.5-17	
Ongoing therapy							
Copaxone	19	7.82	13	9.15	6	5.94	
INF	51	20.99	35	24.65	16	15.84	
DMF	52	21.4	35	24.65	17	16.83	
Terifunomide	16	6.58	5	3.52	11	10.89	
Fingolimod	46	18.93	26	18.31	20	19.80	
Natalizumab	36	14.81	20	14.08	16	15.84	
Alemtuzumab/Altro	10	4.12	2	1.41	8	7.92	
Nessuna	13	5.35	6	4.23	7	6.93	

Table 2 – Whole population; clinical scores

	Totale n=243		EDSS <=3.5 n=142		EDSS >=4 n=101		p
	mean, sd	median (Q1-Q3)	mean, sd	median (Q1-Q3)	mean, sd	median (Q1-Q3)	
FSStot	30.63	16.09	24.27	13.94	39.56	14.65	<0.001
PHQ91	7.52	6.07	5.6	5.22	10.22	6.17	<0.001
ASp	1.20	1.71	0.11	0.49	2.74	1.62	
EDSSp	3.24	1.67	1.97	0.7	5.03	0.73	
ASgm	1.11	1.70	0.23	0.74	2.35	1.9	
EDSSgm	3.24	1.65	2.15	1.03	4.77	1.05	

Abbreviations: pAS = perceived Ambulation Score; pEDSS = perceived Expanded Disability Status Scale; gmAS = Google Maps Ambulation Score; gmEDSS = Google Maps Expanded Disability Status Scale; actAS = actual (objective) Ambulation Score; actEDSS = actual (objective) Expanded Disability Status Scale; FSS = Fatigue Severity Scale; PHQ-9 = Patient Health Questionnaire-9.

Table 3 - Multinomial logistic model – Factors influencing the belonging to the changed group (CG) or unchanged group (UG)

Variables	ODDS RATIO (OR)	95 % Confidence Interval (95% CI)		P value	
Intercept	0.02			<.0001	
Disease type	PP/SP vs RR	2.8	1.1	7.11	0.03
age, years		1.02	0.99	1.06	0.164
Level of education, years		0.95	0.86	1.05	0.321
disease duration, years		1.03	0.98	1.07	0.208
FSS		1.03	1.01	1.06	0.01
PHQ-9		1.1	1.04	1.17	0.002

Abbreviations: PP = Primary Progressive Multiple Sclerosis; SP = Secondary Progressive Multiple Sclerosis; RR = Relapsing-Remitting Multiple Sclerosis; FSS = Fatigue Severity Scale; PHQ-9 = Patient Health Questionnaire-9.

Conclusion: Google Maps technology is a feasible tool that could permit to measure MWD increasing the concordance with actual measure especially in pwMS with moderate disability, where MWD heavily influences the final EDSS score.

Disclosure: Nothing to disclose

EPR1146

Long-term follow-up of three-times-weekly glatiramer acetate: 7-year results of the Glatiramer Acetate Low-Frequency Administration (GALA) open-label extension study

P. Rieckmann¹, J. Alexander², S. Kadosh³, S. Rubinchick⁴, Y. Stark⁴, R. Zivadinov⁵

¹Medical Park, Loipl, Germany, ²Teva Pharmaceuticals, Colorado, USA, ³Former employee of Teva Pharmaceuticals, Netanya, Israel, ⁴Teva Pharmaceuticals, Netanya, Israel, ⁵University at Buffalo, Buffalo, USA

Background and aims: The 1-year GALA study showed that glatiramer acetate (GA) 40mg/mL (GA40) reduced annualized relapse rate (ARR) and MRI activity versus placebo in patients with relapsing multiple sclerosis. Here, we describe effects of early start (ES) and delayed start (DS) GA40 treatment for up to 7 years.

Methods: Clinical evaluations occurred every 6 months. ARR was the primary endpoint; additional endpoints were exploratory or post hoc analyses.

Results: 1404 patients randomized to GA (N=943) or placebo (N=461); 834 (88.4%) ES and 419 (90.9%) DS patients continued into open-label (OL). ARR was 0.26 for ES and 0.31 for DS (RR: 0.83; 95% CI: 0.700, 0.993; P=0.0409). Percent of patients without relapse was 48.1% ES and 44.0% DS, and during only the OL was 60.7% ES and 65.9% DS. ES prolonged median time to relapse (4.9 years) versus DS (4.3 years; hazard ratio [HR]: 0.82; 95% CI: 0.693, 0.959; P=0.0135). Percent of patients without 6-month CDP was 81.9% ES and 81.3% DS, and HR for time to 6-month CDP of ES versus DS was HR=0.89; 95% CI 0.688, 1.157; P=0.3898. 49.3% of ES and 46.2% of DS patients were free of clinical disease activity. The most common adverse events (AEs), injection-site reactions and immediate post-injection reactions, were generally mild and consistent with the GA safety profile.

Conclusion: No new AEs emerged in patients receiving GA40 for up to 7 years. Treatment with GA40 was associated with low ARR and CDP in patients continuing on GA40 and those switching from placebo.

Disclosure: Funded by Teva Pharmaceutical Industries, Petach Tikva, Israel.

EPR1147

Evidence for Improved Myelination in Patients Treated with Siponimod: Results from the Phase 3 EXPAND MRI Substudy

D.L. Arnold¹, P. Vermersch², B.A.C. Cree³, A. Bar-or⁴, G. Giovannoni⁵, R. Gold⁶, D. Piani-Meier⁷, S. Arnould⁷, S. Ritter⁸, G. Karlsson⁷, L. Kappos⁹, R.J. Fox¹⁰

¹NeuroRx Research, Montreal, Quebec, Canada, ²University Lille, Lille, France, ³UCSF Weill Institute for Neurosciences, Department of Neurology, University of California San Francisco, San Francisco, California, USA, ⁴Center for Neuroinflammation and Experimental Therapeutics and Department of Neurology, Perelman School of Medicine, University of Pennsylvania, Philadelphia, Pennsylvania, USA, ⁵Blizard Institute, Barts and The London School of Medicine and Dentistry, Queen Mary University of London, London, United Kingdom, ⁶Department of Neurology, St Josef-Hospital/Ruhr-University Bochum, Bochum, Germany, ⁷Novartis Pharma AG, Basel, Switzerland, ⁸Novartis Pharmaceuticals Corporation, East Hanover, New Jersey, USA, ⁹Neurologic Clinic and Policlinic, Departments of Medicine, Clinical Research, Biomedicine and Biomedical Engineering, University Hospital and University of Basel, Basel, Switzerland, ¹⁰Mellen Center for Treatment and Research in Multiple Sclerosis, Neurological Institute, Cleveland, Ohio, USA

Background and aims: Changes in magnetisation transfer ratio (MTR) are widely used as a marker of changes in myelin density in brain. In preclinical studies, siponimod showed evidence of remyelinating effects. This exploratory analysis assessed the effect of siponimod on MTR versus placebo in different brain regions, and MTR recovery within lesions.

Methods: This prospective, MTR EXPAND substudy included 633 2ndary progressive multiple sclerosis (SPMS; siponimod [n=409]; placebo [n=224]) patients. MTR was analysed in normal-appearing brain tissue, cortical grey matter and normal-appearing white matter at baseline, Month (M)12 and M24. MTR was normalised to reduce MTR variability across scanners. Median absolute normalised MTR (nMTR) change from baseline expressed in percent units was derived from mixed models for repeated measures. MTR recovery metrics were assessed in new MTR lesions comparing nMTR decrease from pre- to post-lesion timepoints for siponimod versus placebo.

Results: Siponimod reduced median nMTR decrease from baseline to M12 and M24 versus placebo across brain tissues. Decrease was lower with siponimod at M24 across tissues by -55% to -98% (p<0.05; Table). In normal-appearing white matter, siponimod appeared to have fully prevented a decrease in nMTR. Lesion MTR recovery favoured siponimod (-1.321) versus placebo (-1.506; difference, 0.185 [0.056; 0.314]; p=0.005).

Table. Absolute change from baseline in median normalised MTR (percent unit) by brain tissue

Brain tissue	Adjusted means		% Reduction; p-value
	Siponimod (N=409) (N=327)	Placebo (N=224) (N=180)	
Normal-appearing brain tissue			
M12	-0.016	-0.024	-38%; p=0.3178
M24	-0.022	-0.056	-61%; p=0.0187
Cortical grey matter			
M12	-0.019	-0.026	-27%; p=0.4236
M24	-0.025	-0.056	-55%; p=0.0468
Normal-appearing white matter			
M12	0.002	-0.019	-105%; p=0.0209
M24	-0.001	-0.045	-98%; P=0.0018

N, number of patients included in the MTR sub-study (with any MTR data)
 N', number of patients included in the analysis (i.e. with at least one result post-baseline)
 Absolute median normalised MTR change from baseline was derived from mixed models for repeated measures adjusted for treatment, region, age, visit, baseline median normalised MTR of the respective brain tissue, baseline number of gadolinium-enhancing T1 lesions, baseline T2 lesion volume and treatment by visit and baseline median normalized MTR by visit interactions as covariates
 M, month; MTR, magnetisation transfer ratio

Table. Absolute change from baseline in median normalised MTR (percent unit) by brain tissue

Conclusion: Siponimod demonstrated a consistent and significant effect on the MTR decrease over time in normal-appearing white matter and cortical grey matter versus placebo, and improved MTR recovery in newly formed lesions. These data are consistent with observations in preclinical models and support potential beneficial effects of siponimod on remyelination in SPMS patients.

Disclosure: This study was funded by Novartis Pharma AG, Basel, Switzerland. A detailed disclosure from each author will be included in the oral/poster presentation. Abstract also submitted to AAN 2020; acceptance pending.

EPR1148

Inflammatory markers for predicting progression in Multiple Sclerosis: An Indian story

P. Banerjee¹, D. Khurana¹, B. Saikia², K. Jangra³

¹Neurology, PGIMER, Chandigarh, Chandigarh, India,

²Immunopathology, PGIMER Chandigarh, CHANDIGARH, India, ³Neuroanaesthesia, PGIMER Chandigarh,

Chandigarh, India

Background and aims: Cytokines have been widely studied as potential inflammatory markers in Multiple Sclerosis (MS) though no data from South Asia is available to contribute to this concept. We studied the cytokine profiles in treatment naïve and off-treatment Multiple Sclerosis patients in order to establish a marker panel for early prediction of progression.

Methods: Paired CSF (Cerebrospinal fluid) and serum samples were collected from N=47 treatment naïve RRMS, N=20 treatment naïve or on no DMT (Disease-modifying treatment) for last one-year SPMS patients [Inclusion criteria: Age 18-65years, EDSS <6.5, having no recent history of long term infection] and N=50 matched healthy controls. 27 cytokines were analysed by BIORAD Bio-plex ProTM human cytokine standard 27 plex kit. The reference point of comparison was taken as Healthy control levels. Only the statistically significant (p<0.05) and showing similar trends in both blood and CSF were considered.

Results: Described in detail in Figure 1.

Results:

N=67 total MS patients were taken amongst which N=47 were RR and N=20 were SP. The mean age at diagnosis for both groups combined were 27±9.5 and the female:male ratio was 1.5:1. In the RR group, the most common first symptoms at presentation was Brainstem-cerebellum (43.7%) whereas in SP was spinal cord and optic (53%). The mean baseline EDSS was 1.8± 1.2 in RR and 4.7± 2.23 in SP. The median duration of disease in the RR group 1.3 ±0.34 and 8.01± 0.4 for SP. Baseline median annualized relapse rates (ARR) were 1.76 ±1.2 and 0.76 ±0.26 for RR and SP groups, respectively. In the SPMS population, pro-inflammatory cytokines TNF alpha, IFNγ, IL9, MIP1a, MIP1b, IL2, IL7 were observed to be upregulated (p<0.05). VEGF was downregulated (p<0.05) whereas RANTES was only observed in CSF. The anti-inflammatory cytokines IL1ra, IL13, FGFb were also upregulated in SPMS samples whereas GCSF was lower in as compared to the RR group (p<0.05). IL10 was observed only in CSF with an upregulation in SPMS. The sensitivity and specificity of these markers combined for the SPMS patients compared to RRMS were 94.8%. The upregulated pro-inflammatory cytokines were associated with disease severity defined by increased annualised relapse rates and with an increase in EDSS in the RR group (12.7%) directing towards these patients inclination to move to early progression. Levels of all cytokines were significantly higher in both MS groups compared to the healthy controls (specificity=98.3%).

Figure 1: Result summary

Conclusion: The upregulation of both kinds of cytokines was consistent with the neuronal tissue damage. Specifically, the increased levels of most anti-inflammatory cytokines bear testimony to the non-relapsing progressive nature observed in the SPMS phase. It can be well stated that the above set of reported cytokines (TNF alpha, IFNγ, IL9, MIP1a, MIP1b, IL2, IL7, VEGF, RANTES, IL1ra, IL13, FGFb, IL10) holds potential as a panel for prediction of progression although validation in a larger cohort is necessary with real-time long term follow-ups of patients moving to the progressive phase to further find correlations with other clinical and imaging findings.

Disclosure: The research project was supported by the home Institution PGIMER, Chandigarh as part of the Intramural project scheme.

EPR1149

B-cells, T-cells and inflammatory CSF biomarkers in primary progressive MS and relapsing MS in the OBOE (Ocrelizumab Biomarker Outcome Evaluation) trial

A. Bar-or¹, J. Bennett², H.C. Von Büdingen³, R. Carruthers⁴, K. Edwards⁵, R. Fallis⁶, D. Fiore⁷, J. Gelfand⁸, P. Giacomini⁹, B. Greenberg¹⁰, D. Hafler¹¹, E. Longbrake¹¹, C. Ionete¹², U. Kaunzner¹³, C. Lock¹⁴, X. Ma⁷, B. Musch⁷, G. Pardo¹⁵, J. Pei⁷, F. Piehl¹⁶, M. Weber¹⁷, T. Ziemssen¹⁸, A. Herman⁷, C. Harp⁷, A. Cross¹⁹

¹Perelman School of Medicine, University of Pennsylvania, Philadelphia, PA, USA, ²University of Colorado, Denver, CO, USA, ³F. Hoffmann-La Roche Ltd, Basel, Switzerland, ⁴University of British Columbia, Vancouver, BC, Canada, ⁵MS Center of Northeastern New York, Latham, NY, USA, ⁶The Ohio State University Medical Center, Columbus, OH, USA, ⁷Genentech, Inc., South San Francisco, CA, USA, ⁸University of California, San Francisco, San Francisco, CA, USA, ⁹McGill University, Montreal, QC, Canada, ¹⁰The University of Texas Southwestern Medical Center, Dallas, TX, USA, ¹¹Yale School of Medicine, New Haven, CT, USA, ¹²University of Massachusetts, Worcester, MA, USA, ¹³Weill Cornell Medical College, New York, NY, USA, ¹⁴Stanford University, Stanford, CA, USA, ¹⁵Oklahoma Medical Research Foundation, Oklahoma City, OK, USA, ¹⁶Karolinska University Hospital, Solna, Sweden, ¹⁷University Hospital Göttingen, Göttingen, Germany, ¹⁸TU Dresden, Dresden, Germany, ¹⁹Washington University School of Medicine, St. Louis, MO, USA

Background and aims: Ocrelizumab is an anti-CD20 molecule that reduces progression in MS. Less is known about biomarkers and anti-CD20 mechanisms of action in primary progressive MS (PPMS) than relapsing MS (RMS). Presence of T1 gadolinium-enhancing lesions have been associated with higher baseline cerebrospinal fluid (CSF) neurofilament light (NfL) and serum NfL (sNfL) levels in PPMS and RMS and significant treatment-related sNfL reductions in PPMS (ORATORIO). We assessed longitudinal changes in B-cells, T-cells, NfL and soluble inflammatory markers in patients from the OBOE study.

Methods: 28 patients with PPMS received ocrelizumab 600mg every 24 weeks. Blood and CSF samples were assessed for NfL, CXCL13, CCL19 and CSF B- and T-cells. Data were compared with previously reported RMS data.

Results: Baseline CSF B-cells, T-cells and CCL19 levels were indistinguishable between patients with PPMS and RMS, whereas CSF NfL ($p=0.012$) and CXCL13 ($p=0.020$) levels were decreased in PPMS. PPMS CSF B-cell ($n=15$; median percent change, -100 [IQR -100 , -91.4]; $p<0.001$) and T-cell ($n=17$; -63.69 [IQR -80.5 , -12.9]; $p=0.051$) counts were reduced at 52 weeks post-treatment. Neither CSF NfL nor sNfL levels were decreased at 52 weeks; however, NfL trended lower in 7 patients with PPMS with baseline T1 gadolinium-enhancing lesions vs those without.

PPMS CSF CXCL13 levels were reduced following ocrelizumab treatment, but this was nonsignificant.

Conclusion: Baseline CSF B-cell, T-cell and inflammatory biomarker levels were similar in PPMS and RMS. CSF B-cell, T-cell and CXCL13 levels were reduced following ocrelizumab treatment in PPMS and RMS.

Disclosure: Sponsored by F. Hoffmann-La Roche Ltd; editorial assistance was provided by Health Interactions, USA.

EPR1150

Blood neurofilament light levels are reduced following ocrelizumab treatment in patients with relapsing and primary progressive multiple sclerosis

A. Bar-or¹, G.-A. Thanei², C. Harp³, A. Cross⁴, S. Hauser⁵, X. Jia³, J. Kuhle⁶, D. Leppert⁶, F. Model², D. Fiore³, H. Koendgen², R. Hendricks³, S. Fischer³, M. Manfrini², A. Herman³

¹Perelman School of Medicine, University of Pennsylvania, Philadelphia, PA, USA, ²F. Hoffmann-La Roche Ltd, Basel, Switzerland, ³Genentech, Inc., South San Francisco, CA, USA, ⁴Washington University School of Medicine, St. Louis, MO, USA, ⁵University of California, San Francisco, San Francisco, CA, USA, ⁶University Hospital Basel, University of Basel, Basel, Switzerland

Background and aims: Neurofilament light (NfL) is a marker of neuroaxonal injury. Ocrelizumab (OCR) reduced disease activity and progression in patients with relapsing multiple sclerosis (RMS) and primary progressive multiple sclerosis (PPMS) from the OPERA and ORATORIO trials. Here, we investigated blood NfL levels and changes over time following OCR initiation.

Methods: Patients with RMS (OPERA: OCR, n=368; interferon β -1a, n=347) and PPMS (ORATORIO: OCR, n=347; placebo, n=169) were included. Blood NfL was measured with the Quanterix Advantage kit. Baseline NfL levels were compared between groups using serum samples; longitudinal assessments were conducted using serum from patients with RMS and EDTA plasma from patients with PPMS. Findings were compared to an age-matched cohort of 118 healthy donors (HD) with median (10th to 90th percentile) serum and plasma NfL concentrations of 7.2 (4.2–12.2) pg/mL and 5.9 (3.1–9.4) pg/mL, respectively.

Results: At baseline, median (range) serum NfL levels were 10.6 (2.74–339) pg/mL and 10.8 (2.74–199) pg/mL in patients with RMS and PPMS, respectively. In OCR-treated patients with RMS, median (10th to 90th percentile) serum NfL decreased from 10.8 (5.25–32.5) to 6.7 (3.9–11.5) pg/mL over 96 weeks; in OCR-treated patients with PPMS, plasma NfL decreased from 10.6 (6.0–22.4) to 8.8 (5.4–16.6) pg/mL. Among OCR-treated patients with elevated NfL, the majority (RMS, 93.7%; PPMS, 61.5%) reached levels below the 90th percentile of HD.

Conclusion: Ocrelizumab lowered elevated blood NfL levels in the majority of patients with RMS and PPMS to below the 90th percentile of HD.

Disclosure: Sponsored by Hoffmann-La Roche Ltd; editorial assistance was provided by Health Interactions, USA.

EPR1151

PM2.5 exposure is a risk factor of multiple sclerosis. An ecological study with a Bayesian mapping approach

R.G.E. Bergamaschi¹, L. Trivelli², M.C. Monti², G. Mallucci¹, L. Gerosa¹, E. Pisoni³, C. Montomoli²
¹Multiple Sclerosis Center, IRCCS Mondino Foundation, Pavia, Italy, ²Department of Public Health, Experimental and Forensic Medicine, University of Pavia, Pavia, Italy, ³Joint Research Centre (JRC), European Commission, Ispra, Italy

Background and aims: Some environmental factors have been associated to the increased risk of multiple sclerosis (MS). Air pollution might also play a relevant role. The aim of the study was to investigate the association of the air pollutant particulate matter PM2.5 with MS prevalence in the province of Pavia, which is one of the most polluted area in Europe.

Methods: A total of 927 MS cases (315 M, 612 F) resident in the province of Pavia (547,251 inhabitants) were identified. Spatial emission data regarding PM2.5 were gathered from the European Monitoring and Evaluation Programme database. Gridded data of winter ground-level PM2.5 concentrations subdivided into 188 municipalities were extracted for the period 2010–2017. Municipalities were stratified into 3 groups by tertiles according to PM2.5 concentrations. Ecological regression and Bayesian statistics were used to analyse the association between PM2.5 concentrations, urbanisation degree, deprivation index and MS risk.

Results: The overall MS prevalence in the province of Pavia was 169.4 per 100,000 inhabitants (95% CI: 158.8–180.6). MS risk was significantly higher among those persons living in areas with PM2.5 concentration higher than the European threshold limit (25 microgram/m³). The Bayesian map revealed consistent clusters of MS high risk.

Conclusion: The study found a relationship between MS risk and PM2.5 suggesting that air pollution may be one of the environmental risk factors for MS. The detection of high-risk clusters with an excess number of MS cases encourages analytical studies in those areas to analyse multiple environmental factors related to the different distribution of the MS.

Disclosure: Nothing to disclose

EPR1152

Siponimod in the Central Nervous System (CNS): Translational Evidence on its Penetration and Distribution

M. Bigaud¹, B. Rudolph¹, E. Briard¹, C. Beerli¹, A. Schubart¹, B. Zalc², D. Piani-Meier¹, A. Gardin¹
¹Novartis Pharma AG, Basel, Switzerland, ²Sorbonne Université, Inserm, CNRS, APHP, Institut du Cerveau et de la Moelle épinière (ICM), GH Pitié-Salpêtrière, Paris, France

Background and aims: Mechanism of action of siponimod is believed to involve, at low nM range, both sphingosine 1-phosphate (S1P) receptor subtype-1 (S1P1)-dependent anti-inflammatory effects on pathogenic lymphocytes and glial cells in the CNS, and S1P receptor subtype-5 (S1P5)-dependent pro-myelination effects on oligodendrocytes. This study consolidates translational evidence to establish penetration and distribution of siponimod in the CNS.

Methods: Siponimod CNS penetration/distribution was explored in Xenopus tadpoles, mice, rats, non-human primates (NHPs) and SPMS patients from the EXPAND study (Figure).

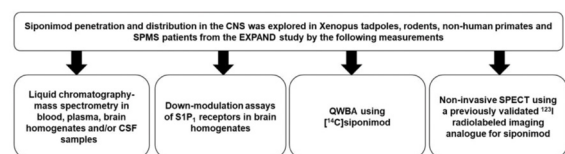

CNS, central nervous system; CSF, cerebrospinal fluid; QWBA, quantitative whole-body autoradiography; S1P, sphingosine-1-phosphate; SPECT, single-photon emission computed tomography; SPMS, secondary progressive multiple sclerosis

Figure. Study Methodology

Results: In tadpoles exposed to siponimod in swimming water, a dose-proportional increase in siponimod levels was obtained in brain homogenates. In mice, 10 days of siponimod-loaded diet produced dose-proportional steady-state blood siponimod levels, concomitant with 6- to 8-fold higher levels in brain-homogenates. Findings were similar in siponimod-treated rats (oral gavage, 7 days). In addition, siponimod cerebrospinal fluid (CSF)/plasma concentration ratio was 0.0025 and S1P1 protein levels in brain-homogenates indicated a dose-dependent down-modulation of brain S1P1 receptors. Quantitative whole-body autoradiography analysis in rats revealed highest siponimod-related radioactivity concentrations in the spinal cord, cerebellum (white matter), choroid plexus, medulla oblongata and corpus callosum. In NHPs, single photon emission computed tomography monitoring revealed siponimod distribution in the CNS with a brain/blood ratio of 6–8 as in mice. Of the EXPAND population (N=1,651), nine patients (five siponimod-treated) consented to CSF sampling at the end of treatment. Siponimod was detected in CSF of all siponimod-treated patients (sub-nM range).

Conclusion: Translational evidence from animal models and SPMS patients suggests penetration and distribution of siponimod in the CNS across species.

Disclosure: This study was funded by Novartis Pharma AG, Basel, Switzerland; a detailed disclosure from each author will be included in the oral/poster presentation. Abstract also submitted to AAN 2020; acceptance pending.

EPR1153

Long-term Follow-Up After Autologous Haematopoietic Stem Cell Transplantation: The Italian Multiple Sclerosis Cohort

G. Boffa¹, M.P. Sormani², A.M. Repice³, M. Capobianco⁴, L. Moiola⁵, M.P. Amato⁶, S. Cottone⁷, J. Frau⁸, G.B. Zimatore⁹, M. Radaelli¹⁰, C. Gasperini¹¹, L.M. Caniatti¹², F. Gualandi¹³, M. Inglese¹, A. Uccelli¹, L. Massacesi³, R. Saccardi¹⁴, G.L. Mancardi¹

¹Department of Neurology, Rehabilitation, Ophthalmology, Genetics, Maternal and Child Health, University of Genoa, Genoa, Italy/IRCCS AOU San Martino-IST, Genoa, Italy, Genoa, Italy, ²Biostatistics Unit, University of Genoa, Genoa, Italy, ³Neurology 2, Careggi University Hospital-University of Florence, Florence, Italy, ⁴AOU San Luigi Gonzaga, Orbassano, Italy, ⁵Department of Neurology, San Raffaele Scientific Institute, Vita-Salute San Raffaele University, Milan, Italy, ⁶Department NEUROFARBA, Section Neurological Sciences, University of Florence, Florence, Italy, ⁷Department of Neurology, Villa Sofia Hospital, Palermo, Italy, ⁸Department of Medical Sciences and Public Health, ⁸Multiple Sclerosis Center Binaghi Hospital, University of Cagliari, Cagliari, Italy, ⁹Operative Unit of Neurology, Dimiccoli General Hospital, Barletta, Italy, Barletta, Italy, ¹⁰Department of Neurology, Papa Giovanni XXIII Hospital, Bergamo, Italy, ¹¹Department of Neuroscience, San Camillo-Forlanini Hospital, Rome, Italy, ¹²Neuroscience and Rehabilitation Department, Ferrara University Hospital, Ferrara, Italy, ¹³Department of Hematology and Bone Marrow Transplant Unit, University of Genova and IRCCS AOU San Martino IST, Genoa, Italy, ¹⁴Cell Therapy and Transfusion Medicine Unit, Careggi University Hospital, Florence, Italy

Background and aims: Despite active treatment, long-term neurological progression is common in multiple sclerosis (MS). Autologous haematopoietic stem cells transplantation (aHSCT) has been extensively explored as a treatment strategy for aggressive MS. However, it's unknown whether aHSCT is able to prevent long-term disability progression.

Aim: To report long-term outcomes of the Italian multi-center experience of the use of aHSCT in MS.

Methods: Retrospective cohort study including aHSCT treated MS patients from 1998 to 2019 in Italy, evaluating long term (i) 3-months confirmed disability progression; (ii) occurrence of relapses; (iii) MRI activity and (iv) treatment-related mortality (TRM).

Results: 206 patients were included in the study. Median (interquartile range) follow-up was 4 (10-2) years (35 and 7 patients had at least 10 and 15 years of follow-up respectively). 69% of patients were free of confirmed neurological progression 10 years after aHSCT. Progressive MS patients had a significantly higher risk of EDSS progression than relapsing-remitting (RR) MS patients (75%vs58%; log-rank p=0.004). 50% of RRMS and 18% of progressive MS patients maintained an EDSS improvement for 5 years. Over 10 years, 71% of patients were free of

relapses and 18%. BEAM+ATG based conditioning regimen was associated with a reduced risk of relapses (24% vs 82%; log rank test $p < 0.0001$) compared with Cy+ATG and Thiohepa+Cy based conditioning regimens. TRM was 1.5% in the entire cohort [mean time(SD)=41.3 (25) days after transplant]. No deaths occurred after 2007.

Conclusion: In most patients, aHSCT is able to prevent disability progression for up to 20 years. RRMS patients are those who benefit the most from aHSCT.

Disclosure: Nothing to disclose

EPR1154

Cognitive Dysfunction in Treatment-naïve Patients with Multiple Sclerosis

N. Botchorishvili¹, A. Dzagnidze¹, N. Mikava², N. Mikeladze², M. Tighashvili², M. Janelidze¹

¹Department of Clinical Neurology, Tbilisi State Medical University, Tbilisi, Georgia, ²Clinical Neurology, S. Khechinashvili University hospital, Tbilisi, Georgia

Introduction: Cognitive dysfunction is a common feature of Multiple sclerosis (MS). Studies have shown that 50-70% of patients with MS are unemployed after 10 years of disease onset. It is considered that one of the main reasons for early retirement is cognitive impairment. There is increasing evidence that disease-modifying therapy (DMT) has a positive effect on cognitive function in MS patients.

Aim: The study aimed to identify the prevalence and features of cognitive dysfunction in patients with multiple sclerosis who never received disease-modifying therapy.

Methods: 54 patients with a diagnosis of MS based on the 2017 McDonald criteria were included in the study. All patients underwent neuropsychological evaluation with Brief International Cognitive Assessment for MS battery (BICAMS) and Montreal Cognitive Assessment (MoCA). Demographics, Medical history details and Expanded Disability Status Scale (EDSS) scores were recorded. 32 patients in the study population were treated with immunomodulatory drugs. 22 patients never received DMT (8 out of them had disease duration of one year).

Results: Patients with treatment naïve multiple sclerosis performed worse on MoCA, California Verbal Learning Test II (CVLT-II) and Symbol Digit Modality Test (SDMT). They obtained significantly lower scores on SDMT.

	Patients receiving DMT n 32	Treatment-naïve patients n 22
Age, y	40 ± 9.4 (24-57)	40.6 ± 11.6 (25-65)
Women/men	23/9	17/5
Disease duration, y	8 ± 4.6 (2-22)	5.3 ± 5 (1-17)
RRMS	24 (75%)	16 (73%)
SPMS	8 (25%)	2 (9%)
PPMS	-	4 (18%)
Education	13.7 ± 4.2	14.7 ± 2.0
EDSS	3.1 ± 1.6 (1.5-6.5)	3.4 ± 1.4 (1.5-7.0)
SDMT	40 ± 12.3 (16-68)	29 ± 8.9 (5-44)
CVLT	53 ± 11.3 (30-76)	49 ± 8.4 (32-65)
BVMT-R	21 ± 7.1 (6-31)	22 ± 6.8 (6-36)
MoCA	23.4 ± 2.9 (17-28)	22.3 ± 3.8 (12-27)

Table 1. Difference in means for all measure

Conclusion: Our study demonstrates that disease-modifying therapy has a definite beneficial effect on cognitive function of patients with multiple sclerosis.

Disclosure: Nothing to disclose

EPR1155

Rationale, design and feasibility assessment of the Phase IV CLASSIC-MS study evaluating long-term efficacy for patients with multiple sclerosis treated with cladribine tablets

A.N. Boyko¹, J.D. Correale², G. Edan³, M. Freedman⁴, G. Giovannoni⁵, X. Montalban⁶, K. Rammohan⁷, T. Leist⁸, D. Stefoski⁹, B. Yamout¹⁰, B. Garcia-Alonso¹¹, A. Aydemir¹², E. Verdun Di Cantogno¹¹

¹Pirogov Russian National Research Medical University, Moscow, Russian Federation, ²FLENI Institute, Buenos Aires, Argentina, ³Department of Neurology, University Hospital of Rennes, Rennes, France, ⁴University of Ottawa and the Ottawa Hospital Research Institute, Ottawa, Canada, ⁵Queen Mary University of London, Blizard Institute, Barts and The London School of Medicine and Dentistry, London, United Kingdom, ⁶St. Michael's Hospital, University of Toronto, Toronto, Ontario, Canada, ⁷Department of Neurology, MS Research Center, University of Miami School of Medicine, Miami, FL, USA, ⁸Division of Clinical Neuroimmunology, Jefferson University, Comprehensive MS Center, Philadelphia, USA, ⁹Department of Neurological Sciences, Rush Medical College, Chicago, USA, ¹⁰American University of Beirut Medical Center, Beirut, Lebanon, ¹¹Merck KGaA, Darmstadt, Germany, ¹²EMD Serono Research & Development Institute Inc., Billerica, USA

Background and aims: Cladribine tablets 10mg (CT; cumulative dose 3.5mg/kg over 2 years) demonstrated efficacy versus placebo over 2 years in CLARITY, CLARITY Extension and ORACLE-MS, showing sustained efficacy without further active treatment in CLARITY Extension. CLASSIC-MS will explore long-term efficacy and real-world treatment patterns in these trial patients. Long-term safety in this population has been assessed in the PREMIERE registry.

Methods: CLASSIC-MS is an exploratory, low-interventional, multicentre, ambispective, Phase IV study of patients with MS, or those with a 1st clinical demyelinating event enrolled into the Phase III trials and who received ≥ 1 course of CT or placebo (N=1946). Following pre-baseline screening and assessment for eligibility, long-term retrospective data will be obtained from medical records at Study Visit 1; prospective data collected at Study Visits 1 and 2 (Figure 1). Patients will be enrolled for 17 months (Q3 2019-Q4 2020). Last Patient Last Visit is expected in Q1 2021. Primary objective: evaluation of long-term mobility after treatment with CT or placebo. Table 1 lists primary, secondary and tertiary key objectives.

Figure 1. CLASSIC-MS study design

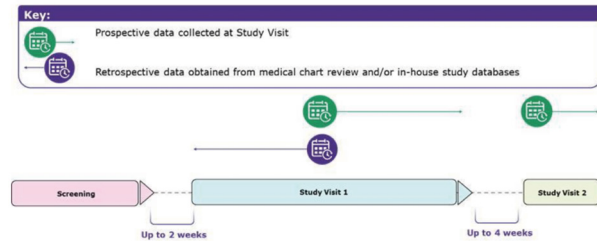

Table 1. Key exploratory objectives in CLASSIC-MS

Primary	Evaluation of long-term mobility
Secondary	Differences in clinical and MRI characteristics between long-term responders [†] and non-responders Real world treatment patterns Durability of clinical outcomes, quality of life and cognitive outcomes after treatment with IMP
Tertiary	Durability of outcome on brain imaging after treatment with IMP High-disease activity influencing long-term response Differences in genetics between long-term responders [†] and study participants who are not
[†] Study participants who did not demonstrate any evidence of disease reactivation based on Investigator assessment of clinical and imaging outcomes until Year 4 or later following their last dose of IMP and who did not receive disease modifying treatment until Year 4 or later following their last dose of IMP IMP, investigational medicinal product (cladribine tablets or placebo)	

Results: In 2018, a second feasibility survey was sent to 225 centres; 110 centres provided positive responses and were included, representing 48% of sites originally enrolled in the Phase III studies. In total 115 centres were not included (81 were not willing to participate; 13 were dropped; 16 were non-responders; 5 were rejected).

Conclusion: CLASSIC-MS will provide valuable information on the long-term efficacy of patients with MS treated with CT.

Disclosure: This study was sponsored by EMD Serono Inc, a business of Merck KGaA, Darmstadt, Germany (in the USA), and Merck Serono SA, Geneva, an affiliate of Merck KGaA Darmstadt, Germany (ROW). The authors and Merck acknowledge the involvement of Kristin Gabriel for their role in study design, data interpretation and publication concept.

MS and related disorders 2

EPR1156

Fingolimod and dimethyl-fumarate derived lymphopenia is not associated with short-term treatment response and risk of infections in a real-life MS population

N. Bruschi¹, G. Boffa¹, M. Cellerino¹, C. Lapucci¹, G. Novi¹, E. Sbragia¹, E. Capello², A. Uccelli¹, M. Inglese¹

¹Department of Neuroscience, Rehabilitation, Ophthalmology, Genetics, Maternal and Child Health, University of Genova and IRCCS AOU San Martino IST, Genoa, Italy, ²Ospedale Policlinico San Martino IRCCS, Genoa, Italy

Background and aims: The association between treatment related lymphopenia in multiple sclerosis (MS), drug efficacy and risk of infections is not yet fully understood. To assess whether lymphopenia is associated with short-term treatment response and infections rate in a real-life MS population treated with Fingolimod (FTY) and Dimethyl-fumarate (DMF).

Methods: We analyzed the associations between absolute lymphocyte count (ALC) at baseline, 6 and 12 months and mean percentage decrease (MPD) at 6 and 12 months with treatment response and the occurrence of infections over a 12 months period.

Results: 137 and 75 patients treated with FTY and DMF respectively were included. FTY patients had lower ALC and higher MPD (63.5%) at 12 months ($p < 0.001$, $\chi^2=94$; $p < 0.001$, $U=540$). Higher number of previous therapies and lower baseline ALC were predictors of lymphopenia at 6 months ($p=0.047$, $OR=1.60$ and $p=0.014$, $OR=1.1$) and 12 months ($p=0.003$, $OR=1.97$ and $p=0.023$, $OR=1.1$). In FTY patients only, female sex and higher EDSS were predictors of lymphopenia at 12 months ($p=0.006$, $OR=7.58$ and $p=0.03$, $OR=1.56$). No significant changes in mean ALC, MPD at 6 and 12 months were found between patients with and without disease control and in those experiencing infections in both treatment groups.

Conclusion: Peripheral blood lymphocytes changes are not associated with short-term treatment response and with the rate of infections during FTY and DMF treatment in real-world patients. Careful monitoring of infectious adverse events is required even in the absence of lymphopenia.

Disclosure: Nothing to disclose

EPR1157

Artificial Intelligence on Conventional Magnetic Resonance Images for the Diagnosis of Neuromyelitis Optica Spectrum Disorders

L. Cacciaguerra¹, L. Storelli², Š. Mesaroš³, M. Radaelli⁴, J. Palace⁵, I. Dujmović-Bašuroski³, L. Matthews⁵, J. Drulovic³, M.I.S. Leite⁵, M. Filippi¹, M.A. Rocca¹
¹Neuroimaging Research Unit, Institute of Experimental Neurology, Division of Neuroscience; and Neurology Unit, IRCCS San Raffaele Scientific Institute, Milan, Italy, ²Neuroimaging Research Unit, Institute of Experimental Neurology, Division of Neuroscience, IRCCS San Raffaele Scientific Institute, Milan, Italy, ³Clinic of Neurology, Faculty of Medicine, University of Belgrade, Belgrade, Serbia, ⁴Neurology Unit, IRCCS San Raffaele Scientific Institute, Milan, Italy, ⁵Nuffield Department of Clinical Neurosciences, University of Oxford, Oxford, United Kingdom

Background and aims: Diagnostic criteria of neuromyelitis optica spectrum disorders (NMOSD) exclude seronegative patients suffering limited forms of the disease, as they are usually considered prodromal phases of multiple sclerosis (MS). Using MRI data, a great effort is ongoing to allow an automatic and reliable diagnosis of MS-mimicking diseases. Deep-learning-based imaging diagnostics could go beyond conventional MRI and clinical evaluation and contribute to provide objective data-driven classification of these patients.

Methods: The model structure was based on 4 consecutive 3D convolutional neural network layers, followed by a fully dense layer after the extraction of features and was trained on conventional brain T2- and T1-weighted MRI scans from seropositive NMOSD patients ($n=55$) and early MS patients ($n=65$). After validation on an independent set of 30 NMOSD and 30 MS, the final algorithm was applied to a group of seronegative patients ($n=46$) to evaluate their classification as NMOSD or MS with deep-learning-based diagnostics.

Results: In the validation sample, the final algorithm showed a classification accuracy of 0.98. Of seronegative patients, 17 were recurrent myelitis (36.9%), 17 recurrent optic neuritis (RON, 36.9%) and 12 NMOSD (26.2%). In this dataset, the deep-learning algorithm classified 45/46 (97.8%) patients as NMOSD. The patient classified as MS was a Caucasian female with RON (disease duration 4.5 years), without oligoclonal bands in the cerebrospinal fluid.

Conclusion: Deep-learning evaluation suggests that a large majority of seronegative patients is likely to belong to the NMOSD spectrum. A longitudinal evaluation is required to confirm the diagnostic accuracy of this approach.

Disclosure: Nothing to disclose

EPR1158

Durvalumab and Multiple Sclerosis: a causal link or simple unmasking?

F. Caputo, A. Manni, B. Orlando, M. La Cava, T. Guerra, M. Narracci, P. Iaffaldano, D. Paolicelli, M. Trojano
Bari, Italy

Background and aims: Immune checkpoint inhibitors (ICIs) treatment is revolutionizing the immune-oncology therapy. Durvalumab is a monoclonal antibody blocking programmed cell death ligand-1 (PDL-1). Its toxicity on Central Nervous System (CNS) is not well established and its impact on demyelinating diseases is not clear.

Methods: A Caucasian 46-year-old man was diagnosed with lung adenocarcinoma in 2018 for which he was treated with Durvalumab 120mg endovenously following chemoradiotherapy. After 10 infusions, restaging whole-body computed tomography showed a right peritrigonal contrast enhancing (CE+) lesion, and brain magnetic resonance imaging (MRI) revealed other sovratentorial white matter lesions. Durvalumab was discontinued and the patient received a standard course of methylprednisolone with reduction of CE+. Therefore, he was admitted to our Neurology Department to rule out a demyelinating disorder. Brief fluctuating episodes of paraesthesia of right limbs were reported since 2013. All clinical and laboratory tests were normal, but the cerebrospinal fluid analysis showed twenty-three oligoclonal bands.

Results: Therefore, a diagnosis of Multiple Sclerosis (MS) was made according to 2017 Mc Donald criteria and treatment with glatiramer acetate was started.

Conclusion: This case report indicates that PDL-1 is an immunological checkpoint triggering MRI brain activity in a patient previously not diagnosed with MS. ICIs can exacerbate or unmask demyelinating diseases but it is unknown if they can be responsible of de novo inflammatory demyelinating pathology. It is hypothesized that epitope spreading and a broader T-cell response determined by ICIs may cause demyelinating events. It is crucial to be aware of the role of the new biodrugs in neurological inflammatory disease.

Disclosure: Nothing to disclose

EPR1159

Brainstem monoaminergic functional and structural connectivity is altered in multiple sclerosis and associated to cognitive fatigue

T. Carandini¹, M. Mancini², I. Bogdan³, C. Rae¹, A. Barritt¹, A. Sethi⁴, N. Harrison⁵, W. Rashid¹, M. Bozzali⁶, M. Cercignani⁶

¹Department of Neuroscience, Brighton and Sussex Medical School, University of Sussex, UK, Brighton, United Kingdom, ²NeuroPoly Lab, Polytechnique Montreal, Montreal, Canada, ³Haywards Heath, United Kingdom, ⁴Psychiatry, Psychology & Neuroscience, King's College London, London, United Kingdom, ⁵Department of Psychology and Department of Medicine, University of Cardiff, Cardiff, United Kingdom, ⁶Neuroscience, University of Sussex, Brighton, United Kingdom

Background and aims: Monoamines play a role in multiple sclerosis (MS) pathogenesis and alterations in monoaminergic pathways have been linked to fatigue [1]. We evaluated brainstem monoaminergic nuclei (BrMn) functional (Fc) and structural (Sc) connectivity in a group of MS patients and controls, and assessed possible associations with fatigue.

Methods: 68 relapsing-remitting-MS patients and 39 controls underwent brain-MRI. BrMn Fc with the rest of the brain was evaluated by resting-state-functional-MRI[2], while Sc was investigated by fixel-based-analysis and compared by means of fibre-density/cross-section[3] in the 2 groups. Selected tracts of interest projecting from BrMn were derived from Fc analyses. Correlations of Fc/Sc with fatigue status were evaluated in MS.

Results: Controls displayed positive Fc between dopaminergic-BrMn and the default-mode network (DMN), serotonergic-BrMn and both DMN and cerebellar cortex, noradrenergic-BrMn and the executive control network. BrMn Fc with these functional networks was reduced in MS, as compared to controls. Fixel-based-analysis displayed structural disconnection between BrMn and cortical targets in MS patients, due to white matter (WM) abnormalities. Correlations between cognitive fatigue and structural integrity within the mesocorticolimbic tracts were found in MS, as well as within the noradrenergic-prefrontal cortex projections.

Conclusion: Our study revealed functional disconnections between BrMn and crucial brain networks in MS, that can be – at least partially – explained by structural alterations in the WM tracts projecting from BrMn, and support the hypothesis of a contribution of monoaminergic systems to cognitive fatigue in MS. These findings add new information about the role of monoaminergic systems in MS pathogenesis and suggest new therapeutic targets.

Disclosure: Nothing to disclose

EPR1160

Safety, Patient Reported Outcomes, and Clinical Assessment on Walking Ability of Prolonged-Release Fampridine Treatment in Routine Clinical Practice: Results of the LIBERATE Study

G. Castelnovo¹, R. Hupperts², M.S. Freedman³, A. Bergmann⁴, V. Sinay⁵, T.C. Triviño⁶, G. Kong⁷, T. Koster⁸, H. Williams⁷, B. Zhu⁷, J. Killestein⁹
¹Service de Neurologie CHU Caremeau, Nîmes, France, ²Maastricht University Medical Center, Sittard, Netherlands, ³University of Ottawa and the Ottawa Hospital Research Institute, Ottawa, Canada, ⁴NeuroTransData GmbH, Neuburg an der Donau, Germany, ⁵Fundacion Favaloro/ INECO, Ciudad De Buenos Aires, Argentina, ⁶Donostia University Hospital, San Sebastian, Spain, ⁷Biogen, Cambridge, USA, ⁸Biogen, Utrecht, Netherlands, ⁹MS Center Amsterdam, Amsterdam, Netherlands

Background and aims: Prolonged-release fampridine (PR-FAM) 10mg tablet twice-daily is the only approved treatment in the world for improvement of walking ability in adults with multiple sclerosis (MS) with walking disability (EDSS 4-7). LIBERATE, a post-authorization, prospective, multicenter, observational study, assessed the safety and effectiveness of PR-FAM in the real-world setting.

Methods: LIBERATE recruited MS patients newly prescribed PR-FAM at 201 sites in 13 countries. Demographic/safety data were collected at enrolment through 12 months. Multiple Sclerosis Impact Scale-29 (MSIS-29) and physician-rated Clinical Global Impression of Improvement (CGI-I) scores for walking ability, were assessed.

Results: The safety analysis included 4646 patients with 3534.8 patient-years of exposure. Median (range) age was 52.6 (21–85) years, 65.7% were female; 24.9% (n=1158) of patients discontinued treatment due to lack of efficacy. Treatment-emergent AEs (TEAEs) were reported in 52.7% of patients, and serious TEAEs in 6.0%. TEAEs of special interest occurred in 38.7%, and serious TEAEs of special interest in 2.8% (Table 1). MSIS-29 physical impact score improved significantly for patients on-treatment for 12 months vs those who discontinued (mean change from baseline to 12 months: 9.99 vs -0.34 points; p<0.001). Results were similar for MSIS-29 psychological impact. At 12 months, a greater proportion of patients on treatment had improvement in CGI-I for walking ability vs those who discontinued (61% vs 11%; p<0.001).

Table 1. Overall Adverse Events and Adverse Events of Special Interest

Preferred Term	European Countries (N = 4439)	Non-European Countries (N = 207)	Total (N = 4646)
Any TEAE, n (%)	2407 (54.2)	41 (19.8)	2448 (52.7)
Serious TEAEs, n (%)	277 (6.2)	2 (1.0)	279 (6.0)
TEAEs of special interest, n (%)	1767 (39.8)	32 (15.5)	1799 (38.7)
Serious TEAEs of special interest, n (%)	127 (2.9)	1 (0.5)	128 (2.8)
Seizure-related TEAEs, n (%)	17 (0.4)	0 (0.0)	17 (0.4)
Incidence rate/ 100 person-years (95% CI)	0.5 (0.3, 0.8)	0 (0.0)	0.5 (0.3, 0.8)
Serious hypersensitivity-related TEAEs, n (%)	1 (<0.1)	0 (0.0)	1 (<0.1)
Incidence rate/ 100 person-years (95% CI)	<0.1 (0, 0.2)	0 (0.0)	<0.1 (0, 0.2)
Urinary tract infection-related TEAEs, n (%)	399 (9.0)	7 (3.4)	406 (8.7)
Incidence rate/ 100 person-years (95% CI)	14.9 (13.6, 16.3)	5.5 (2.4, 10.8)	14.5 (13.3, 15.8)
Severe infections other than UTI-related TEAEs, n (%)	148 (3.3)	0 (0.0)	148 (3.2)
Incidence rate/ 100 person-years (95% CI)	5.1 (4.4, 6.0)	0 (0.0)	4.9 (4.2, 5.7)
Depression and suicide-related TEAEs, n (%)	59 (1.3)	0 (0.0)	59 (1.3)
Incidence rate/ 100 person-years (95% CI)	1.8 (1.4, 2.3)	0 (0.0)	1.7 (1.3, 2.2)
Anxiety-related TEAEs, n (%)	68 (1.5)	1 (0.5)	69 (1.5)
Incidence rate/ 100 person-years (95% CI)	2.1 (1.6, 2.6)	0.7 (0, 3.8)	2.0 (1.6, 2.5)
TEAEs suggestive of central nervous system stimulation related TEAEs, n (%)	1382 (31.1)	26 (12.6)	1408 (30.3)
Incidence rate/ 100 person-years (95% CI)	58.3 (55.7, 60.9)	20.6 (13.9, 29.4)	56.7 (54.3, 59.3)
Cardiovascular-related TEAEs, n (%)	80 (1.8)	1 (0.5)	81 (1.7)
Incidence rate/ 100 person-years (95% CI)	2.5 (2.0, 3.1)	0.7 (0, 3.8)	2.5 (2.0, 3.0)
Clinically significant haematological abnormality-related TEAEs, n (%)	26 (0.6)	0 (0.0)	26 (0.6)
Incidence rate/ 100 person-years (95% CI)	1.1 (0.7, 1.5)	0 (0.0)	1.0 (0.7, 1.4)

AE = adverse event; N = number of patients overall; n = number of patients in a category; TEAE = treatment-emergent adverse event; CI = confidence interval.
 Note: Percentages are calculated using the total number of patients (N) as the denominator.
 All recorded AE verbatim terms were coded using MedDRA version 18.1.
 TEAE is defined as any AE with an onset date that is on or after the first dose of Fampridine and within 28 days after the last dose or any pre-existing condition that has worsened in severity after the first dose of Fampridine. For overall AE in the study, the period is relative from the first dose of treatment and within 28 days after the last dose in the extension study.
 TEAEs of special interest in this study were those related to seizure, hypersensitivity reactions, urinary tract infections (UTI) and urinary symptoms, depression and suicide attempt, cardiovascular disorders, severe infections other than UTI, anxiety, central nervous system stimulation, and clinically significant haematological abnormalities.

Table 1. Overall Adverse Events and Adverse Events of Special Interest

Conclusion: MSIS-29 and CGI-I scores after long-term PR-FAM treatment show clinical benefits consistent with those previously reported. No new safety signals were identified in this real-world study suggesting that routine risk minimization measures are effective.

Support: Biogen

Disclosure: Supported by Biogen

EPR1161

Relationship between retinal layers' thickness and disability worsening in relapsing and progressive multiple sclerosis

M. Cellerino¹, L. Priano¹, N. Bruschi¹, G. Boffa¹, M. Petracca², C. Lapucci¹, G. Novi¹, E. Sbragia¹, E. Capello¹, A. Uccelli³, M. Inglese³
¹of Neuroscience, Rehabilitation, Ophthalmology, Genetics, Maternal and Child Health, University of Genoa, Genoa, Italy, ²Neurology, Icahn School of Medicine at Mount Sinai, New York, USA, ³Department of Neurosciences, Rehabilitation, Ophthalmology, Genetics, Maternal and Child Health (DINOEMI), University of Genoa and IRCCS Policlinico San Martino, Genoa, Genova, Italy

Background and aims: Data regarding the predictive value of macula-derived measures are lacking, especially in progressive-MS (PMS). We aimed at investigating whether a single optical coherence tomography (OCT) assessment including automated intra-retinal layer segmentation can predict risk of disability worsening in both relapsing-remitting-MS (RRMS) and PMS.

Methods: Baseline thickness of macula-derived measures was assessed in 180 patients (101 RRMS and 79 PMS, Table 1) who underwent Spectral-Domain-OCT. All patients had at least 1 Expanded Disability Status Scale (EDSS) measurement during the subsequent follow-up (FU). Differences in terms of OCT metrics and their association with FU-disability were assessed by ANCOVA and linear regression models, respectively.

	RRMS (n=101)	PMS (n=79)	p-values*
Demographics			
PPMS, no (%)	-	61 (77%)	-
Age, mean (SD), y	39 (10.3)	49 (10.7)	<0.0001
Female, no (%)	75 (74%)	37 (47%)	<0.0001
Disease duration, mean (SD), y	8.4 (6.5)	11.8 (8.1)	0.002
EDSS score at baseline, median (range)	2 (0-6)	5 (1.5-7.5)	<0.0001
EDSS score at follow-up, median (range)	2.5 (0-6)	5.5 (1.5-8)	<0.0001
OCT metrics			
pRNFL, mean (SD)	96.2 (13.7)	90.7 (12.1)	0.02
narRNFL, mean (SD)	19.3 (1.9)	19.8 (3.1)	n.s.
GCIPL, mean (SD)	81.1 (10.4)	76.5 (12.1)	0.003
INL, mean (SD)	37.2 (3.4)	37.5 (3.6)	n.s.
OPL, mean (SD)	33.3 (5.3)	34.1 (4.3)	n.s.
ONL, mean (SD)	73.8 (15.2)	72.6 (8.5)	n.s.

Table 1

Results: Mean FU was 2 years (range 1-5.5). Baseline pRNFL and GCIPL were thinner in PMS compared to RRMS (p=0.02 and p=0.003, respectively; Table 1). Multivariable models showed that GCIPL was significantly associated with subsequent disability (0.04 increase in EDSS for each 1-µm decrease in GCIPL, 95% CI: 0.006-0.08; p=0.02; Figure 1) in RRMS. Baseline GCIPL was thinner in patients with FU-EDSS >4 compared to those with FU-EDSS ≤4, and individuals in the highest baseline

GCIPL tertile had a significantly lower FU-EDSS score compared to those in the middle and lowest tertile (p=0.01 and p=0.001, respectively). These findings were confirmed in analyses restricted to RRMS but not PMS patients.

Fig. 1: Association between baseline GCIPL thickness and EDSS score at the end of follow-up period in RRMS and PMS patients

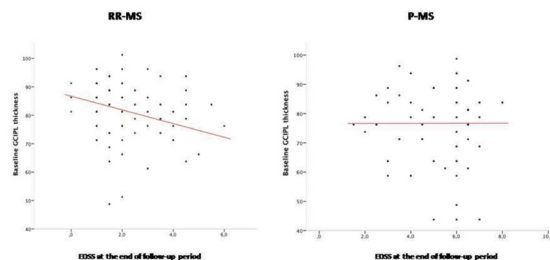

Figure 1

Conclusion: Among OCT-derived metrics, GCIPL thickness had the strongest association with short-medium term disability. However, such association was statistically significant only in RRMS patients. Future studies will have to investigate GCIPL predictive value in the longer term, especially in PMS patients.

Disclosure: Nothing to disclose

EPR1162

Multiple sclerosis fatigue and energy metabolites- Hints from Phosphorus Magnetic Resonance Spectroscopy

P. Kauv¹, M.A. Chalah², A. Créange³, J.-P. Lefaucheur², J. Hodel¹, S.S. Ayache²

¹Service de Neuroradiologie, Hôpital Henri-Mondor, EA 4391, Excitabilité Nerveuse et Thérapeutique, Université Paris-Est-Créteil, Créteil, France, ²Service de Physiologie-Explorations Fonctionnelles, Hôpital Henri-Mondor, EA 4391, Excitabilité Nerveuse et Thérapeutique, Université Paris-Est-Créteil, Créteil, France, ³Service de Neurologie, Hôpital Henri-Mondor, AP-HP, EA 4391, Excitabilité Nerveuse et Thérapeutique, Université Paris-Est-Créteil, Créteil, France

Background and aims: Fatigue related to multiple sclerosis (MS) is usually perceived as 1 of the most annoying complaints. Hints towards its underlying mechanisms could be provided by various magnetic resonance (MRI) modalities including conventional MRI and phosphorous magnetic resonance spectroscopy (31P-MRS). The latter could offer valuable knowledge regarding the energetic status of different brain areas. Thus, the aim of this work was to assess the relationship that would exist between energetic metabolites and fatigue scores.

Methods: 30 patients suffering from progressive MS were recruited. Sociodemographic and clinical data were collected. Fatigue was assessed using Fatigue Severity Scale (FSS). 31P-MRS spectrum was obtained from two regions: (i) bilateral frontoparietal area and (ii) normal appearing white matter (NAWM) of the centrum semiovale. Percentages of PCr and β -ATP (β -ATP%) were calculated.

Results: Direct correlation was found between FSS scores and frontoparietal β -ATP% ($p < 0.05$). No correlation was found between FSS and NAWM energy metabolites, or between FSS and clinical and sociodemographic data.

Conclusion: These data hint towards a link between the accumulation of ATP metabolites and the exacerbation of fatigue. In fact, an energy relationship seems to exist between glial cells and neurons in a way that astrocytes are considered the production cells of ATP that is essential for neuronal depolarization and action potential propagation. In MS, the extent of axonal degeneration would lead to a decrease in ATP utilization and an accumulation of its metabolites (i.e., β -ATP). This may aggravate fatigue perception.

Disclosure: This research received no specific grant from any funding agency in the public, commercial, or not-for-profit sectors. AC gave expert testimony for CSL Behring, Novartis, received grants from Biogen, Novartis, CSL Behring, GE Neuro, Octapharma, and gave lectures for Genzyme. SSA declares having received travel grants or compensation from Genzyme, Biogen, Novartis and Roche. The remaining authors declare no conflict of interest.

EPR1163

Multiple sclerosis incidence and prevalence in Ukraine over the last two decades

M.Y. Chernenko, N.P. Voloshyna, O.V. Pisotska, O.Y. Kutikov, I.M. Nikishkova, D.O. Kutikov
Institute of Neurology, Psychiatry and Narcology of the NAMS of Ukraine, Kharkiv, Ukraine

Background and aims: Multiple sclerosis (MS) epidemiological trends are a matter of a special attention due to a growing significance of this disease, so the aim was to reveal such trends in Ukraine.

Methods: Data of the official general and public health statistics on regions of Ukraine since 2000 were examined and used for the calculations.

Results: In 2000, the MS prevalence in Ukraine was 35.63 cases per 100,000 (middle-risk area) (Figure 1), but 5 regions were in a MS high-risk area (50-100 cases per 100,000) (Figure 2A). Ten years later, MS prevalence in Ukraine has grown to 42.29 per 100,000 and 19 (70.1%) regions of 27 ones were in the MS high-risk area (Figure 2B). In 2017, overall MS prevalence in Ukraine approached to a high-risk threshold (49.16 per 100,000). During the last two decades in Ukraine, with an average MS incidence of 2.60 ± 0.18 cases per 100,000, there is an upward trend in MS prevalence for Western and Central regions (Figure 2C). Medical check-up had risen from 83.9% to 92.0% in this period.

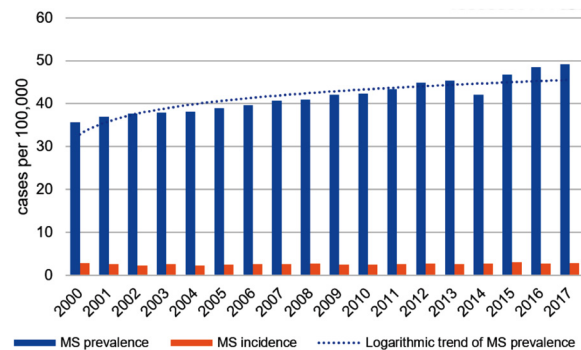

Figure 1. MS prevalence and incidence in Ukraine by year

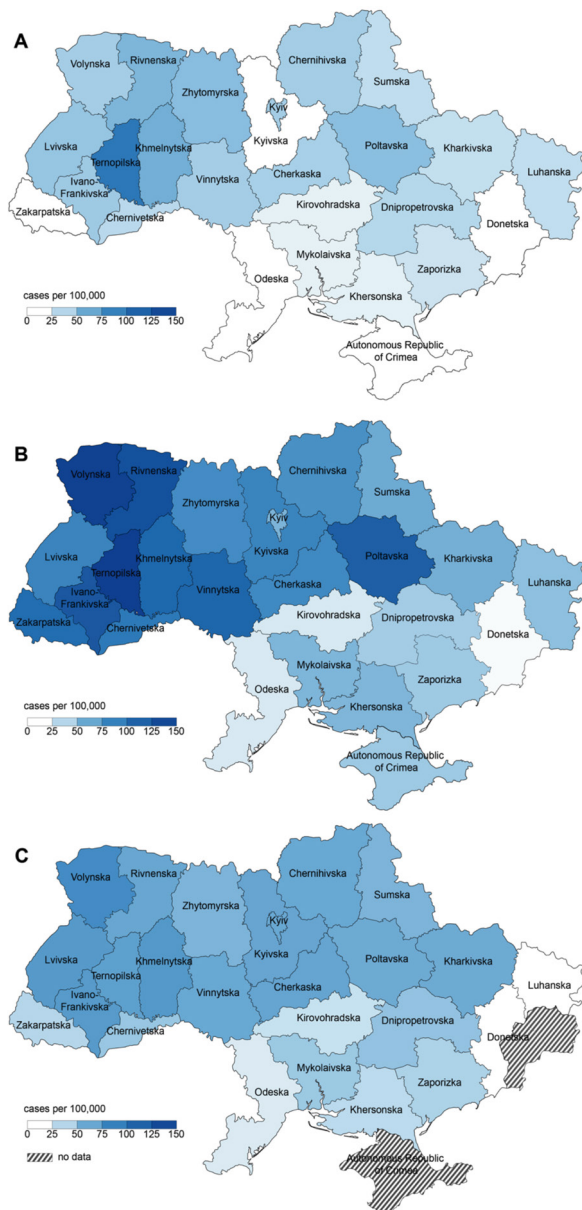

Figure 2. MS prevalence in regions of Ukraine: (A) in 2000; (B) in 2010; (C) in 2017

Conclusion: An increasing of MS prevalence and incidence in 2000-2010 was partly due to improvement of diagnostic tools and physicians' vigilance concerning MS diagnosis. A slower-than-expected according to MS incidence growth of MS prevalence in Ukraine resulted from migration processes first of all. It should be taking into account also that the statistical data since 2014 were under influence of a number of factors not related to MS, particularly sociopolitical ones.

Disclosure: Nothing to disclose

EPR1164

Serum Neurofilaments Light Chains Predict Visual Recovery and Neuroaxonal Degeneration After Acute Optic Neuritis

G. Dalla Costa¹, M. Pisa¹, S. Guerrieri¹, C. Zanetta¹, L. Moiola¹, V. Martinelli¹, G. Comi¹, R. Furlan¹, L. Leocani²

¹Institute of Experimental Neurology, San Raffaele Hospital, Milan, Italy, ²Institute of Experimental Neurology (INSPE) - University Vita Salute San Raffaele, IRCCS-San Raffaele Hospital; Milan, Italy

Background and aims: Neuroaxonal degeneration after optic neuritis (ON) can be measured with Optical Coherence Tomography (OCT). Although the visual prognosis of typical optic neuritis is generally favourable, the degree of visual recovery and neurodegeneration associated with a single episode varies considerably. Neurofilament light chain (NfL) is part of the axonal cytoskeletal neurofilaments and is released upon immune-mediated axonal damage, such as multiple sclerosis (MS) relapses. We explored the usefulness of NfL levels at ON onset in predicting neuroretinal degeneration and visual outcome.

Methods: 31 patients (mean age 37.3 years, SD 8.7, 71% females) with an acute optic neuritis between October 2014 and August 2017 underwent serum NfL dosing at baseline (Simoa HD-1; Quanterix) and high- and low-contrast visual acuity and OCT at baseline and after a mean follow-up of 27.6 ± 12.3 months. Changes in inter-ocular difference in visual acuity and RNFL peripapillary thickness were measured, and multilevel mixed effect models were used to assess the prognostic factor of baseline NfL levels.

Results: At follow-up, inter-ocular visual acuity difference improved ($2.8/10 \pm 1.2$) with respect to baseline ($2.1/10 \pm 1.5$, $p < 0.05$), while inter-ocular RNFL thickness difference worsened (3.2 ± 10.2 vs 12.7 ± 15.2 microns). Baseline NfL levels above 75 percentile were significantly associated with worse inter-ocular visual acuity (B 0.05 SE 0.02, $p < 0.01$) and inter-ocular RNFL thickness difference at follow-up (B 0.64 SE 0.20, $p < 0.01$).

Conclusion: Serum NfL light chain could be a promising biomarker for prediction of visual outcome after ON and for the implementation of neuroprotective or regenerative strategies.

Disclosure: Part of this study was supported by a Merck research grant to L. Leocani. R.Furlan e L.Leocani: equal contribution

EPR1165

Early clinical and MRI predictors of long-term disability in pediatric onset multiple sclerosis patients: a 10 year longitudinal study

E. De Meo, L. Moiola, R. Bonacchi, G. Dalla Costa, F. Sangalli, G. Comi, B. Colombo, V. Martinelli, M. Filippi
Milan, Italy

Background and aims: The main clinical and MRI features driving clinician choices are not as clear for pediatric onset multiple sclerosis patients (POMS) as for adult ones. We aimed at assessing early predictors of long-term clinically-relevant outcomes in a large cohort of POMS.

Methods: A cohort of POMS (n=135) was retrospectively analyzed. Clinical and MRI assessment was obtained at disease onset and after 1, 2 and 3 years. The longest clinical follow-up (mean 9.33±6.45 years) was considered for clinically-relevant outcomes. Cox models were used to assess predictors of time to 1st relapse, while multivariable logistic and linear regression models identified clinical and MRI predictors of long-term outcomes. Disease-modifying treatments were not considered, since the reverse causation involved in selecting patients for treatment.

Results: Across baseline features, optic nerve involvement predicted shorter time to first relapse (HR=2.31, p=0.02). Baseline Expanded Disability Status Scale (EDSS) scores (β =3.42, p<0.001) and presence of brainstem lesions (β =2.24, p=0.01) were significantly associated with long-term EDSS. The detection of at least 2 new lesions at year-1 (OR=27.53, p=0.002) or at year-2 (OR=9.70, p=0.04) and EDSS changes (year-1: OR=22.84; year-2: OR=62.31; year-3: OR=2.02; p<0.001) were associated with long-term EDSS worsening. EDSS changes (year-1: β =2.88; year-2: β =5.30; year-3: β =3.62; p<0.001) were also associated with long-term EDSS score.

Conclusion: In POMS, baseline optic nerve involvement suggested a more active disease, while baseline brainstem involvement predicted worse prognosis. Accurate clinical and MRI monitoring during the 1st 2 years of disease might be a powerful tool for counselling patients about long-term prognosis, and personalizing treatment plans.

Disclosure: Nothing to disclose

EPR1166

Towards personalized medicine: assessing early predictors of treatment response in pediatric MS patients.

E. De Meo, L. Moiola, R. Bonacchi, G. Dalla Costa, F. Sangalli, G. Comi, B. Colombo, V. Martinelli, M. Filippi
Milan, Italy

Background and aims: No evidence of disease activity (NEDA) is increasingly considered an important treatment goal, but it has never been tested for pediatric multiple sclerosis patients (ped-MS). We assessed 1-year NEDA and its subcomponents as well as MRI activity as early predictors of response to interferon- β therapy.

Methods: 72 ped-MS on interferon- β treatment were included. 1 year after treatment start, clinical and MRI assessments were performed. The longest clinical follow-up (11.33±6.29 years) was included for outcome variables. Multivariate regression models were used to identify predictors of treatment failure (defined as treatment switch for inefficacy) and EDSS worsening.

Results: No significant association was found between 1-year NEDA status or traditionally-defined MRI activity [new T2-hyperintense lesions or at least 1 gadolinium-enhancing (Gd)-lesion] and clinical outcomes. However, significant increase of treatment failure was associated with 2 or more relapses [hazard ratio (HR)=7.14, p=0.03] and more than 1 Gd-lesions (HR=3.18, p=0.05). According to these results, risk levels were grouped into 3 classes: group-1 (<2 relapses, no Gd-lesions), group-2 (either 2 or more relapses or 1 or more Gd-lesions), group-3 (2 or more relapses and 1 or more Gd-lesions). Group-2 patients had an intermediate risk of treatment failure (HR=2.93, p=0.002) and EDSS worsening (HR=2.85, p=0.002). Group-3 patients had highest risk of treatment failure (HR=7.89, p=0.002) and EDSS worsening (HR=8.26, p=0.001).

Conclusion: One-year NEDA and traditionally-defined MRI activity were not predictors of treatment failure in ped-MS. Clinical activity and ongoing MRI activity during the first year of interferon- β treatment indicated significant long-term risk of treatment failure and EDSS worsening.

Disclosure: Nothing to disclose

MS and related disorders 3

EPR1167

Body mass Index influence CD20 dynamics in MS patients treated with Ocrelizumab

A. Di Pietro, E. Signoriello, S. Casertano, F. Rossi, G. Abbadesa, G. Miele, M. Fratta, S. Bonavita, G. Lus University of Campania L. Vanvitelli, Naples, Italy

Background and aims: Kinetic of B-cells repopulation after depletion therapy with Ocrelizumab (OCR) shows great intra and inter-individual variance. Several evidence revealed a link between B-cell activity and adipose tissue. The aim of this study was to explore the influence of Body Mass Index (BMI) on kinetic of B-cell repopulation after treatment with OCR and on the treatment efficacy.

Methods: 108 MS patients were enrolled at the time of the 1st administration of OCR and followed-up prospectively. Clinical and instrumental activity and disability progression were analyzed to determine the treatment effectiveness. B-cell count was collected before the 1st dose administration and every 6 months. Based on B-cells count, patients were divided into 2 groups: with faster (FR) and e with slower repopulation rate (SR). The correlation between BMI, repopulation rate and treatment effectiveness was evaluated.

Results: After 1 year, reduction of annualized relapse rate and T1 gd-enhancing lesions were observed ($p < 0.001$) with higher percentage of NEDA (72%) and NEPAD (45.45%). Results disclosed that FR patients had higher BMI compared to patients with a lower BMI ($p < 0.001$). Contrariwise no correlation was disclosed between repopulation rate and treatment effectiveness.

Conclusion: Patients with higher BMI had faster repopulation rate; therefore further studies to verify the long-term efficacy of OCR in FR and SR in correlation to BMI and to evaluate the best administration schedule are sought after.

Disclosure: Nothing to disclose

EPR1168

Longitudinal study with optical coherence tomography (OCT) in treated patients with relapsing-remitting Multiple Sclerosis.

J. Díaz-Díaz¹, M.T. Merino Díez¹, L. Estefania Hidalgo¹, A. Valls Carbó¹, S. Noval Martín², M. Capote Díez², I. González-Suárez¹, I. Gómez Estévez¹, R. Sanchez Jean³, C. Oreja-Guevara¹

¹Neurology, Hospital Universitario Clínico San Carlos, Madrid, Spain, ²Ophthalmology, Hospital Universitario La Paz, Madrid, Spain, ³Ophthalmology, Hospital Universitario Clínico San Carlos, Madrid, Spain

Background and aims: Loss of retinal nerve fiber layer (RNFL) thickness in patients with Relapsing-remitting Multiple Sclerosis (RRMS) correlates with clinical and paraclinical parameters due to axonal and neuronal degeneration. We studied the treatment response in RRMS patients using OCT.

Methods: We retrospectively analyzed RNFL thickness by OCT at year 1 and 5 in patients treated or with fingolimod or dimethylfumarate (DMF). Demographic features, optic neuritis (ON) and annualize relapse rate (ARR) during treatment were also analyzed.

Results: We analyzed 24 patients with a mean age of onset of 31y (15-48y), 75% women and a medium follow-up of 10y from diagnosis. After 5 years, RNFL thickness was increased in 7 patients, 6 treated with Fingolimod with an increase of 5.4 μm and 1 patient with DMF with an increase of 0.5 μm . Also, 14 eyes improved in patients treated with Fingolimod vs 2 with DMF (table 1).

There were 19 patients without relapses during the 1st year, in these patients: RNFL increased in 5/9 Fingolimod vs 1/10 BG12. (table 2).

After 5 years of follow-up, 13 patients presented no relapses, in this group: RNFL increased in 4/7 patients treated with Fingolimod and 1/6 with DMF.

On other hand 75% of the patients with ≥ 1 relapse during the 5 years follow-up showed a RNFL decrease (table 3).

Table 1. RNFL results at year 0 and 5 of follow-up.

Thickness	Fingolimod	BG12	Total
	n ^o (median μm)	n ^o (median μm)	
Increase	14 (X: 5,0 \pm 3,7)	2 (1)	16
Decrease	7 (X: 5,5 \pm 4,7)	18 (X: 4,2 \pm 2,4)	25
Estable	3	4	7

Table 2. Fingolimod and BG12 RNFL in patients with ARR of 0 at year 1 and 5.

RNFL thickness	ARR 0 at year 1		ARR 0 at year 5	
	Fingolimod n=9 (median μm)	BG12 n=10 (median μm)	Fingolimod n=7 (median μm)	BG12 n=6 (median μm)
Increase	5 (X: 4,8 \pm 3,1)	1 (X: 0,5)	4 (X: 5,8 \pm 2,6)	1 (X: 0,5)
Decrease	4 (X: 2,6 \pm 1,9)	9 (X: 3,3 \pm 1,5)	3 (X: 2,0 \pm 1,8)	5 (X: 3,2 \pm 1,7)

Table 3. RNFL in patient with relapse at first years and during 5 years of follow-up

RNFL thickness	ARR ≥ 1 at year 1		ARR ≥ 1 over 5 years	
	Fingolimod n=3 (median μm)	BG12 n=1 (median μm)	Fingolimod n=5 (median μm)	BG12 n=6 (median μm)
Increase	1 (X: 8,5)	0	2 (X: 4,8)	0
Decrease	2 (X: 3)	1 (X: 7,0)	3 (X: 3,5)	5 (X: 4,2)
Estable	0	0	0	1

Conclusion: After 5 years of follow-up 50% of patients treated with fingolimod increase RNFL vs 10% of BG12. Most of patients with relapses over 5 years have a decrease of RNFL. OCT could be used as a response biomarker.

Disclosure: Nothing to disclose

EPR1169

Neuromyelitis optica spectrum disorders associated with aquaporin-4 antibodies and MOG antibodies: a nationwide Portuguese registry

M.E.A.M. Dos Santos¹, J. Guimaraes², A. Martins Silva¹, I. Correia³, J. Ferreira⁴, A.S. Correia⁵, S. Figueiroa⁶, F. Sousa⁷, M. Sequeira⁸, F.M.F. Palavra⁹, A. Andre¹⁰, M. Arenga¹¹, I. Mendes¹², I. Brás Marques¹³, S. Perdigo¹⁴, H. Felgueiras¹⁵, L.D.A.M.M. Isidoro¹⁶, R. Guerreiro¹⁷, H. Nzwalo¹⁰, M. Santos¹⁸, A. Palos¹⁹, Â. Timóteo²⁰, A. Morganho²¹, C. Carmona²², I. Alves²³, F. Correia²⁴, C. Barroso²⁵, P. Carneiro²⁶, M.I. Leite²⁷, M.J. Sá²

¹Neurology, Centro Hospitalar Universitário do Porto – Hospital de Santo António (CHUP-HSA), Porto, Portugal,

²Neurology, Centro Hospitalar de São João, Porto,

Portugal, ³Neurology, Centro Hospitalar e Universitário de Coimbra, Coimbra, Portugal, ⁴Neurology, Centro Hospitalar de Lisboa Norte – Hospital de Santa Maria, Lisbon,

Portugal, ⁵Hospital Egas Moniz - CHLO, Lisbon, Portugal,

⁶Child Neurology Department, Centro Hospitalar do Porto,

Porto, Portugal, ⁷BRAGA, Portugal, ⁸Lisbon, Portugal,

⁹Coimbra, Portugal, ¹⁰Faro, Portugal, ¹¹Neurology

Department, Centro Hospitalar Cova da Beira – Hospital da Covilhã, Covilha, Portugal, ¹²Almada, Portugal,

¹³Neurology, Hospital da Luz, Lisbon, Portugal, ¹⁴Viana

Castelo, Portugal, ¹⁵Neurology, Centro Hospitalar Vila Nova de Gaia/Espinho, Vila Nova de Gaia, Portugal, ¹⁶Viseu,

Portugal, ¹⁷Neurology, Centro Hospitalar de Setúbal,

Setúbal, Portugal, ¹⁸Amadora, Portugal, ¹⁹Neurology,

Hospital Distrital de Santarém, Santarém, Portugal,

²⁰Neurology, Hospital Beatriz Ângelo, Loures, Portugal,

²¹Neurology Department, Hospital Nelio Mendonça,

Funchal, Portugal, ²²Neurology, Hospital de Cascais,

Cascais, Portugal, ²³Neurology, Centro Hospitalar Tâmega e Sousa, Penafiel, Portugal, ²⁴Matosinhos, Portugal,

²⁵Hospital Vila Franca de Xira, Vila Franca Xira, Portugal,

²⁶Laboratory of Immunology, Centro Hospitalar do Porto,

Porto, Portugal, ²⁷Nuffield Department of Clinical

Neurosciences, John Radcliffe Hospital, University of Oxford, Oxford, United Kingdom

Introduction: Neuromyelitis optica spectrum disorders (NMOSD) are rare and heterogeneous immune-mediated CNS conditions. Accurate diagnosis is fundamental once early treatment has impact on prognosis and quality of life. Their epidemiological, clinical and laboratory characteristics in the Portuguese population were unknown.

Objective: To identify the Portuguese patients with seropositive NMOSD and study their epidemiological-

demographic and clinical-serological characteristics.

Methods: National study. 24 adult centres and 3 neuropediatric units included all NMOSD patients that met the Wingerchuk 2015 criteria.

Results: We identified 145 seropositive NMOSD. 77 AQP4-Ab and 68 MOG-Ab positive. Portuguese population in 2018 was 10.276.617. We established prevalence for seropositive NMOSD of 1.41/100.000 (0.75/100.000 for AQP4-Ab; 0.66/100.000 for MOG-Ab). In 2018 there were 24 new seropositive NMOSD cases (9AQP4-Ab and 15MOG-Ab). Estimated incidence was 0.23/100.000 (0.09/100.000 for AQP4-Ab and 0.15/100.000 for MOG-Ab). Females predominated in AQP4-Ab compared to MOG-Ab subgroups (F:M ratio of 8.6:1 vs 1.6:1). Onset-age was higher in AQP4-Ab than MOG-Ab patients (40.7yo vs 34.8yo). Non-Caucasians predominated in the AQP4-Ab subgroup (10.4% vs 2.9%). Other autoimmune diseases were more frequent in AQP4-Ab than in MOG-Ab disease (23.4% vs 4.4%). Myelitis was the most frequently reported presenting syndrome (42.9%) in AQP4-Ab and optic neuritis in MOG-Ab (42.6%).

Conclusion: Discussion: Epidemiological, demographic and clinical characteristics of NMOSD in Portugal are similar to other published series, including European, which confirms the quality of the clinical and laboratory diagnosis of NMOSD throughout the country.

Disclosure: This project received a grant from Roche.

EPR1170

Assessing the contribution of genetic factors on brain MRI lesion load and volumetric measures in multiple sclerosis patients.

F. Esposito¹, M.A. Rocca², S. Santoro³, E. De Meo², L. Ferre¹, F. Martinelli Boneschi⁴, F. Clarelli³, M. Filippi²

¹Department of Neurology and Laboratory of Human Genetics of Neurological Disorders, Institute of Experimental Neurology, San Raffaele Scientific Institute, Milan, Italy, ²Department of Neurology and Neuroimaging Research Unit, Institute of Experimental Neurology, Division of Neuroscience, San Raffaele Scientific Institute, Milan, Italy, ³Laboratory of Human Genetics of Neurological Disorders, Institute of Experimental Neurology, San Raffaele Scientific Institute, Milan, Italy, ⁴Neurology Unit, Cà Granda Ospedale Maggiore Policlinico and Department of Biomedical Sciences for Health, University of Milan, Milan, Italy

Background and aims: Genetic determinants of heterogeneous disease expression are partially investigated in multiple sclerosis (MS). We aimed at identifying genetic factors influencing quantitative neuroimaging outcomes in two cohorts of Relapsing Remitting (RRMS) and Progressive (PMS) subjects.

Methods: 214 RRMS and 99 PMS patients underwent a brain MRI using a 3T scanner. 9 MRI metrics were obtained, spanning from conventional T1/T2 lesion to cortical lesion load and deep grey-matter volume measurements. A knowledge-driven candidate pathway strategy was adopted; brain cell-specific sets of enriched expressed genes were also tested. A self-contained gene set analysis was carried out, using Adaptive Rank Truncated Product method and adjusting for relevant confounders, followed by single SNP regression analysis.

Results: We tested seventeen KEGG pathways, 42 GO terms and 5 cell-specific enriched gene sets, encompassing ~189k SNPs. Gene set analysis revealed a differential pattern of association between the 2 disease subtypes, with processes related to Iron and Leukocyte Migration associated in PMS ($p < 0.01$), whereas inflammatory-related themes like Adaptive Immune Response and T-cell Differentiation appeared to be implicated in RRMS ($p < 0.01$). As of SNPs, we found evidence of association between white matter volume and rs740948 mapping to SEMA3A gene ($\beta = 2.2 \times 10^4$, $p = 5.5 \times 10^{-6}$) in RRMS, while rs7104613 mapping to SPON1 gene revealed to be significantly associated to reduced deep grey matter and thalamus volumes ($\beta = -731.9$, $p = 3.2 \times 10^{-7}$) in the PMS.

Conclusion: These data suggest a different pattern of association between neuroimaging metrics and functional processes across the two disease courses. A replication step in larger cohorts is warranted to validate these preliminary findings.

Disclosure: Nothing to disclose

EPR1171

Clinical outcomes of lymphoablative autologous hematopoietic stem cell transplantation (AHSCT) in multiple sclerosis (MS) patients

D. Fedorenko¹, I. Nikolaev², D. Kanshina²

¹Department of Hematology and chemotherapy with bone marrow and hematopoietic stem cell transplantation unit, Federal state budgetary institution "National Medical and Surgical Center named after N.I. Pirogov" of the Ministry of Healthcare of the Russian Federation, Moscow, Russian Federation, ²Neurology Department for patients with cerebral circulation disorders, Federal state budgetary institution "National Medical and Surgical Center named after N.I. Pirogov" of the Ministry of Healthcare of the Russian Federation, Moscow, Russian Federation

Background and aims: We aimed to study if the reduced intensity regimen based on BEAM is safe and effective in MS patients.

Methods: A total of 135 patients were enrolled in the study: mean age – 34 (range-17-54) y.o; male/female – 53/82; mean EDSS-3.5 (range-1,5-8,5). Relapsing-remitting MS (RRMS) – 60 patients, 75 patients – progressive MS. Reduced-intensity BEAM-like conditioning was used (BCNU 300mg/m², etoposide 100mg/m², Ara-C 100mg/m² and melphalan 100mg/m²). Median follow-up was 24 months. Efficacy was evaluated based on EDSS and MRI changes.

Results: No transplant related deaths were observed. The mobilization and transplantation procedures were well tolerated. Estimated event-free survival at median follow-up of 48.9 months was 80%: 83.3% for relapsing-remitting MS versus 75.5% for progressive MS. EDSS scores improved significantly from a pretransplant median of 3.5 to 2.0 at 18 months after AHSCT; positive EDSS changes preserved at 36 months follow-up. Results of MRI scans at long-term follow-up were available in 55 patients. 15 patients (27%) had active lesions at baseline and all turned to inactive status except one case. Of the 40 patients without active lesions pre-transplant 39 remained inactive, whereas 1 patient showed disease activity at 6 months posttransplant. At long-term follow-up no active, new or enlarging lesions were registered in patients without disease progression/relapse. In total, no negative changes on MRI scans were registered in 93% patients.

Conclusion: The results of study support the feasibility of reduced-intensity condition regimen based on BEAM. AHSCT with reduced-intensity condition regimen may be beneficial for patients with various types of MS.

Disclosure: Nothing to disclose

EPR1172

Assessment of clinical, genetic and immune repertoire data to predict disease activity and progression in relapsing-remitting Multiple Sclerosis patients

L. Ferrè¹, S. Santoro², M. Tosi², E. Mascia², M. Sorosina², F. Clarelli², L. Moiola³, V. Martinelli³, G. Comi⁴, M. Filippi³, F. Esposito⁵

¹Department of Neurology, Laboratory of Human Genetics of Neurological Disorders, Vita-Salute San Raffaele University and San Raffaele Hospital, INSPE, Milan, Italy, ²Laboratory of Human Genetics of Neurological Disorders, San Raffaele Hospital and INSPE, Milan, Italy, ³Department of Neurology, San Raffaele Hospital and INSPE, Milan, Italy, ⁴Vita-Salute San Raffaele University, Milan, Italy, ⁵Department of Neurology, Laboratory of Human Genetics of Neurological Disorders, San Raffaele Hospital and INSPE, Milan, Italy

Background and aims: Multiple Sclerosis (MS) has a highly heterogeneous clinical course and, given the broad spectrum of approved therapies, there is a strong need to identify parameters that can guide treatment choice. The present study investigates clinical, genetic and immunological parameters associated with MS severity.

Methods: An “Extended” cohort of ~1,000 patients that started a 1st-line drug, with available clinical and genetic data, and a “Core” dataset of ~200 patients with genetic and immune repertoire information obtained before 1st-line treatment were enrolled. The following outcomes were considered at the 4-year follow-up: NEDA-3 criterion, time to first relapse (TFR), EDSS and MS Severity Score (MSSS). A regression analysis was performed on both cohorts and results were meta-analyzed.

Results: A younger age at onset (AAO) and a shorter disease duration strongly correlate with higher inflammatory activity; a higher baseline EDSS and AAO are the best prognostic markers of disability increase. The genetic study identified some interesting signals with suggestive association: rs6925307 was associated with NEDA (OR 0.55, p:1.53e-06) and has an eQTL effect on CLVS2 gene, required for normal morphology of endosomes and lysosomes in neurons. Rs9264731, an intronic variant in the HLA-C gene, was associated with TFR (HR 1.49, p:4.11e-06). T-cell receptor (TCR) sequencing is ongoing and immune repertoire data are already available for 61 patients with >4.000.000 clonotypes identified.

Conclusion: We confirmed the association of clinical parameters with disease severity and we identified some interesting genetic markers whose association need to be replicated. TCR data are being generated and will be integrated in a predictive model of disease activity.

Disclosure: This study was funded by the Italian Ministry of Health, project code: GR-2016-02363997

EPR1173

Depression and Anxiety in Multiple Sclerosis Patients: the role of genetic variability of Interleukin 1-beta

A. Ferreira¹, B. Leal¹, I. Ferreira², S. Brás¹, I. Moreira³, A. Bettencourt¹, R. Samoes², D. Lopes², D. Boleixa², A.P. Sousa², E. Santos⁴, B. Silva⁵, P. Pinho Costa⁶, S. Cavaco⁷, A. Martins Da Silva⁸

¹Unit for Multidisciplinary Research in Biomedicine (UMIB), Abel Salazar Institute of Biomedical Sciences, University of Porto – ICBAS/UP, Porto, Portugal, ²Centro Hospitalar e Universitário do Porto - Hospital de Santo António, Porto, Portugal, ³Neuropsychology, Centro Hospitalar do Porto - Hospital de Santo António, Porto, Portugal, ⁴Neurology, Centro Hospitalar do Porto - Hospital Santo António, Porto, Portugal, ⁵UMIB, Instituto de Ciências Biomédicas Abell Salazar (ICBAS-UP), Porto, Portugal, ⁶Instituto nacional de saúde Dr. Ricardo Jorge, Porto, Portugal, ⁷Neuropsychology Unit, Centro Hospitalar do Porto - Hospital de Santo António, Porto, Portugal, ⁸Centro Hospitalar do Porto, Porto, Portugal

Background and aims: Mood disorders, as depression and anxiety, are frequent in Multiple Sclerosis (MS) patients. High pro-inflammatory cytokine levels (e.g. IL-1beta) have been reported in depressed individuals. The aim of this study was to investigate whether rs16944 (-511C>T) polymorphism, a modulator of IL-1beta expression, contributes to depression and anxiety susceptibility in MS patients.

Methods: Hospital Anxiety and Depression Scale (HADS) was initially (T1) applied to 393 MS patients (63.6% female, 39±11 years of age, 10±8 disease duration, EDSS 2.9±2.2; 318 relapsing-remitting, 38 2ndary progressive, and 37 primary progressive). HADS cut-off scores for depression and anxiety were respectively ≥8 and ≥11. The HADS was applied four years later (T2) to 176 MS patients. The rs16944 polymorphism was genotyped by allelic-specific Taqman probes.

Results: Depression was identified in 29.5% of patients at T1 and 34.7% at T2, whereas anxiety was found in 27% at T1 and 16.5% at T2. Persistent depression and anxiety (T1 and T2) were observed in 19.9% and 11.9% of MS patients, respectively. MS patients who were carriers of rs16944C allele exhibited lower predisposition to depression and anxiety at T1 and at T2 (pD1=0.001 and pA1=0.005; pD2<0.001 and pA2=0.027). This association was also observed with persistent psychopathological indices, even when taking into account clinical and demographical characteristics (pD=0.001 and pA=0.019).

Conclusion: The study results support the protective role of rs16944C allele in depression and anxiety in MS patients and reinforce the role of inflammation in the development of psychopathology.

Disclosure: Nothing to disclose

EPR1174

Baseline characteristics of multiple sclerosis patients enrolled in NOVA, a multicentre, randomised trial to assess the efficacy of natalizumab every-6-weeks dosing

J. Foley¹, G. Defer², L. Zhovtis Ryerson³, J.A. Cohen⁴, D.L. Arnold⁵, H. Butzkueven⁶, G. Cutter⁷, G. Giovannoni⁸, J. Killestein⁹, H. Wiendl¹⁰, Z. Ren¹¹, P.-R. Ho¹¹, P. Wolstencroft¹¹, S. Xiao¹¹, N. Campbell¹¹

¹Rocky Mountain MS Clinic, Salt Lake City, USA,

²Department of Neurology, Centre Hospitalier Universitaire de Caen, Caen, France, ³Department of Neurology, NYU Langone Health, New York University, New York, USA,

⁴Cleveland Clinic, Cleveland, USA, ⁵Montreal Neurological Institute and Hospital, McGill University, Montreal, Canada,

⁶Melbourne, Australia, ⁷University of Alabama School of Public Health, Birmingham, USA, ⁸Blizard Institute, Barts and The London School of Medicine and Dentistry, Queen Mary University of London, London, United Kingdom,

⁹Department of Neurology, MS Center Amsterdam, VU University Medical Center, Amsterdam, Netherlands,

¹⁰Department of Neurology, University of Münster, Münster, Germany, ¹¹Biogen, Cambridge, USA

Background and aims: Natalizumab is associated with increased progressive multifocal leukoencephalopathy (PML) risk. Extended interval dosing (EID) is associated with significantly lower PML risk in anti-JC virus (JCV) antibody-positive patients, but the efficacy of EID has not been established in a randomised, controlled trial. NOVA is the 1st prospective, interventional, controlled, randomised study to assess efficacy of natalizumab every-6-weeks (Q6W) dosing compared with every-4-weeks (Q4W) dosing (ClinicalTrials.gov NCT03689972). The primary study endpoint is the number of new/newly enlarging T2 lesions at 72 weeks. Key 2ndary endpoints include number of new gadolinium-enhancing lesions, time to 1st relapse, annualized relapse rate, and adverse events.

Methods: Relapsing-remitting MS patients stable on natalizumab 300mg Q4W dosing for ≥ 1 year were randomised 1:1 to remain on Q4W or switch to Q6W dosing. Baseline characteristics were assessed using summary statistics.

Results: As of November 2019, NOVA was fully enrolled; 487 patients were randomised (244 Q6W, 243 Q4W). Treatment groups were well-balanced with respect to key demographic and disease characteristics, including age, weight, time since MS diagnosis, number of relapses in the year before natalizumab initiation, and duration of natalizumab exposure (Table). The majority of patients were anti-JCV antibody-negative at the start of the study (Q6W=78.3%; Q4W=80.7%); median anti-JCV antibody index values were identical for the 2 treatment groups (Table).

Category	Q6W (n=244)	Q4W (n=243)	Overall (N=487)
Age, years			
n	244	242	486
Mean (SD)	41.1 (9.7)	40.3 (10.0)	40.7 (9.8)
Female, n (%)	172 (70.5)	176 (72.4)	348 (71.5)
Weight, kg			
n	243	242	485
Mean (SD)	79.8 (19.6)	78.4 (20.2)	79.1 (19.9)
Natalizumab exposure, years			
n	239	236	475
Mean (SD)	4.7 (3.0)	4.7 (2.8)	4.7 (2.9)
EDSS score			
n	239	240	479
Mean (SD)	2.35 (1.30)	2.31 (1.31)	2.33 (1.30)
Time since MS diagnosis, years			
n	237	231	468
Mean (SD)	9.5 (6.2)	9.2 (6.1)	9.3 (6.1)
Relapses in year prior to natalizumab initiation			
n	233	227	460
Mean (SD)	1.1 (1.1)	1.0 (0.9)	1.0 (1.0)
Anti-JCV serostatus			
Anti-JCV antibody-negative, n/N (%)	191/242 (78.9)	196/242 (81.0)	387/484 (80.0)
Anti-JCV antibody-positive, n/N (%)	51/242 (21.1)	46/242 (19.0)	97/484 (20.0)
JCV index			
n	239	237	476
Median (Q1, Q3)	0.15 (0.11, 0.27)	0.15 (0.11, 0.22)	0.15 (0.11, 0.25)

Table. Baseline characteristics of RRMS patients enrolled in NOVA. EDSS=Expanded Disability Status Scale; Q1, Q3=quartile 1, quartile 3; RRMS=relapsing-remitting MS; SD=standard deviation.

Conclusion: Baseline characteristics of Q6W and Q4W NOVA patients were well-matched. Efficacy results from NOVA (expected June 2021), combined with the prior TOUCH database PML risk assessment, will help define the benefit/risk profile of natalizumab Q6W.

Disclosure: This study is supported by Biogen. Detailed disclosures of each author will be included in the e-poster/oral presentation.

EPR1175

Reversibility of Clinical Abnormalities Associated with Ponesimod: Results from Randomised Phase II Core and Extension Studies in Relapsing Remitting Multiple Sclerosis

M.S. Freedman¹, C. Pozzilli², E.K. Havrdova³, P.K. Coyle⁴, A. Lemle⁵, M. Burcklen⁵, A. Larbalestier⁵, B. Hennessy⁵, T. Scherz⁵, A. Vaclavkova⁵, T. Olsson⁶
¹The University of Ottawa and the Ottawa Hospital Research Institute, Ottawa, ON, Canada, ²Faculty of Medicine, Sapienza University of Rome, Rome, Italy, ³Department of Neurology and Center for Clinical Neuroscience, First Medical Faculty, Charles University, Prague, Czech Republic, ⁴Stony Brook University Medical Center, Stony Brook, New York, USA, ⁵Actelion Pharmaceuticals Ltd, Part of Janssen Pharmaceutical Companies, Allschwil, Switzerland, ⁶Karolinska Institutet; Stockholm, Sweden

Background and aims: Ponesimod, an orally active, selective sphingosine 1-phosphate receptor-1 (S1P1) modulator, showed benefits in clinical and MRI outcomes in patients with relapsing-remitting multiple sclerosis (RRMS) in a double-blind, placebo-controlled, phase-2b Study. Patients could then roll-over into an ongoing Extension Study.

Objective: Characterise reversibility of ponesimod-mediated changes in lymphocyte count, pulmonary function, and blood pressure (BP).

Methods: 435 patients with RRMS received ≥ 1 dose of ponesimod (10/20/40mg/day) during Core and/or the Extension Study. The 40mg and 10mg doses were subsequently discontinued during Treatment Period-1 (TP1) and TP2 of Extension Study. All patients received 10mg or 20mg during TP2, followed by open-label 20mg in TP3. Changes from baseline in lymphocyte count, pulmonary function tests (PFT; FEV1 and FVC), systolic and diastolic BP (SBP and DBP) were assessed 7-, 30- and 90-days after discontinuation of ponesimod.

Results: Treatment was ongoing in 214 patients as of 31-March-2019; results cover patients who prematurely discontinued from ponesimod at any time during the studies. With 20mg treatment at last-on-treatment visit, mean baseline lymphocyte count was reduced by 61.7% and returned to near-baseline at follow-up Days 7 (-17%) and 30 (-7.9%); with no evidence of rebound (Table_1). For all groups, mean changes from baseline in SBP/DBP observed after stopping ponesimod treatment returned to near-baseline values by follow-up Days 7 and 30. Similarly, mean FVC/FEV1 declined on treatment, partially recovered at follow-up Day-7 and remained stable at Day-30 (Table_2).

Table 1: Change from baseline in lymphocyte count, systolic and diastolic blood pressure over time

Mean (SD) change from baseline	Ponesimod		
	10 mg (n=42)	20 mg (n=54)	40 mg (n=66)
Lymphocyte count, % change			
Last on-treatment Visit	-51.3 (16.50)	-61.7 (19.20)	-65.6 (16.70)
Follow-up Day 7	-6.5 (35.71)	-17.7 (29.01)	-19.0 (30.24)
Follow-up Day 30	0.7 (31.05)	-7.9 (27.66)	-8.9 (32.60)
Follow-up Day 90	20.2 (67.34)	-12.1 (21.79)	-14.7 (23.97)
Last follow-up	5.4 (44.89)	-5.6 (27.14)	-6.1 (30.34)
	n=44	n=53	n=65
Systolic Blood Pressure (absolute change, mmHg)			
Last on-treatment Visit	2.5 (15.9)	4.1 (13.9)	5.3 (13.0)
Follow-up Day 7	2.3 (12.4)	3.7 (15.4)	5.6 (11.8)
Follow-up Day 30	-0.4 (10.5)	0.4 (13.1)	3.2 (11.5)
Follow-up Day 90	3.1 (11.3)	-2.4 (17.2)	2.1 (12.5)
Last follow-up	0.8 (10.5)	0.1 (14.6)	3.5 (11.6)
Diastolic Blood Pressure (absolute change, mmHg)			
Last on-treatment Visit	-0.5 (12.9)	1.7 (8.8)	1.7 (11.8)
Follow-up Day 7	2.4 (11.7)	1.5 (10.2)	0.5 (8.5)
Follow-up Day 30	0.1 (10.1)	0.8 (11.1)	0.0 (9.7)
Follow-up Day 90	1.7 (11.4)	-0.0 (8.8)	-1.6 (9.9)
Last follow-up	-0.1 (10.2)	0.5 (10.2)	-1.1 (10.3)

Data presented here are from subset of patients who prematurely discontinued from ponesimod treatment at any time during the Core or Extension study

Table 2. Change from baseline in pulmonary function test parameters over time

Mean (SD) change from baseline	Ponesimod		
	10 mg (n=43)	20 mg (n=52)	40 mg (n=65)
Forced Expiratory Volume in 1 Second (FEV₁) (% change)			
Last on-treatment Visit	-8.1 (8.77)	-8.8 (12.94)	-13.7 (11.03)
Follow-up Day 7	-4.7 (11.25)	-6.0 (13.63)	-6.7 (8.61)
Follow-up Day 30	-4.3 (8.95)	-5.5 (10.84)	-4.5 (8.66)
Follow-up Day 90	-6.8 (11.33)	-6.0 (10.65)	-7.5 (7.35)
Last follow-up	-3.8 (9.81)	-5.6 (10.56)	-4.9 (8.95)
Forced Vital Capacity (FVC) (% change)			
Last on-treatment Visit	-1.7 (12.33)	-2.3 (11.99)	-6.9 (8.63)
Follow-up Day 7	0.4 (12.82)	-1.1 (11.49)	-4.5 (10.28)
Follow-up Day 30	0.4 (12.57)	-1.3 (12.13)	-1.1 (14.68)
Follow-up Day 90	0.9 (17.52)	-1.4 (13.01)	-4.5 (9.88)
Last follow-up	0.8 (11.62)	-1.1 (11.16)	-1.8 (14.24)

Data presented here are from subset of patients who prematurely discontinued from ponesimod treatment at any time during the Core or Extension study

Conclusion: Changes observed in lymphocytes and BP during ponesimod treatment were rapidly reversible following treatment discontinuation, with partial recovery in PFT.

Disclosure: Funding was provided by Janssen Research & Development, LLC, and the study was supported by Actelion Pharmaceuticals, Part of Janssen Pharmaceutical Companies, Allschwil, Switzerland.

EPR1176

Neurofilament light chain level in paired CSF and serum samples of patients with multiple sclerosis: a prospective study

M. Zanoni¹, M. Bongianni², S. Mariotto², R. Orlandi², M. Calabrese², F. Gobbin², A. Gajofatto²

¹Verona, Italy, ²Department of Neurosciences, Biomedicine and Movement Sciences, University of Verona, Verona, Italy

Background and aims: To assess whether neurofilament light chain (NFL) level in CSF and serum of multiple sclerosis (MS) patients could represent a clinically feasible biomarker of disease activity and progression.

Methods: Between 2014 and 2017, we consecutively recruited patients with clinically/radiologically isolated syndromes (CIS/RIS) or MS according to 2010 McDonald criteria, and availability of paired CSF/serum samples stored at -80°C at Verona University Hospital. NFL concentration was assessed in CSF by ELISA (UmanDiagnostics) and in serum by Single Molecular Array (Simoa®, Quanterix). Possible associations of NFL levels with clinical and MRI measures of interest were analyzed, including relapses, disability worsening, and MRI measures (i.e. enhancing lesions, T2-lesion volume, cortical lesions, and brain volume).

Results: We enrolled 90 patients (55 females) with mean age at sampling 37±12 years. 75 patients had a relapsing form of disease, 14 progressive, and 1 RIS. Median follow-up duration was 32 months (0-133). CSF and serum NFL were correlated ($r=0.752$, $p<0.001$). We observed a correlation between serum NFL and EDSS score at sample collection ($r=0.22$, $p=0.045$). In addition, both CSF and serum NFL were higher in patients with enhancing lesions on brain MRI. There was a modest albeit highly significant correlation of both CSF and serum NFL with T2-lesion volume on brain MRI. We did not observe a fully significant association of NFL with both relapse occurrence and disability progression after sampling.

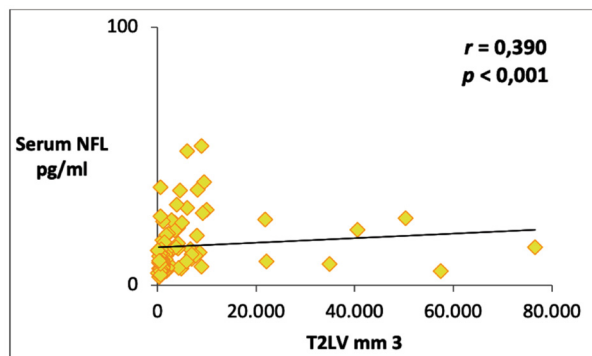

correlation between serum NFL and T2 lesion volume on brain MRI

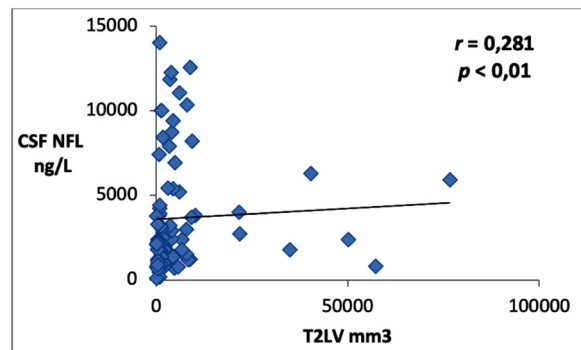

correlation between CSF NFL and T2 lesion volume on brain MRI

Conclusion: NFL concentration mainly reflect acute disease activity in MS. Clinical implementation as predictive biomarker at the individual patient level requires additional evidence.

Disclosure: This work was supported by research grants of Merck and Cariverona Foundation

EPR1177

Cognitive change in people with multiple sclerosis – 5 year follow-up of the original Irish BICAMS validation cohort.

M. Gaughan¹, R. Monaghan², K. O'connell³, F. O'keeffe², C. McGuigan²

¹Dublin, Ireland, ²St. Vincent's University Hospital, Dublin, Ireland, ³Department of Neurology, St Vincent's University Hospital, Dublin, Ireland

Background and aims: Cognitive impairment affects 20-40% of people with recently diagnosed multiple sclerosis and greater than 50% of people with progressive MS. Cognitive impairment predicts future vocational status, income, adherence to treatment and behaviour. Limited data exists on evolution of cognition over time.

Methods: 67 pwMS who were part of the original BICAMS validation cohort in 2014 were invited for 5-year follow up assessment. Single Digit Modality Test (SDMT), California Verbal Learning Test (CVLT-2) and Brief Visual MTR (BVMTR) as well as comprehensive assessments of mood, fatigue and quality of life were performed. BVMTR (2014) was re-scored to ensure inter-rater reliability.

Results: 50 pwMS returned for follow up assessment. 33% of this cohort had cognitive impairment on at least one domain of BICAMS at baseline. The mean age at follow up was 49 years (SD12). There was no difference in SDMT at five years ($p=0.95$). There was a significant improvement in BVMTR ($p=0.002$) and CVLT ($p=0.002$) over 5 years. Anxiety scores were stable over time, but there was a significant improvement in depression scores ($p=0.0001$). There was no correlation between anxiety, depression or fatigue and cognitive measures. There was however a strong correlation between depression and fatigue scores ($r=.71$, $p<0.001$).

Conclusion: There is a trend towards cognitive stability over 5 years in a cohort of pwMS. Practice effects are unlikely to impact the results given the long interval between testing. Treatment with DMTs may have had an impact on preservation of cognition. Predictors of cognitive stability remain elusive.

Disclosure: This research is supported by Newman fellowship, University College Dublin.

Muscle and neuromuscular junction disease 1

EPR1178

The neglected IgG1-3 antibodies in MuSK myasthenia gravis: novel evidence for their pathogenicity

M. Cao¹, J. Cossins¹, W. Liu¹, S. Maxwell¹, R. Webster¹, D. Beeson², A. Vincent³

¹Nuffield Department of Clinical Neurosciences, University of Oxford, Oxford, United Kingdom, ²Neurosciences Group, Nuffield Department of Clinical Neurosciences, Weatherall Institute of Molecular Medicine, University of Oxford, Oxford, United Kingdom, ³Oxford, United Kingdom

Background and aims: Muscle Specific Kinase (MuSK)-myasthenia gravis (MG) is an autoimmune disease that impairs neuromuscular transmission leading to generalised muscle weakness. Under physiological conditions, MuSK is activated by agrin and initiates a phosphorylation cascade leading to the clustering of acetylcholine receptors (AChRs) at the neuromuscular junction. In MuSK-MG, MuSK autoantibodies - mainly monovalent IgG4 - inhibit MuSK phosphorylation and disperse AChR clusters. Divalent MuSK-IgG1-3s co-exist at lower levels and also inhibit agrin-induced AChR clustering in vitro. However, the mechanism of action of divalent IgG1-3 MuSK antibodies are unknown.

Methods: C2C12 myotubes were incubated with IgG1-3 or IgG4 antibodies purified from MuSK-MG patients. Phosphorylation and expression of MuSK, DOK7, and the β subunit of AChR were measured by western blotting. AChR clusters were labelled with α -bungatatorxin-594 and counted.

Results: After 45 min incubation, IgG1-3 increased MuSK and DOK7 phosphorylation compared with inhibition of phosphorylation by IgG4. After overnight exposure, IgG1-3 increased AChR microclusters (<3 μ m) but failed to induce fully-mature clusters (>3 μ m). Incubations for 1, 2, 4 and 8 hours showed that IgG1-3 and agrin increased MuSK, DOK7 and β AChR phosphorylation with a similar time-course but, whereas agrin progressively increased AChR cluster numbers, IgG1-3 did not.

Conclusion: MuSK-IgG1-3 antibodies are pathogenic but act through different mechanisms to MuSK-IgG4 antibodies. They stimulate MuSK-DOK7 phosphorylation cascade but fail to induce fully-formed AChR clusters. These effects are likely due the result of divalent binding to MuSK compared with binding of monovalent IgG4. The possible down-stream mechanisms are being explored further and will be discussed.

Disclosure: Nothing to disclose

EPR1179

Efficacy and safety of Rituximab in myasthenia gravis: a multicentric real life study

A. Dos Santos¹, J.B. Noury², A. Nadaj Pakleza³, J. Cassereau⁴, C. Baron⁵, L. Michel⁶, S. Wiertelowski¹, A. Magot⁷

¹Service de Neurologie, CHU de Nantes, NANTES, France, ²Service des Explorations fonctionnelles de Neurologie, CHU de Brest, Brest, France, ³Service des Explorations fonctionnelles de Neurologie, CHU de Strasbourg, Strasbourg, France, ⁴Service des Explorations fonctionnelles de Neurologie, CHU d'Angers, ANGERS, France, ⁵Service des Explorations fonctionnelles de Neurologie, CHU de Poitiers, Poitiers, France, ⁶Service de Neurologie, CHU de Rennes, Rennes, France, ⁷Neuromuscular Reference Center, CHU Nantes, Nantes, France

Background and aims: 15% of patients suffering of myasthenia gravis (MG) are refractory and needed a 2nd line immunosuppressive treatment; some case reports and studies show the probable benefit of Rituximab in these cases. Our objective was to demonstrate the efficacy and safety of Rituximab in refractory and steroid-dependent MG.

Methods: In this French retrospective and multicentric study, inclusions criteria were age >18 years old, MG with Acetylcholine receptor (AChR) antibodies, Musk antibodies positive or significative decrement on electromyogram), MG Foundation America (MGFA) score >II, refractory or steroid-dependent MG, treatment by Rituximab.

The protocol of infusion was determined by the neurologist. Efficacy was evaluated by MGFA Post interventional (PIS) score at 6 months, the Garches' score and decrease of steroids under 10mg at 6 months. Adverse events were collected.

Results: 27 patients are included in 6 French departments of Neurology: 19 AChR MG, 4 Musk MG and 2 seronegative MG. 81.4% of patients had a MGFA PIS improved or better after 6 months of treatment (p<0.0001). The mean Garches' score increased from 65.29 to 84.23 at 6 months (p<0.0001). The decrease of steroids (<10mg), was effective in 66.6% of treated patients at 6 months. 40% of patients presented adverse events: 18% infections, 7% infusion reaction, 3.7% bradycardia, 7% cytopenia.

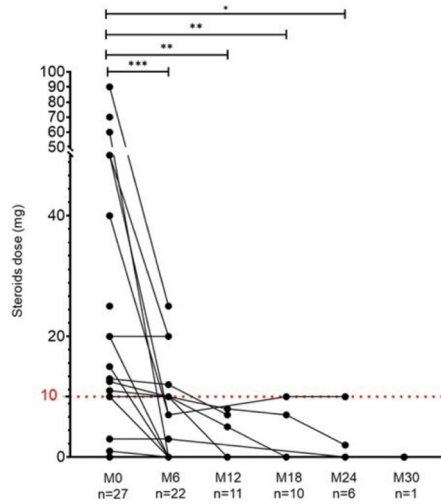

Figure 2: Dose of steroids at each cure of Rituximab. Dose of steroid by patients at cure of RITUXIMAB, M: Month, mg: milligrams Test de Wilcoxon; ***:p<0,001 **:p<0,01, *:p<0,05

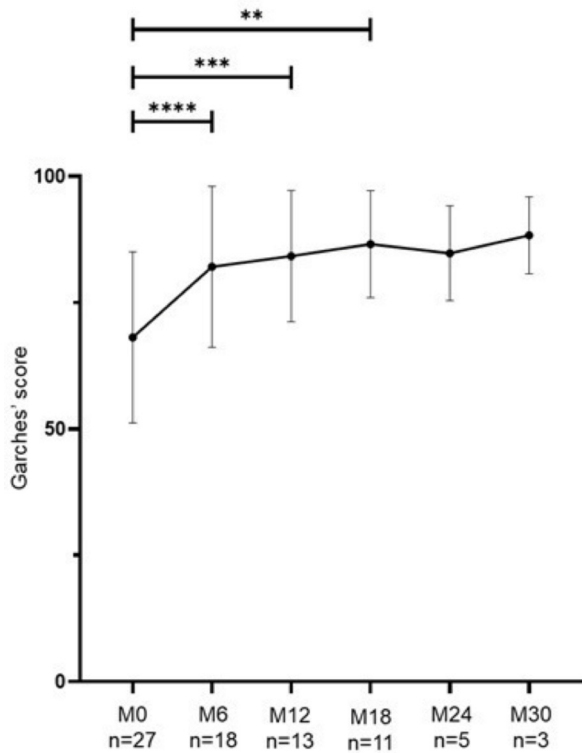

Figure 1: Garches' Score at each infusion of Rituximab. Mean± Standard deviation, M: months, n: number of patients at each infusion of Rituximab, mg: milligrams Wilcoxon test; ****: p<0.0001 ***: p<0.001, **: p< 0.01

	All MG n=27	AchR n=19	Musk n=4	SN n=2
MGFA PIS at six months				
MGFA PIS I or better (n, %)	22/27 (81,4%)	17/19 (89,4%)	2/4 (50%)	0/2 (0%)
MGFA PIS PR (n, %)	5/27 (18,5%)	3/19 (15,7%)	2/4 (50%)	0/2 (0%)
MGFA PIS at twelve months				
MGFA PIS I or better (n, %)	18/20 (90%)	14/15 (93%)	2/3 (66,6%)	NR
MGFA PIS CSR or PR (n, %)	7/20 (35%)	5/15 (33,3%)	2/3 (66,6%)	NR

Table 1: MGFA PIS score at sixth and twelve months after Rituximab introduction. AchR: Acetylcholine receptor, SN: Seronegative; CSR: Complete stable remission, PR: pharmacologic remission, I: Improved

Conclusion: Our study corroborated the efficacy and safety of Rituximab. Some complementary studies are necessary to confirm the place of Rituximab in pharmacopeia of MG treatment and to establish the recommendations of infusion protocol.

Disclosure: Nothing to disclose

EPR1180

Botulism: description of a potential life-threatening micro epidemic in 5 families

J. Equiza¹, D. Campo-Caballero¹,
J. Rodriguez-Antigüedad¹, P. Iruzubieta¹, J. Echevarria²,
M.A. Urtaun¹

¹Neurology, University Hospital Donostia, San Sebastian, Spain, ²Microbiology, University Hospital Donostia, San Sebastian, Spain

Background and aims: Botulism is a presynaptic disorder of the neuromuscular transmission produced by the neurotoxin elaborated by the bacterium *Clostridium botulinum*, which can be acquired by contaminated food, infected wounds or iatrogenic. Despite being a potentially life-threatening disease, its presentation can consist on mild complaints.

Methods: Description of a case series.

Results: We describe the clinical course of 14 persons, members of 5 different families, that were exposed to home-canned tuna. 9 of these persons suffered from dry mouth during the next days. Patient ages ranged from 16 to 87 years. Onset of symptoms ranged from 1 to 4 days after the exposure. 7 patients also referred other symptoms such as blurred vision, diplopia, ptosis, dysphagia, facial weakness and/or gastrointestinal symptoms and were admitted to the Neurology department.

The 3 more symptomatic patients were transferred to the Intensive Care Unit in order to administrate heptavalent botulinum antitoxin. Electromyogram was performed to one patient showing a slight presynaptic dysfunction of the neuromuscular junction. Serum and/or stool samples were sent to the National Centre of Microbiology, without detection of neurotoxin. 2 samples of the suspected food source were also analysed, and neurotoxin was detected by mouse bioassay. All the patients remained stable and are completely recovered.

Conclusion: Botulism is a rare but life-threatening disease and a high level of suspicion is needed for making the presumptive diagnosis, specially when only prodromal or unspecific symptoms are present. Treatment with antitoxin may not be necessary in very mild cases with low toxin intake.

Disclosure: Nothing to disclose

EPR1181

Impact of spasticity and waning of effect of Botulinum Toxin A treatment on patients' employment and quality of life: results of a multinational online survey

A. Esquenazi¹, J. Jacinto², P. Varriale³, E. Pain³,
A. Lysandropoulos⁴

¹MossRehab & Albert Einstein Medical Center, Elkins Park, PA, USA, ²Centro de Medicina de Reabilitação de Alcoitão, Serviço de Reabilitação de adultos Estoril, Portugal, ³Carenity, Paris, France, ⁴Ipsen Pharma, Cambridge MA, USA

Background and aims: The aim of this survey was to present the self-reported impacts of spasticity and of waning of effect of BoNT-A treatment on patients.

Methods: An Internet-based survey was conducted through Carenity, an online patient community, in France, Italy, UK, Germany and the USA, from May to September 2019. Adult patients and/or caregivers of patients experiencing spasticity due to a stroke, traumatic brain injury (TBI) or spinal cord injury (SCI), having received ≥ 2 previous BoNT-A injections, currently treated with BoNT-A or having stopped BoNT-A treatment in the last 12 months were eligible.

Results: 210 respondents (mean age 47.2 years, 52.9% male) included. Overall, 42.9% of patients had spasticity due to stroke, 30.0% due to TBI, and 27.1% due to SCI.

Symptoms and areas of life impacted by the condition in the past 12 months are listed in Table 1. 82.9% of patients experienced the reappearance of spasticity-related symptoms between 2 BoNT-A injections. Stiffness/rigidity (74.1%) was the most reported recurring symptom. 46.6% of them had to take time off from work due to recurring symptoms. To avoid recurring symptoms, 72.2% reported wishing injections with longer-lasting effect.

The intensity of spasticity-related symptoms on patients' QoL varied between 2 BoNT-A injections: it was strongest on the day before the next session. (Table 2). The impact of spasticity on patients' Quality of Life (QoL) evolved similarly (Table 3).

Symptoms most experienced*	Overall (N=210)
Symptoms experienced by patients; n (%)	
Muscle stiffness/rigidity (including painful cramps)	148 (70.5)
Muscle spasms	132 (62.9)
Muscle pain	108 (51.4)
Difficulties moving my leg, falling, tripping, loss of balance	104 (49.5)
Unwanted movement of the affected limb	86 (40.9)
Areas of life impacted by the condition; n (%)	
Loss of self-confidence	110 (52.4)
Depression	96 (45.7)
Lack of sleep	86 (40.9)

*symptoms and conditions with frequencies >40%.

Table 1: Symptoms and areas of life impacted by the condition in the past 12 months*

	Intensity of the symptoms reappearing between two sessions of BoNT-A injections (N=174)		
	At peak treatment effect	When pre-existing symptoms start reappearing	1 day before next BoNT-A injection
Muscle stiffness/rigidity (including painful cramps) (n=129)	1.7	4.2	6.8
Muscle spasms (n=112)	1.5	4.3	6.6
Muscle pain (n=92)	1.6	4.2	6.7
Difficulties moving my leg, falling, tripping, loss of balance (n=85)	1.5	4.2	7.0
Unwanted movement of the affected limb (n=68)	1.6	4.1	6.6
Difficulties moving my arm/hand (n=56)	2.4	4.6	6.5

*mean scores out of 10: 0=no symptom, 10=very strong symptom.

Table 2: Patients' perception of the intensity of the symptoms reappearing between 2 sessions of BoNT-A injections*

	Impact of the symptoms reappearing between two sessions of BoNT-A injections (N=174)		
	At peak treatment effect	When pre-existing symptoms start reappearing	1 day before next BoNT-A injection
Ability to move around	1.9	4.2	6.5
Ability to perform daily tasks	1.8	4.2	6.4
Self-confidence	1.9	4.1	6.4
Lack of sleep/fatigue	1.7	4.0	6.3
Relationship with family and friends	1.6	3.8	6.0

*mean scores out of 10: 0=no impact, 10=very strong impact.

Table 3: Patients' perception of the impact of the symptoms reappearing between 2 sessions of BoNT-A injections on QoL*

Conclusion: Spasticity and the waning effect of BoNT-A injections impacts multiple aspects of patients' life, particularly self-confidence and ability to move around and to work.

Disclosure: This study was funded by Ipsen Pharma

EPR1182

Long-term outcomes in 50 patients with idiopathic inflammatory myopathies (IIM) and role of myositis-specific antibodies

M. Ferraro, S. Bortolani, G. Gadaleta, E. Rolle, C. Brusa, M. Vacchetti, T.E. Mongini

Department of Neurosciences "Rita Levi Montalcini", University of Torino, Italy, Turin, Italy

Background and aims: IIM are the largest group of acquired and potentially treatable myopathies. 4 major distinct subsets are recognized: dermatomyositis (DM), polymyositis (PM), immune mediated necrotizing myopathy (NM) and inclusion-body myositis (IBM). Myositis-specific autoantibodies (MSAs) have an increasing role to identify subgroups with different treatment response and prognosis. Aim of the study was to correlate clinical characteristics and long term outcomes in 50 patients with IIM followed at Neuromuscular Center in Torino in the last 10 years

Methods: Diagnosis was established according the EMNC criteria, and included PM, DM and NM patients. MSAs were tested in all patients by commercial immunoassay. Therapy protocols included prednisone, Ig ev, azathioprine and/or rituximab. Mean follow up was 5 years.

Results: MSAs were positive in 27 patients (54%); anti-Jo1 Ab were positive in 9 patients (33%), followed by anti-HMGCR (18%), anti-SRP (15%) and anti-Mi2 (15%). The remaining patients were equally distributed with anti-Ku, anti-PM Scl-75, anti-TIF1-gamma, anti-NXP2 Ab.

Patients anti-Jo1 positive tended to a worse long-term prognosis; 1 severely affected patient responded positively only to rituximab. All anti-HMGCR positive cases had a NM, promptly responding to Ig ev therapy. Anti-SRP positive patients had a rapid, severe generalized course of NM, with complete remission with rituximab. All patients with anti-Mi2 positivity had a DM, responding completely to prednisone therapy. Seronegative patients responded more variably to prednisone and azathioprine and/or Igev.

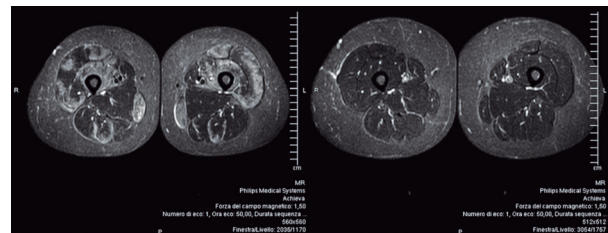

Skeletal Muscle NMR of patient with ab anti-jo-1 pre e post Rituximab

Conclusion: MSAs have an important role in defining subgroups of patients with IIM, indicating different specific therapeutic approaches as a first choice, resulting in complete remission in most cases.

Disclosure: Nothing to disclose

EPR1183

Bioimpedance analysis (BIA), dual energy X-ray absorptiometry (DEXA) and nutritional characteristics in myotonic dystrophy type 2 (DM2) patients

E. Frezza¹, M. Cintoni², G. Pulcini², G. Greco³, C. Palombi³, G. Tammam³, M. Salvia³, A. De Lorenzo⁴, R. Massa¹

¹Rome, Italy, ²Post-doctoral program in nutrition Science, Tor Vergata University of Rome, Rome, Italy, ³Department of Systems Medicine, Tor Vergata University of Rome, Rome, Italy, ⁴Department of Biomedicine and Prevention, Tor Vergata University of Rome, Rome, Italy

Background and aims: Metabolic alterations are an important feature of DM2; therefore, recognition of changes in body composition by BIA and its correlation with other disease features might be useful as disease severity index.

Methods: We obtained anthropometric measures, nutritional data, BIA, DEXA, and blood tests in 18 DM2 patients and correlated with motor function tests including: 30-SCT, FI-2 and QMFT. BIA parameters were matched for age, sex, and BMI with healthy control volunteers. Descriptive statistics, Pearson's correlation coefficient and linear regression were performed.

Results: Waist circumference was above normal values in 100% of women and 78% of men. Based on body mass index (BMI), 66% of women and 89% of men were overweight or obese. Mineralization of bone by DEXA showed normal values in most of patients. PA was reduced in 61% of patients and showed direct correlation with 30SCT, FI-2 flexion and abduction test, and QMFT. Bia-derived fat mass (FM) was increased in 22% of women and 56% of men, fat-free mass (FFM) was reduced respectively in 33.3% and 78%. A direct correlation of BCMI with FI-2 flexion and abduction and of BMI with HOMA index ($p < 0.001$) was also found. PA was lower in DM2 compared to controls ($p < 0.05$).

Conclusion: This pilot study shows that an alteration in the relative prevalence of FFM versus FM, as suggested by reduction of PA is a common feature of DM2 and parallels motor function tests impairment. Therefore, further studies on larger cohorts and with a prospective approach could validate BIA as an outcome measure for DM2.

Disclosure: Nothing to disclose

EPR1184

Comparison of the diagnostic accuracy of the ice-pack test and single fiber EMG in patients with ocular myasthenia

M.P. Giannoccaro¹, M. Paolucci², V. Di Stasi¹, C. Zenesini¹, V. Donadio¹, P. Avoni¹, R. Liguori¹
¹IRCCS Institute of Neurological Sciences, Bologna, Italy, ²Rome, Italy

Background and aims: Single-fiber EMG (SF-EMG) is considered highly sensitive for the diagnosis of ocular myasthenia (OM), but it is not widely available. On the contrary, the ice-pack test (IPT) can be easily performed in an ambulatorial setting. However, no studies compared the diagnostic yield of ice-pack test and SF-EMG in a large population. Therefore, we aimed at comparing the diagnostic accuracy of these tests in patients with suspected OM presenting with ptosis.

Methods: We studied consecutive patients referred for the clinical suspicion of OM. Patients underwent stimulation SF-EMG on the orbicularis oculi muscle and the ice-pack test. ROC curve analysis was performed to determine the accuracy of IPT, SF-EMG and their combination.

Results: We included 155 patients, 102 OM and 53 with other diagnosis (OD). The IPT had a sensitivity of 86% and a specificity of 79%. SF-EMG showed a sensitivity of 94% and a specificity of 79%. Overall, IPT and SF-EMG showed discordant results in 30 cases, 16OM and 14OD. The combination of ice-pack test and SF-EMG, using the positivity of at least 1 test for OM diagnosis, increased the sensitivity to 98% reducing the specificity to 66% whereas using the positivity of both tests we obtained a sensitivity of 82% and a specificity of 92%. Comparison of the AUCs showed no differences in the diagnostic accuracy of IPT, SF-EMG and their combinations.

Conclusion: IPT and SF-EMG have a similar diagnostic accuracy in patients with OM presenting with ptosis. The negativity of both tests strongly suggests another diagnosis.

Disclosure: Nothing to disclose

EPR1185

Longer-term Nusinersen Treatment According to Age at First Dose: Results From the SHINE Study in Later-onset Spinal Muscular Atrophy

W. Mueller-Felber¹, B.T. Darras², C.A. Chiriboga³, M.A. Farrar⁴, E. Mercuri⁵, J. Kirschner⁶, N.L. Kuntz⁷, G. Acsadi⁸, M. Tulinius⁹, J. Montes¹⁰, G. Gambino¹¹, R. Foster¹¹, D. Ramirez-Schrempp¹², J. Wong¹², B. Kandinov¹², W. Farwell¹²

¹Department of Neuropediatrics, Developmental Neurology and Social Pediatrics, University of Munich, LMU-Campus Innenstadt, Munich, Germany, ²Department of Neurology, Boston Children's Hospital, Boston, MA, USA, ³Departments of Neurology and Pediatrics, Columbia University Irving Medical Center, New York, NY, USA, ⁴Paediatric Neurology, Sydney Children's Hospital and UNSW Sydney, Randwick, Australia, ⁵Department of Paediatric Neurology, University Cattolica del Sacro Cuore, Rome, Italy, ⁶Department of Neuropaediatrics, University Hospital Bonn, Bonn, Germany, ⁷Division of Neurology, Ann & Robert H. Lurie Children's Hospital of Chicago, Chicago, IL, USA, ⁸Division of Pediatric Neurology, Connecticut Children's Medical Center, University of Connecticut School of Medicine, Farmington, CT, USA, ⁹Department of Pediatrics, Gothenburg University, The Queen Silvia Children's Hospital, Gothenburg, Sweden, ¹⁰Departments of Rehabilitation and Regenerative Medicine and Neurology, Columbia University Irving Medical Center, New York, NY, USA, ¹¹Biogen, Maidenhead, Berkshire, United Kingdom, ¹²Biogen, Cambridge, MA, USA

Background and aims: SHINE is an open-label extension study (NCT02594124) for participants who completed previous nusinersen trials.

Methods: These analyses focus on participants with later-onset SMA who received nusinersen or sham procedure in the Phase 3 CHERISH study and transitioned to SHINE. Following a protocol amendment, all participants receive nusinersen 12mg every 4 months in SHINE. Motor function data (15 October 2018 interim analysis) were analyzed in three groups by age at first nusinersen dose (≥ 2.0 to < 3.5 years [n=35]; ≥ 3.5 to < 5.0 years [n=41]; ≥ 5.0 to < 9.5 years [n=34]) in participants reassessed for CHERISH inclusion criteria with a value windowed to Day 690 regardless of treatment group.

Results: At SHINE Day 690, the mean [SD] change in HFMSE total score from baseline improved in those youngest at first dose (+8.9 [5.7]), improved then stabilized in those of intermediate age (+3.1 [4.3]) and stabilized in children who were older at first dose (-2.1 [4.2]). The mean (SD) change from baseline to Day 690 in RULM total score also improved over time in those who were youngest (+8.0 [5.1]) or of intermediate age (+3.6 [3.3]) at 1st dose, and was stable in those older at 1st dose (+0.5 [2.9]). The youngest participants at 1st dose achieved the most gains in WHO motor milestones. Data from the 2019 SHINE interim analysis for these participants and those who transitioned from CS2/12 and EMBRACE will be presented.

Conclusion: Among individuals with later-onset SMA, the youngest participants at first dose of nusinersen showed the greatest improvement in motor function.

Disclosure: This study was sponsored by Biogen (Cambridge, MA, USA). Writing and editorial support for the preparation of this abstract was provided by Excel Scientific Solutions (Fairfield, CT, US); funding was provided by Biogen.

Neuroimaging 1

EPR1186

Transcranial ultrasound in HIV infection: does it reflect infectious and neurological symptoms?

A. Alonso Cánovas¹, J. Martínez Poles¹, M.J. Pérez-Eliás², J.L. Casado³, A. Moreno³, C. Quereda⁴, E. Navas Elorza², F. Dronda³, M.J. Vivancos³, S. Moreno Guillen³, J. Masjuan⁵, J.C. Martinez-Castrillo⁶, Í. Corral⁵

¹Neurology, Hospital Ramón y Cajal, Madrid, Spain, ²Infectious Diseases, Hospital Ramón y Cajal, Madrid, Spain, ³Infectious Diseases, Hospital Universitario Ramón y Cajal, Madrid, Spain, ⁴Infectious Diseases, Hospital Universitario Ramón y Cajal, Madrid, Spain, ⁵Neurology, Hospital Universitario Ramón y Cajal, Madrid, Spain, ⁶Neurology, Hospital Universitario Ramón y Cajal, Madrid, Spain

Background and aims: HIV associates an increased frequency of neurological symptoms due to the infection itself and immunosuppression. Transcranial ultrasound (TUS) depicts abnormalities in substantia nigra (SN), 3rd ventricle (3V) and basal ganglia (BG), useful for parkinson's disease diagnosis. A former study found an association among SN hyperechogenicity and motor performance in 40 HIV patients.

Methods: Transversal study of consecutive outpatient HIV subjects with neurological (UPDRSIII and International HIV dementia scale) and TUS assessment, with a sample of 132 historic control subjects for comparison of ultrasound variables (Figure1).

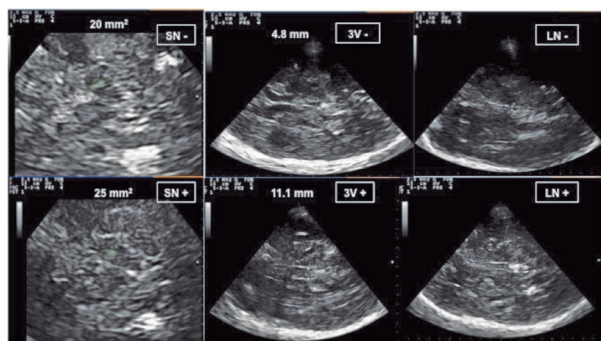

Figure 1

Results: 123 subjects (80% male, 43±13 years old, 15±12 years of HIV infection, 32% with CD4 nadir <200, 25% fulfilling AIDS criteria, 26% HCV co-infection) were included in a 6-days period. 7 had history of neurological complications (3 stroke, 2 HIV encephalitis, 2 toxoplasmosis, 1 multifocal progressive leukoencephalopathy, 1 varicella-zoster encephalitis). 19 subjects scored <11 in I-HIV-DS and 10 (4%) over 5 in UPDRSIII: the latter was associated with AIDS diagnosis and lowest CD4 nadir (Figure2). Among 115 (93%) with sufficient transtemporal bone window, 19 had SN hyperechogenicity (17% vs. 11%

controls, NS), 7 3V enlargement (6% vs. 5%, NS) and 31 BG hyperechogenicity (30% vs. 9%, p=0.00043), without association with any infectious or neurological clinical variable (Figure 3). MRI was available in 4 cases with BG hyperechogenicity and was abnormal in all them.

	UPDRS III			p	HIVDS			p
	Normal	Mild	Mod/Sev		Normal	Borderline	Abnormal	
AIDS +/-	18%/82%	29%/71%	70%/30%	0.0018	23%/77%	22%/78%	42%/58%	NS
CD4 Nadir								
>500	23%	15%	0%	0.0101	25%	17%	5%	NS
200-500	49%	48%	10%		41%	50%	47%	
<200	28%	36%	90%		33%	33%	47%	

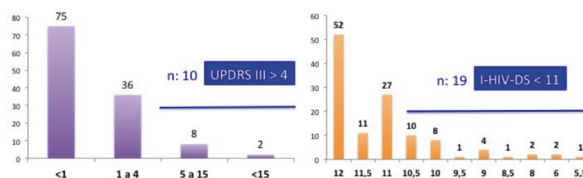

Figure 2

	SN hyperechogenicity (n:19)		Basal Ganglia hyperechogenicity (n:25)	
Male/Female	18%/9%	NS	27%/12%	NS
AIDS yes/no	22%/15%	NS	20%/25%	NS
Hepatitis C yes/no	17%/17%	NS	24%/23%	NS
CD4 Nadir				
>500	18%	NS	32%	NS
200-500	18%		22%	
<200	16%		19%	
Drug abuse yes/no	17%/17%	NS	23%/24%	NS
HIVDS				
NORMAL	12%	NS	20%	NS
BORDERLINE	24%		33%	
ABNORMAL	12%		12%	
UPDRS III				
NORMAL	20%	NS	30%	NS
MILD	13%		10%	
MODERATE-SEVERE	11%		22%	

Figure 3

Conclusion: SN hyperechogenicity was not more frequent in HIV+ than in control subjects, unlike previous evidence suggested. Conversely, an increased prevalence of BG hyperechogenicities of unknown significance, previously not described, was found.

Disclosure: Nothing to disclose

EPR1187

Microstructural tissue changes in Alzheimer's disease: insights from Magnetization Transfer Imaging

I. Colonna¹, M. Koini¹, L. Pirpamer¹, A. Damulina², A. Lechner², E. Hofer², R. Schmidt², S. Ropele²

¹Medical University of Graz, Graz, Austria, ²Neurology, Medical University of Graz, Graz, Austria

Background and aims: Reductions of the magnetization transfer ratio (MTR), a magnetic resonance imaging-derived measure, has been associated with microstructural damage of the brain. Recent studies have demonstrated global MTR reductions in Alzheimer's disease (AD), but regional changes and their associations with cognition are less explored. In this study, we therefore assessed MTR in the grey matter (GM) and in normal appearing white matter (NAWM) in patients with AD and in normal elderly. Additionally, we analyzed the relationship between MTR and cognitive functioning.

Methods: 77 patients with moderate AD (mean±SD age=72.03±7.71) and 77 age-matched (±1 year) controls underwent clinical and MRI examination at 3 Tesla. Cognitive performance was assessed in the patients only and included MMSE and CERAD. The MTR was assessed regionally in the cortex, NAWM, hippocampus, and deep gray matter structures.

Results: MTR reductions in AD patients were global and were found in the hippocampus, deep gray matter, cortex, white matter hyperintensities (WMH) and in the NAWM. After correction for atrophy AD patients had lower MTR values in the occipital lobe and in NAWM than controls. Reduced MTR values in the cortex, NAWM, Globus pallidus and hippocampus were associated with a worse performance on MMSE and on CERAD subtests for constructional praxis, object naming, verbal memory and cognitive flexibility, independent of atrophy, age, sex and WMH volume.

Conclusion: The MTR allows to assess AD related tissue changes of the brain. A decrease of MTR in cortical structures and NAWM contributes to cognitive impairment beyond atrophy.

Disclosure: Nothing to disclose

EPR1188

Longitudinal analysis of brain iron in Alzheimer's disease

A. Damulina, C. Langkammer, L. Pirpamer, M. Soellradl, M. Sackl, E. Hofer, C. Tinauer, C. Enzinger, S. Ropele, R. Schmidt

Department of Neurology, Medical University of Graz, Graz, Austria

Background and aims: Recent studies have demonstrated higher iron concentrations in patients with Alzheimer's disease (AD) compared to healthy controls. However, to our knowledge, to date, no published study has examined the relationship between the longitudinal iron change in the neocortex and cognitive decline in AD. We aimed to investigate using R2* relaxation rate mapping the association between longitudinal changes in R2* and cognition in patients with AD.

Methods: Our study included 57 participants with AD from the Prospective Dementia Registry Austria study (mean age 71.4±9.4 years, men/women=26/31). All study participants underwent longitudinally subsequent neuropsychological and neuroimaging assessment with an MRI protocol at 3 Tesla identical between baseline and follow-up, including R2* relaxation rates mapping, corrected for macroscopic field variations, with a mean follow-up time of 17 months. Anatomical structures were segmented and median R2* rates were calculated in the neocortex and cortical lobes, the basal ganglia, hippocampi and thalami.

Results: R2* in parietal lobe decreased whereas R2* relaxation rates of global basal ganglia, putamen, caudate nucleus and thalamus increased over time (Table 1). R2* change in the temporal and occipital lobes, after adjustment for change in brain volume over the observational period, correlated significantly with change in cognition over 17 months ($\beta=-0.31$, $p=0.02$, $\beta=-0.34$, $p=0.01$, respectively) (Table 2).

Table 1. Annualized percentage rates of R2* levels in study participants with Alzheimer's disease after 17 months follow-up

Region	R2* annualized rate	
	median (%)	p value*
Total cortex	-0.13	0.28
Global basal ganglia	1.48	<0.01
Frontal lobe	-0.02	0.61
Temporal lobe	0.31	0.63
Parietal lobe	-0.68	0.04
Occipital lobe	0.66	0.32
Caudate nucleus	1.94	0.01
Globus pallidus	1.07	0.03
Putamen	1.07	<0.01
Hippocampus	-1.18	0.27
Thalamus	0.83	0.05

*computed using Wilcoxon Signed Ranks Test

Table 2. The association between annualized R2* and MMSE changes in study participants with Alzheimer's Disease

Annualized R2* change	Annualized MMSE change		
	Multivariable regression, corrected for age and annualized change of regional volumes		
	β	p value	95% CI
Total cortex	-0.19	0.16	-2.97; 0.50
Global basal ganglia	0.02	0.89	-0.39; 0.45
Frontal lobe	-0.10	0.43	-2.24; 0.96
Temporal lobe	-0.31	0.02	-2.44; -0.27
Parietal lobe	-0.04	0.79	-1.14; 0.88
Occipital lobe	-0.34	<0.01	-2.25; -0.37
Caudate nucleus	-0.07	0.57	-0.50; 0.28
Globus pallidus	<0.01	0.99	-0.28; 0.29
Putamen	0.07	0.64	-0.28; 0.44
Hippocampus	-0.25	0.07	-0.93; 0.03
Thalamus	0.10	0.47	-0.69; 1.47

β = regression coefficient; CI = confidence interval, MMSE = Mini-Mental State Examination.

Conclusion: Our results demonstrate that an iron increase in the temporal and occipital lobes correlated with cognitive decline. These findings support the view that impaired iron homeostasis may be involved in the pathophysiology of AD.

Disclosure: Nothing to disclose

EPR1189

Functional brain connectome in drug-naïve Parkinson's disease patients

R. De Micco¹, F. Agosta², S. Basaia², M. Siciliano¹, C. Cividini², G. Tedeschi¹, A. Tessitore¹, M. Filippi²

¹Department of Medical, Surgical, Neurological, Metabolic and Aging Sciences, University of Campania "Luigi Vanvitelli", Naples, Italy, ²Neuroimaging Research Unit, Institute of Experimental Neurology, Division of Neuroscience, San Raffaele Scientific Institute, Vita-Salute San Raffaele University, Milan, Milan, Italy

Background and aims: Graph analysis may be applied to characterize functional architecture changes related to Parkinson's disease (PD) development and progression.

Methods: 147 drug-naïve PD patients underwent motor, non-motor and neuropsychological assessments as well as resting-state functional MRI at baseline. 38 age- and sex-matched controls were also enrolled. Non-hierarchical cluster analysis using clinical data were applied to stratify PD patients in 2 subtypes: 77 patients were grouped as "early/mild" and 70 as "early/severe". Graph analysis and connectomics assessed global and local topological network properties and regional functional connectivity (FC) at baseline in both PD patients and controls. Multivariate regressions were used to investigate whether functional imaging data at baseline were predictors of clinical impairment over a 2-year period.

Results: At baseline, widespread FC abnormalities were detected in several networks encompassing basal ganglia, sensorimotor and occipital areas in PD patients compared to controls. Moreover, decreased FC involving mainly striato-frontal, striato-temporal and limbic connections differentiated "early-mild" from "early-severe" PD patients. "Early/mild" PD patients showed a preserved global functional brain architecture compared to controls. FC abnormalities at baseline were found to be an independent predictor of cognitive outcome and levodopa requirement over 2 years.

Conclusion: Our findings revealed that a specific subtype of PD patients, characterized by severe motor and non-motor burden as well as widespread FC abnormalities, may be identified at the time of diagnosis. We hypothesize that this pattern may reflect the presence of more diffuse neuropathological changes. Combined clinical and neuroimaging tools are promising to stratify risk of PD progression overtime.

Disclosure: Nothing to disclose

EPR1190

Resting state functional MRI improves outcome prediction in middle cerebral artery stroke

D. Pinter¹, T. Gattringer², S. Fandler-Höfler², M. Kneihsl², S. Eppinger², H. Deutschmann³, S. Horner², B. Poltrum², G. Reishofer³, S. Ropele⁴, C. Enzinger¹

¹Research Unit for Neuronal Plasticity & Repair, Medical University of Graz, Graz, Austria, ²Department of Neurology, Medical University of Graz, Graz, Austria, ³Department of Radiology, Medical University of Graz, Graz, Austria, ⁴Neurology, Medical University of Graz, Graz, Austria

Background and aims: Resting-state functional MRI (rfMRI) has been suggested to improve prediction of post-stroke recovery. We assessed whether rfMRI improves outcome prediction in addition to conventional predictors after acute stroke.

Methods: We assessed 56 patients (mean age 64 years, 38% female, median admission NIHSS 9.5) with MRI-confirmed middle cerebral artery infarction who have received intravenous thrombolysis and/or mechanical thrombectomy at the acute stage (24-72 hours after symptom onset) and at 3 months follow-up. Outcome was assessed by the modified Rankin Scale (mRS) score at follow-up. MRI data of 6 patients had to be excluded due to severe motion artefacts or lesion-related registration errors. We used an ordinal regression model including demographics, clinical scores, lesion size, whole brain white matter integrity assessed by DTI and functional connectivity of the ipsilesional primary motor area (FC iM1) to identify outcome predictors.

Results: At follow-up, 20 patients had mRS 0 (35.7%), 21 patients (37.5%) had mRS 1, 8 patients (9.6%) mRS 2 and 7 patients (8.4%) mRS 3 or 4. Spearman correlations showed that NIHSS at baseline ($r=0.65$), lesion volume ($r=0.47$), whole brain white matter integrity ($r=-0.40$), and FC of iM1 ($r=0.42$) were associated with mRS scores at follow-up. Although NIHSS at baseline was the strongest independent predictor of mRS scores at follow-up (Nagelkerke=44.2%), baseline FC of iM1 improved prediction to 62.4%.

Conclusion: RfMRI improves prediction of outcome in a homogeneous group of acute stroke patients. Early changes in FC might be a promising biomarker for post-stroke outcome.

Disclosure: Nothing to disclose

EPR1191

The interpretation of brain CT scans throw direct analysis and via WhatsApp: Moroccan experience

K. Haddouali¹, I. Ferrassi², A. Mouhdi², S. Bellakhdar², B. El Moutawakil², M.A. Rafai², H. El Otmani²

¹CASABLANCA, Morocco, ²Department of Neurology and Neurophysiology, Ibn Rochd University Hospital, Casablanca, Morocco

Background and aims: The use of smartphones in medical practice (telemedicine) is becoming more and more widespread. Ischemic strokes, eligible for thrombolysis, are one of many disorders having benefited from this technology for a proper and quicker management. The aim of this study is to evaluate intra and inter-individual interpretation of brain CT scans, analysed directly and those shared via WhatsApp, in order to assess the reliability of this tool.

Methods: A double-blind cross-sectional study was conducted, including neurology residents, of the Ibn Rochd university hospital, having completed at least 2 years of residency. These doctors were asked to estimate the ASPECT (Alberta Stroke Program Early CT) Score using 2 different methods: throw a direct analysis or via WhatsApp shared images.

The scans of 30 patients treated using intravenous thrombolysis, between 2018 and 2019, were randomly selected and both, a sender and receiver, high image-resolution smartphones were implemented for this task.

Results were analysed using an SPSS software.

Results: 7 doctors, with a mean residency length of 42 months, completed the study. Intra-individual results (WA versus direct analysis scores) were consistent in 71% of cases ($n=5$, $p<0.05$) with a maximum correlation of $R=0.44$. Results were identical between residents and professors in 85% of cases ($n=6$, $p<0.05$).

Conclusion: The use of WA in brain CT scan analysis seems highly reliable. Larger studies would probably be of great interest.

Disclosure: Nothing to disclose

EPR1192

Prognostic value of 18F-FDG PET in unresponsive wakefulness syndrome patients.

E. Kondratyeva¹, S. Kondratyev², D. Ryzhkova³, N. Ivanova⁴

¹Saint Petersburg, Russian Federation, ²Intensive Care, Almazov National Medical Research Centre, Saint-Petersburg, Russian Federation, ³PET-center, Almazov National Medical Research Centre, Saint-Petersburg, Russian Federation, ⁴Neurology Department, Almazov National Medical Research Centre, Saint-Petersburg, Russian Federation

Background and aims: The diagnostic and prognostic usefulness of neuroimaging-based approaches has not been established in a clinical setting. We did a validation study of FDG PET imaging in prognosis VS/UWS

Methods: 18F-FDG PET was performed in 172 patients DOC patients between 2006-2018. Outcomes were assessed 12 months after TBI and 6 months after hypoxia. 109 patients after TBI and 63 with hypoxia: UWS 77 patients, MCS + 62 patients, MCS – 34 patients, mean age 28 y.o. Duration of DOC was 1-6 months in TBI and 4 months in hypoxic brain damage.

Results: Prognostically favorable for further recovery of consciousness were following findings: preservation of glucose metabolism in the cortical regions above 45% of the cerebellar metabolism level, in particular, preservation of the 18F-FDG metabolism at the level above 50% of the cerebellar metabolism level in the frontal and parietal lobes indicated the possibility of transition from UWS to MCS in patients with both traumatic and non-traumatic brain damage. Correlation was found between the outcome of UWS (CRS-R score) and the level of metabolism in the brain stem. All studies were conducted at the level of significance. Correlation analysis showed that the greatest importance in predicting of the UWS outcome (CRS_R score) was the preservation of the 18F-FDG metabolism in the cortex of the frontal, parietal, temporal and occipital lobes of the right hemisphere, brain stem.

Conclusion: Cerebral (18)F-FDG PET could be used to complement bedside examinations and predict long-term recovery of patients with unresponsive wakefulness syndrome.

Disclosure: The study was funded by RFBR (Russian Foundation for Basic Research) project number 19-29-01066/2019

EPR1193

Brain Microstructural Changes in CADASIL

N. Kurochkina¹, A. Moroz², R. Konovalov¹, Z. Gadzhieva², M. Krotenkova¹, S. Illarionov²

¹Radiology, Research Center of Neurology, Moscow, Russian Federation, ²Research center of Neurology, Moscow, Russian Federation

Background and aims: Cerebral autosomal dominant arteriopathy with subcortical infarcts and leukoencephalopathy (CADASIL) is the most common hereditary monogenous form of cerebral small vessel disease (SVD). The aim of this study was to evaluate the spatial distribution and features of brain microstructural changes, associated with CADASIL.

Methods: We enrolled 105 patients with genetically confirmed CADASIL (40), hypertensive microangiopathy, multiple sclerosis and 34 healthy control. Patients were evaluated with different clinical scales. The conventional MRI and DTI with calculation of fractional anisotropy (FA), mean (MD), axial (AD) and radial (RD) diffusivity maps were performed. Brain tissue lesions were assessed using Standards for Reporting Vascular changes on neuroimaging (STRIVE). Voxel-wise group analysis was carried out using SPM12 software and also ROI analysis was carried out to study the white matter microstructure.

Results: In CADASIL group MRI shows all the types of SVD signs: recent small subcortical infarcts, lacunes, white matter hyperintensities (WMH), perivascular spaces and microbleeds. Whole-brain and ROI analysis of diffusivity maps in CADASIL patients revealed dramatic changes in white matter (WM) both in regions of WMH and normal appearing WM (Fig. 1). The FA was decreased and MD, AD and RD were increased in all ROI.

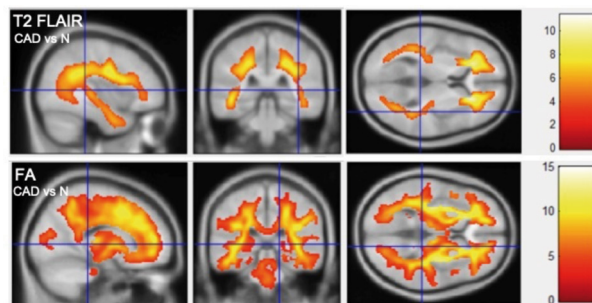

Between-group analysis showing areas of WMH (top) and significantly decreased FA (bottom) in patients with CADASIL as compared to healthy controls.

Conclusion: Neuroimaging signs of brain lesions are common for all types of cerebral small vessel disease, including CADASIL. However, the distribution of WMH and patterns of microstructural changes specify the differences observed in CADASIL. These changes correspond more to demyelination but differ between the anatomical regions and need the further studies.

Disclosure: Nothing to disclose

EPR1194

Lesion distribution and substrate in Type 1 Myotonic Dystrophy: comparison with Multiple Sclerosis

S. Leddy¹, L. Serra², D. Esposito³, C. Vizzotto⁴, G. Silvestri⁵, A. Petrucci⁶, G. Meola⁷, M. Cercignani¹, M. Bozzali⁸

¹Neuroscience, University of Sussex, Brighton, United Kingdom, ²Neuroimaging Laboratory, IRCCS Santa Lucia Foundation, Rome, Italy., ³Department of Vascular and Endovascular Surgery, University of Florence, Florence, Italy, ⁴IRCCS Santa Lucia Foundation, Rome, Italy, ⁵Neurology, Fondazione Policlinico Universitario A. Gemelli IRCCS, Rome, Italy, ⁶Neurology Unit, San Camillo Forlanini Hospital, Rome, Italy, ⁷San Donato Milanese (MI), Italy, ⁸Neuroscience, Brighton and Sussex University Hospital, Brighton, United Kingdom

Background and aims: A typical feature of type 1 Myotonic Dystrophy (DM1) is the presence of widespread white matter lesions. This study compares the lesion distribution and substrate between patients with DM1 and patients with Multiple Sclerosis (MS).

Methods: 28 patients with DM1, 29 patients with relapsing remitting MS, and 15 healthy controls had an MRI scan, including FLAIR quantitative magnetization transfer (qMT) imaging. Lesions were outlined on FLAIR; qMT data were processed to compute the pool size ratio (F), known to correlate with myelin content. The average F was computed within lesions and normal appearing white matter (NAWM) for every participant. The lesion masks were warped into MNI space and lesion probability maps were obtained for each patient group. The total lesion load, and the tissue-specific mean F were compared between groups.

Results: The mean lesion volume was higher in MS than DM1. DM1 presented higher prevalence of anterior temporal lobe lesions, but none in the cerebellum and brainstem. In both patient groups the mean F of lesions was lower than the NAWM ($p < 0.01$, CI 0.06-0.07), but it was lower in MS than DM1 ($p < 0.01$, CI 0.01-0.04). NAWM F did not differ between DM1 and controls.

Conclusion: DM1 show a greater lesion distribution in the temporal lobe regions compared to MS. Using qMT, we demonstrated significantly reduced F values within DM1 lesions, suggesting a loss of myelin density. Nevertheless, the mean F is lower in MS lesions than DM1 lesions, indicating a lesser degree of demyelination in the former.

Disclosure: Nothing to disclose

EPR1195

Possible role of the ONSD in predicting malignant media stroke

P. Lochner¹, K. Fassbender², E.P. Stolz³, A. Gawlitza¹, F. Roell¹, M. Lesmeister¹

¹Neurology, Saarland University Medical Center, Homburg, Germany, ²Homburg/Saar, Germany, ³Neurology, University of Gießen, Gießen, Germany

Background and aims: The prevalence of hemispheric malignant media infarction (mMCA) has been reported to be 2% to 8% of all ischemic stroke. The optic nerve sheath diameter (ONSD) has been demonstrated to be a non invasive assessment for detecting raised intracranial pressure (ICP). We tested whether ONSD measurements could support clinical evaluation to predict occurrence and promptly diagnose of malignant infarction.

Methods: In a single-center prospective observational study we recruited patients with MCA infarction and age- and sex-matched controls. Demographics, clinical characteristics including National Institutes of Health Stroke Scale and ONSD measurement were assessed prospectively upon admission and during the 1st 5 days after symptom onset.

Results: We included 29 patients with MCA infarction, among them 10 developed an mMCA infarction, and 14 controls. ONSD already on admission was larger in patients who had developed an mMCA (mean 5.99mm, (SD) 0.318) compared to patients with MCA infarction (4.98mm, SD 0.532; $P = 0.003$), and to control patients (4.57mm, SD 0.285; $P < 0.001$). Correlation was observed between the largest ONSD and volumetric evaluation of cerebral infarction in the CT scan ($r = 0.757$; $P < 0.001$). An ONSD value of 5.595mm predicted an mMCA with a sensitivity of 100% and specificity of 90% yielding a PPV of 83% and NPV of 100%.

Conclusion: ONSD measurement might be accurate for the noninvasive detection of increased ICP. The serial ONSD measurements could help to detect the deterioration of patients.

Disclosure: Nothing to disclose

EPR1196

Automated brain volumetry at different field strengths - a feasibility study

M. Zidan¹, P. Mann², R. Gnirs³, J.-E. Meissner², D. Paech³, J. Opalka², J. Jesser¹

¹Neuroradiologie, University Hospital Heidelberg, Heidelberg, Germany, ²mediaire GmbH, Berlin, Germany, ³Radiology, German Cancer Research Center, Heidelberg, Germany

Background and aims: Comparability study of quantitative brain volumetry at 1.5T, 3T and 7T

Methods: In this study, brain scans of 7 volunteers (25±5y) were acquired on three Siemens MR Scanners (1.5T-AERA, 3T-PRISMA and 7T-MAGNETOM) using 3D-T1w images (0.5x0.5x0.59mm³, no interpolation). Volumetric measurements were performed with the AI-powered commercial software mbrain from mediaire as it showed high stability for repeated measurements in previous studies and its short calculation time. The evaluation pipeline includes a bias correction accounting for intensity non-uniformities. For statistical evaluation, repeated measures ANOVA was calculated followed by a post-hoc paired t-tests focusing on a selection of seven brain regions (grey-and white-matter (GM, WM), hippocampus, putamen, amygdala, caudate and thalamus)

Results: As rated by a radiologist, images were of good quality for all 3 scanners (Figure1). Except for the hippocampus, the repeated measures ANOVA revealed significant differences between the conditions 1.5T, 3T and 7T (p<0.05). The post-hoc paired t-tests showed significant differences for the 1.5T/3T data versus the 7T data: Volumes of WM and amygdala were decreased by 10% and 5% while caudate was increased by ~4%. Except for the thalamus (~6% decrease), no significant differences between 1.5T and 3T were present (Table1).

Figure 1. Representative axial slices of the same volunteer for different field strengths (1.5T, 3T and 7T). Respective brain volumes are superimposed with the original image, showing grey matter (green), white matter (yellow), putamen (red), caudate (orange) and thalamus (blue).

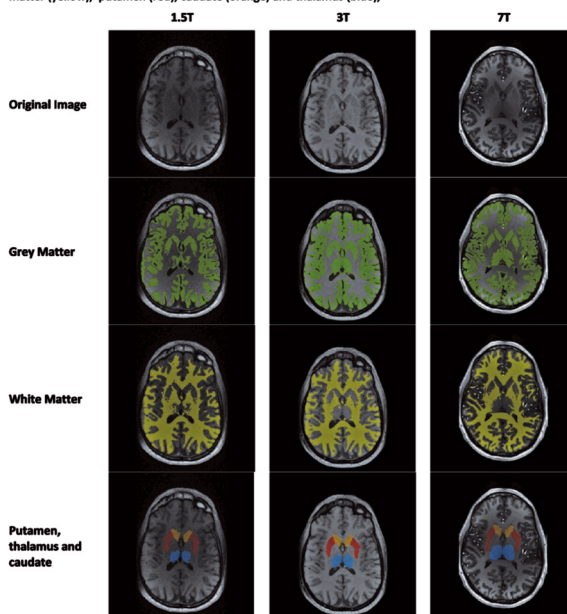

Table 1

Paired t-tests	Region						
	GM	WM	Hippocampus	Amygdala	Caudate	Putamen	Thalamus
1.5T vs. 3T	0.05	0.55	0.41	1.00	0.87	1.00	0.01
1.5T vs. 7T	0.01	0.06	1.00	0.06	0.08	0.25	0.01
3T vs. 7T	0.20	0.01	0.44	0.02	0.02	0.02	0.27

Paired t-test including seven volunteers calculated for 7 brain regions that were acquired on 3 MR scanners of various field strengths and were segmented using mbrain. High correlation was found for 1.5T and 3T for all regions except Gm and the Thalamus. 7T data, however, showed significant differences for most brain regions as compared to 1.5T and 3T.

Conclusion: To our knowledge, this is the 1st study where quantitative brain volumetry at 3 different field strengths was performed. Results showed that quantitative brain volumetry at different field strengths is possible. However, comparability cannot be guaranteed which has to be taken into account when longitudinal volumetry measurements shall be performed. This is especially true for measurements at 7T.

Disclosure: Nothing to disclose

Neuroimmunology 1

EPR1197

Use of disease-modifying therapies in paediatric relapsing remitting multiple sclerosis in the UK: A multi-centre retrospective study

O. Abdel-Mannan¹, C. Manchoon², T. Rossor³, S. Mahal¹, C. Benetou², S. Chrichton², S. Wright⁴, M. Chitre³, E. Wassmer⁵, M. Lim², C. Hemingway¹, O. Ciccarelli⁶, Y. Hacoheh⁶

¹Paediatric Neurology, Great Ormond Street Hospital, London, United Kingdom, ²Paediatric Neurology, Evelina Children's Hospital, London, United Kingdom, ³Paediatric Neurology, Addenbrooke's hospital, Cambridge, United Kingdom, ⁴Paediatric Neurology, Birmingham Children's Hospital, Birmingham, United Kingdom, ⁵Paediatric Neurology, Birmingham Children's Hospital, Birmingham, United Kingdom, ⁶Queens Square MS Centre, Institute of Neurology, London, United Kingdom

Background and aims: The approach to treatment of relapsing remitting multiple sclerosis (RRMS) in children is rapidly evolving, with 14 disease-modifying therapies (DMTs) currently licensed for adults. In this study, we aimed to describe the frequency of relapses and side effects in children on DMTs in a real-life cohort.

Methods: Children (<18yrs) with a diagnosis of RRMS, treated with DMTs, were identified from four tertiary paediatric neurology centres between 2012-2018. Annualised relapse rates (ARR) prior and on treatment were calculated.

Results: Of 82 children included, 43 (52.4%) were treated with one DMT; 34 (41.5%) with 2 DMTs, and 5 (6.1%) with three or more DMTs. The median time from initial presentation to 1st-line DMTs was 1.0 years (IQR: 0.6-2.0) and 1.8 years (IQR 1.4, 2.5) for 2nd-line DMTs. Side effects were reported in 44 (53.7%) children on 1st-line treatment and 15 (42.9%) children on 2nd-line DMTs. ARR was reduced from 2.0 to 1.2 with interferon- β / glatiramer acetate (n=66, p=0.002); 0.81 to 0.78 with dimethyl fumarate (n=8, p=0.5); 1.9 to 0.3 with fingolimod (n=11, p=0.01) and 1.8 to 0.3 with natalizumab (n=10, p<0.001).

Conclusion: There have been limited randomised trials to date for 1st-line DMTs in the paediatric population; nevertheless, newer DMTs are increasingly being used in paediatric MS. In this cohort, a reduction in ARR was observed with all DMTs. Escalating treatment to second-line DMTs resulted in a large ARR reduction.

Disclosure: Nothing to disclose

EPR1198

Differential diagnosis spectrum in paraneoplastic neurological syndromes: a population-based study.

F. Bax¹, G.L. Gigli², M.R. Valente², A. Marini¹, A. Bernardini¹, A. Vogrig³

¹Neurology Unit, University of Udine, Udine, Italy, ²Department of Medicine (DAME), Neurology Unit, Udine, Italy, ³Centre de Référence Nationale pour les Syndromes Neurologiques Paranéoplasiques, Hôpital Neurologique, Lyon, France, Lyons, France

Background and aims: To characterize the differential diagnosis spectrum and potential clinical pitfalls in the evaluation of patients with suspected paraneoplastic neurological syndromes (PNS).

Methods: A 9-year (2009-2017) population-based epidemiological study of PNS was performed in the Friuli-Venezia Giulia region (Italy). All patients undergoing search for antibodies indicative of PNS were screened. PNS diagnosis was defined by the 2004 criteria. Data on alternative diagnoses were collected and categorized according to disease etiology.

Results: Among 878 patients extensively studied for suspected PNS, 89 were diagnosed with definite PNS and 128 with possible PNS. An alternative neurological diagnosis was made in the remaining 661, as follows: neurodegenerative (93; 14.07%), autoimmune (85; 12.86%), toxic-metabolic (40; 6.05%), epilepsy/seizures (32; 4.84%), neoplastic (30; 4.54%), infectious (24; 3.63%), vasculitis (21; 3.18%), vascular diseases (23; 3.48%), psychiatric/functional (13; 1.97%), myelopathies (11; 1.67%), dizziness and vertigo (10; 1.51%), cephalalgia (5; 0.75%), peripheral nervous system diseases not better specified (129; 19.52%), cognitive dysfunction (15; 2.27%), miscellaneous neurological conditions (67; 10.29%), other non-neurological conditions (32; 4.84%) and undetermined diagnosis (13; 1.97%). Based on this differential diagnosis spectrum, a diagnostic algorithm for suspected PNS was proposed and adopted by our Center.

Conclusion: This observational, real-life study, based on clinical practice, showed that there are many different diseases that can mimic PNS, including treatable disorders that require prompt identification. This data allowed us to set up a specific diagnostic algorithm that can be used in patients with suspected PNS.

Disclosure: Nothing to disclose

EPR1199

Immune-mediated neurotoxic syndromes related to immune checkpoint inhibitors: experience in a tertiary care center.

Á. Beltrán Corbellini¹, P. Parra Díaz¹, J.L. Chico García², F. Rodríguez Jorge², P. Álvarez Ballesteros³, A. Soria Rivas³, Í. Corral Corral¹, F.J. Buisan Catevilla¹
¹Neurology, Hospital Ramón y Cajal, Madrid, Spain,
²Neurology, Hospital Universitario Ramón y Cajal, Madrid, Spain, ³Medical Oncology, Hospital Universitario Ramón y Cajal, Madrid, Spain

Background and aims: Immunotherapy with immune checkpoint inhibitors (ICI) is revolutionizing the systemic treatment of cancer. Immune-related adverse events affecting the nervous system could be fatal and remain to be properly characterized. We aim to share our experience in the management of these patients.

Methods: Retrospective study including patients on ICI manifesting immune-related neurotoxicity along a 3-year period (2016-2019) in a tertiary care center.

Results: 12 patients were included. 8 were on anti-programmed death-1 receptor (anti-PD-1) or its ligand (anti-PD-L1), only 1 on anti-cytotoxic T lymphocyte antigen-4 (anti-CTLA4) and 3 on combined therapy. Generalized myasthenia gravis (GMG) was developed in 4 patients, immune-related encephalitis (IRE) in 6, mixed polyneuropathy in 1 and polymyositis in 1. Regarding GMG patients, 3 were seropositive, 3 debuted within the 1st 21 days of immunotherapy and all were on anti-PD-1/PD-L1. Concerning IRE patients, 3 showed pleocytosis in CSF, no patient showed changes in cranial MRI and 4 were on single anti-PD-1/PD-L1 therapy. Referring to treatment, 11 patients suspended immunotherapy and received intravenous steroids. Intravenous immunoglobulins were administered in half of patients. 10 patients presented total or partial improvement and 4 eventually died (2 with GMG).

Conclusion: Our results were consistent with literature: most of neurotoxicity (IRE, GMG) involved anti-PD1/PD-L1 and appeared within the 1st 21 days of immunotherapy. Of relevance, most of patients were early diagnosed and showed good outcomes after early treatment. Lethality was particularly notable among GMG patients.

Disclosure: Nothing to disclose

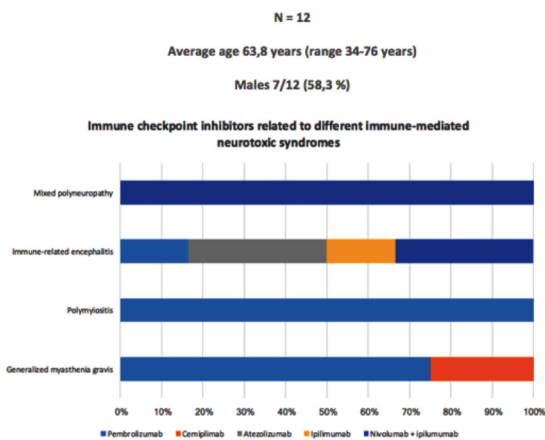

Immune checkpoint inhibitors related to different immune-mediated neurotoxic syndromes.

EPR1200

Clinical, pathological and prognostic heterogeneity in immune checkpoint inhibitors-induced myositis

S. Bocci¹, N. Volpi¹, R. Danielli², S. Bartalini¹, L. Calabrò², A.M. Di Giacomo², M. Maio², F. Giannini¹
¹Department of Medicine, Surgery and Neuroscience, University of Siena, Siena, Italy, ²Center for Immuno-Oncology, University Hospital of Siena, Siena, Italy

Background and aims: Treatment with immune checkpoint inhibitors (ICIs), including monoclonal antibodies against programmed death-1 (PD-1) and its ligand (PDL-1), is approved in many tumor types. By unbalancing immune system, ICIs may generate several multi-organ immune-related Adverse Events (irAEs), including neuromuscular manifestations.

Methods: Among 406 patients with solid tumors treated with ICIs in Siena's Center for Immuno-Oncology between 2013 and 2019, we identified 4 (<1%) metastatic melanoma patients presenting clinical, electromyographic and laboratory findings suggestive of myopathy, alone or associated to other neurological irAEs. All patients underwent muscular biopsy.

Results: Patient 1 presented ptosis, fluid dysphagia, myalgias and lower limbs weakness after first anti-PD1 administration. Muscular biopsy showed granulomatous myositis. Specific antibodies and repetitive nerve stimulation showed concomitant Myasthenia Gravis (MG). Patient recovered in 7 weeks with oral steroids. Patient 2 presented dropped head, bilateral ptosis, hypophonia, fatigue and dyspnea after 2nd anti-PD1 administration. Muscular biopsy showed necrotizing myositis with minimum inflammation. Specific antibodies showed concomitant MG. Patient required non-invasive ventilation and intravenous and oral steroids, slowly recovering within 6 months. Patients 3 and 4 showed polymyositis-like pathological pattern after anti-PD1 therapy, with markedly different courses: the 1st had mild disease, fully recovered in 3 months with oral steroid, whereas the 2nd had severe and prolonged course, requiring hospitalization, invasive ventilation and multiple immunoactive therapies.

Conclusion: ICIs-induced myositis can present with different clinical and pathological features, isolated or associated to MG. Ocular muscles are frequently involved (4/4 in our series) regardless MG co-morbidity. Severity, course and prognosis are heterogeneous and apparently unrelated to different pathological patterns.

Disclosure: Nothing to disclose

EPR1201

Epileptic seizures of suspected autoimmune etiology: a multicenter retrospective characterization.

S. Bozzetti¹, S. Ferrari¹, F. Rossini², E. Trinkka², R. Höftberger³, S. Mariotto¹
¹VERONA, Italy, ²Salzburg, Austria, ³Clinical Institute of Neurology, Vienna, Austria

Background and aims: Specific scores were recently proposed to identify antibody-positive patients (APE2) and predict immunotherapy response (RITE2) in subjects with otherwise unexplained epilepsy. Aim of our study was to compare clinical/paraclinical data with autoantibodies status in a European multicenter cohort and validate the predictive value of the proposed scores.

Methods: We retrospectively analyzed clinical/paraclinical data of 92 patients referred to the Neurology Unit of Verona and Salzburg between January-2014 and July-2019 with new onset epilepsy, status epilepticus, or chronic epilepsy of unknown etiology and with available paired serum/CSF samples. Fixed and live cell-based-assays, tissue-based assays, immunoblot, and live rat hippocampal cell culture were performed at the reference laboratories to detect anti-neuronal and anti-glia antibodies. The APE2/RITE2 scores were then calculated and compared with clinical and laboratory data.

Results: Autoantibodies were detected in 29 patients, with multiple positivity observed in 6 cases. The APE2 score correlated significantly with antibody positivity ($p=0.014$). In particular, the presence of neuropsychiatric symptoms ($p<0.01$), movement disorders ($p<0.01$), dysautonomic symptoms ($p=0.03$), faciobrachial dyskinesias ($p=0.03$), and cancer history ($p<0.01$) significantly correlated with the presence of autoantibodies. Status epilepticus was significantly more frequent in seronegative patients ($p<0.01$). Among the items of the RITE2 score, only early initiation of immunotherapy correlated with a good treatment response ($p=0.001$), whereas an oncologic anamnesis was significantly more common in the non-responders ($p<0.01$). Persistence of neuropsychiatric symptoms and seizures significantly influenced prolonged treatment choices.

Conclusion: The extensive clinical and laboratory analyses here reported provide novel cues on the possible autoimmune origin and management of epilepsy of otherwise unknown etiology.

Disclosure: Nothing to disclose

EPR1202

Hippocampal Regional Vulnerability to Damage Differs Between MS and Neuromyelitis Optica

L. Cacciaguerra¹, G.C. Riccitelli², M. Radaelli³, E. Pagani², M.A. Rocca¹, M. Filippi²

¹Neuroimaging Research Unit, Institute of Experimental Neurology, Division of Neuroscience; and Neurology Unit, IRCCS San Raffaele Scientific Institute, Milan, Italy,

²Neuroimaging Research Unit, Institute of Experimental Neurology, Division of Neuroscience, IRCCS San Raffaele Scientific Institute, Milan, Italy, ³Neurology Unit, IRCCS San Raffaele Scientific Institute, Milan, Italy

Background and aims: In multiple sclerosis (MS), hippocampal subfields have different susceptibility to damage and there is in-vivo evidence of dentate gyrus (DG) hypertrophy as a possible response to the inflammatory environment. Less is known about other inflammatory diseases like neuromyelitis optica spectrum disorders (NMOSD).

Methods: 28 seropositive NMOSD patients, 24 age- and disease duration-matched relapsing-remitting MS and 20 healthy controls (HC) underwent a 3.0T MRI. From 3D-T1-weighted sequence, manual hippocampal segmentation was performed. Brain T2 and T1 lesion volumes (LV) were also assessed. From diffusion weighted sequences, a probabilistic tractography was run to assess microstructural damage of hippocampal connections (fornix, uncinate fasciculus [UF] and cingulum).

Results: Compared to HC, NMOSD patients had similar global hippocampal volumes and mild atrophy in the Cornu Ammonis (CA) 1 subfield, whereas MS patients had significant global and regional hippocampal atrophy (especially in the CA1 and Subiculum, $p < 0.001$). DG hypertrophy was found in MS (right $p < 0.05$, left $p < 0.001$), but not in NMOSD. Hippocampal anatomical connections were damaged in MS ($p < 0.001$) and preserved in NMOSD. No correlation between regional hippocampal atrophy, brain T2 and T1 LVs and measures of hippocampal disconnection emerged in NMOSD patients. In MS, hippocampal volume abnormalities were significantly related to brain T2 and T1 LVs and to damage of the cingulum and UF ($r = -0.8$, $p = 0.01$).

Conclusion: The preferential susceptibility to damage of the CA1 is a common feature in neuroinflammatory diseases. However, DG hypertrophy is peculiar to MS, suggesting that other factors, in addition to inflammation, contribute to this process.

Disclosure: Nothing to disclose

EPR1203

MRI characterization of brain and hippocampal atrophy in Limbic Encephalitis and correlation with cognitive outcome.

S. Casagrande¹, S. Filippini¹, S. Ferrari², M. Romoli¹, E. Fainardi³, M. Paganini⁴, A. Barilaro⁴, L. Massacesi¹

¹Department of Neuroscience, Drugs and Child Health, University of Florence, Florence, Italy, ²University of Florence, Florence, Italy, ³Neuroradiology, Careggi

University Hospital-University of Florence, Florence, Italy, ⁴Department of Neurology 2, Careggi University Hospital,

Florence, Italy

Background and aims: Limbic Encephalitis (LE) is an Autoimmune Encephalitis frequently leading to severe disability, including cognitive deterioration. During the 1st stage of the disease T2-weighted Magnetic Resonance imaging (MRi) usually shows increased signal of 1 or both medial temporal lobes whereas whole-hippocampal atrophy is frequently observed in advanced stages. To date, in LE, association between brain atrophy and cognitive outcome is poorly characterized and no data exist regarding hippocampal subfields involvement.

Methods: Consecutive patients, age >18, fulfilling the 2016 LE diagnostic criteria, admitted in the Careggi University Hospital between 2013 and 2017 and followed for a median of 52 months, were retrospectively included. In these patients, whole brain and hippocampal atrophy were evaluated by MRi using dedicated softwares (FSL SIENA/SIENAX and FreeSurfer), comparing in each of them the latest follow-up scan with the 1 closest to disease onset. Neuropsychological evaluation of cognitive functions was also performed during follow up.

Results: In all the patients included ($n=6$) pathological rates of both global cerebral and hippocampal atrophy were observed. Most patients did not show relevant deterioration of memory domains whereas residual impairment of frontal functions was frequently observed. Cognitive impairment was strongly associated with global atrophy. Memory impairment was associated with residual hippocampal volume more than with hippocampal atrophy rate. In all patients, specific hippocampal subfields, as the amygdala transition area were more involved than others, regardless of auto-antibody status.

Conclusion: In LE residual cognitive deficit is the result of an extended/global structural damage more than confined in the hippocampus.

Disclosure: Nothing to disclose

EPR1204

Clinical and serological characteristics of patients with double seronegative Myasthenia Gravis

V. Damato¹, T. Smith¹, M. Woodhall¹, G. Spagni², R. Iorio², L. Jacobson¹, A.C. Vincent¹, P. Waters¹, S. Irani¹, A. Evoli²

¹Nuffield Department of Clinical Neuroscience, University of Oxford, Oxford, United Kingdom, ²IRCCS Gemelli Hospital, Rome, Italy

Background and aims: Myasthenia gravis (MG) patients without AChR or MuSK antibodies by radioimmuno-precipitation assay (RIPA) are classified as seronegative (SNMG). Live cell-based assays (CBAs) can detect AChR or MuSK antibodies in RIPA negative samples. We compared the CBA-screening of MG antibodies using single antigen transfection with a combinatorial assay, incorporating AChR and MuSK in a single test, and describe the features of a well-characterized cohort of SNMG patients.

Methods: Sera from 70 SNMG patients with electromyography signs of post-synaptic neuromuscular transmission failure were retrospectively tested by CBAs using HEK-cells transfected to express clustered-AChR (adult or foetal form), full-length MuSK or LRP4. 55/70 patients with SNMG had generalized disease, 22/70 (31%) were sampled at disease onset and 33/70 (47%) were untreated at sampling-time. 65 SNMG sera, 50 healthy-controls and 70 disease-controls were then tested on HEK-cells transfected to co-express both clustered-AChR (both adult and foetal forms) and full-length MuSK.

Results: AChR-antibodies were detected in 11/70 (16%) and MuSK-antibodies in 6/70 (8.5%). None had LRP4-antibodies or were double positive. These results were reproduced using a CBA co-expressing clustered-AChR and MuSK. For all assays, all disease and healthy-controls were negative. Both patients with clustered-AChR and MuSK antibodies had a less severe disease course than RIPA-positive MG patients. In particular, 2/6 MuSK patients presented with purely oculomotor signs.

Conclusion: Around 25% of SNMG patients had AChR or MuSK antibodies which were reliably detected with a combinatorial CBA, co-expressing AChR and MuSK. These data support the use of a combinatorial CBA for screening SNMG patient sera.

Disclosure: Nothing to disclose

EPR1205

Clinical significance of seronegative, but CSF antibody positive, anti-NMDA receptor encephalitis

M. Guasp, Y. Modena, T. Armangué, J. Dalmau, F. Graus
Neuroimmunology Program, Institut d'Investigació Biomèdica August Pi i Sunyer (IDIBAPS), Barcelona, Spain

Background and aims: To determine the frequency of anti-N-methyl-D-aspartate receptor (NMDAR) encephalitis without detectable NMDAR antibodies in serum (only positive in CSF), and to compare the clinical features of these patients with those with antibodies in serum and CSF.

Methods: Retrospective assessment of antibody serostatus and clinical features of 489 patients with anti-NMDAR encephalitis studied at Hospital Clínic, Barcelona, between January 2007 and December 2017. Serum and CSF NMDAR antibodies were determined with rat brain immunostaining, in-house cell-based assay (CBA), and a commercial CBA. Patients were considered seronegative if all 3 techniques were negative for serum antibodies.

Results: All patients had NMDAR antibodies in CSF. Serum NMDAR antibodies were not detected in 75/489 (15%) patients. Compared with the 414 seropositive patients, the seronegative were older (23.5 years [IQR: 17-43] vs. 20.5 [IQR: 14-31]; $p < 0.0001$), less frequently female (39 [52%] vs. 313 [76%]; $p < 0.001$), and had less tumors (6 [9%] vs. 128 [32%]; $p < 0.001$). In multivariate analysis, older age at diagnosis (O.R.: 1.35 [per decade]; 95% C.I.: 1.10-1.67), absence of tumor (O.R.: 0.14; 95% C.I.: 0.05-0.43), and less need for ICU admission (O.R.: 0.35; 95% C.I.: 0.18-0.69) were independent variables associated with the absence of NMDAR antibodies in serum. Time to diagnosis, treatments, relapses, and outcome were similar in seronegative and seropositive patients.

Conclusion: 15% of patients with anti-NMDAR encephalitis did not have detectable NMDAR antibodies in serum. These patients were older and had milder neurological symptoms with less frequency of tumors compared with seropositive patients.

Disclosure: Nothing to disclose

Neurological manifestations of systemic diseases

EPR1206

Autoantibodies to Annexin A2 and Cerebral Thrombosis: Insights from a Mouse Model

J. Chapman¹, E. Mindel², R. Weiss³, D. Bushi¹, O. Gera¹, D. Orion⁴, E. Shavit-Stein¹

¹Neurology, Sheba Medical Center, Ramat Gan, Israel,

²Physiology and Pharmacology, Tel Aviv University, Ramat Gan, Israel, ³Physiology and Pharmacology, Tel Aviv University, Tel Aviv, Israel, ⁴Sheba Medical Center, Tel Aviv Yaffo, Israel

Background and aims: Antiphospholipid syndrome (APS) is an autoimmune disorder, manifested by thromboembolic events, recurrent spontaneous abortions and elevated titers of circulating antiphospholipid antibodies. In addition, the presence of antiphospholipid antibodies seems to confer a 5fold higher risk for stroke or transient ischemic attack. Although the major antigen of APS is $\beta 2$ glycoprotein I, it is now well established that antiphospholipid antibodies are heterogeneous and bind to various targets. Recently, antibodies to Annexin A2 (ANXA2) have been reported in APS. This is of special interest since data indicated ANXA2 as a key player in fibrinolysis. Therefore, in the present study we assessed whether anti-ANXA2 antibodies play a pathological role in thrombosis associated disease.

Methods: Mice were induced to produce anti-ANXA2 antibodies by immunization with ANXA2 (iANXA2) and control mice were immunized with adjuvant only. A middle cerebral artery occlusion stroke model was applied to the mice. The outcome of stroke severity was assessed and compared between the 2 groups.

Results: Our results indicate that antibodies to ANXA2 lead to a more severe stroke as demonstrated by a significant larger stroke infarct volume (iANXA2 $133.9 \pm 3.3 \text{mm}^3$ and control $113.7 \pm 7.4 \text{mm}^3$; $p=0.017$) and a more severe neurological outcome (iANXA2 2.2 ± 0.2 , and control 1.5 ± 0.18 ; $p=0.03$).

Conclusion: This study supports the hypothesis that autoantibodies to ANXA2 are an independent risk factor for cerebral thrombosis. Consequently, we propose screening for anti-ANXA2 antibodies should be more widely used in patients with young onset stroke.

Disclosure: Nothing to disclose

EPR1207

Neurological involvement in Eosinophilic Granulomatosis with Polyangiitis (EGPA) – is there a difference in biological biomarkers?

I. Gomes¹, A. Girão², J.P. Gomes², J. Jesus Ribeiro¹

¹Neurology, CHUC, Coimbra, Portugal, ²Internal Medicine, CHUC, Coimbra, Portugal

Background and aims: Although nervous system involvement may occur in Eosinophilic Granulomatosis with Polyangiitis (EGPA), its clinical manifestations and pathophysiology are still poorly understood. Our goals are: 1-characterize CNS/PNS involvement; 2-analyze if there is a difference in biological markers in patients with and without neurological manifestations.

Methods: Retrospective observational study, including EGPA patients with and without neurological manifestations. Demographics, clinical data and biological markers were collected. Descriptive and inferential statistics were applied.

Results: A total of 14 cases were analyzed, 9 with (group-1) and 5 without (group-2) neurological involvement. Patients from group-1 were older at EGPA diagnosis. Neurological involvement preceded EGPA diagnosis in 5 patients, and occurred during follow-up in 4 patients after a median of 4,5 years. Main CNS manifestations were stroke (n=2), bilateral central retinal artery occlusion (n=1), labyrinthine haemorrhage (n=1) and compressive dorsal myelopathy due to extradural granulation tissue (n=1). Main PNS manifestation were axonal polyneuropathy (n=3), sensorineural hearing loss (n=3) and multiplex mononeuropathy (n=1). 2 patients had both PNS and CNS affected. There were no statistical differences concerning biological markers (eosinophil count, MPO titers) between the 2 groups. All patients were treated with immunosuppressive drugs, with 2 patients unresponsive to treatment belonging to group-1.

Conclusion: EGPA related nervous system manifestations can be very pleomorphic, highlighting 4 distinct neurological scenarios in our sample - peripheral neuropathy, VIII cranial nerve neuropathy, ischemic and hemorrhagic lesions and compressive myelopathy. In our cohort, patients with neurological manifestations did not have different eosinophilic count and MPO titer comparing with patients without neurological involvement.

Disclosure: Nothing to disclose

EPR1208

Patients With Hereditary Transthyretin Amyloidosis: Insights From A Genetic Testing Program

S. Khella¹, N. Bumma², A. Gabriel³, F. Denis³, M. Stevenson³

¹Neurology, University of Pennsylvania, Philadelphia, USA,

²Hematology, The Ohio State University, Columbus, USA,

³Akcea Therapeutics, Boston, USA

Background and aims: Hereditary transthyretin (hATTR) amyloidosis is a progressive and fatal disease that results from the deposition of misfolded transthyretin (TTR) protein and leads to multisystem dysfunction, including peripheral neuropathy, cardiomyopathy, and autonomic dysfunction. The hATTR Compass Program offers genetic testing to patients suspected of having, or with a family history of, hATTR amyloidosis in the United States, Canada, and Puerto Rico. We report real-world data from this program.

Methods: Data were analyzed from 165 patients with TTR mutations identified by the hATTR Compass Program using a single gene test or gene panel.

Results: Common mutations were p.V142I/V122I (n=130), p.V50M/V30M (n=10), and p.T80A/T60A (n=12). Average patient age was 64.8 years, and 53.9% (n=89) were male. In patients testing positive for a TTR mutation, 37.6% (n=62) had a known family history, while 53.3% (n=88) and 9.1% (n=15) of patients had no family history or did not know, respectively. The TTR mutation-positive patients were 66.7% (n=110) African American, 16.4% (n=27) white, 6.1% (n=10) other ethnicities, and 10.9% (n=18) unknown. Most patients in this cohort were referred by a cardiologist (n=110; 66.7%), while neurologists referred 8 (4.8%) patients. Patients had clinical histories of sensory, motor, and autonomic dysfunction, gastrointestinal dysfunction, heart disease, and bilateral carpal tunnel syndrome. Most patients (n=97; 58.8%) were 1st referred for genetic testing and diagnosed with hATTR amyloidosis after age 60. Notably, 10.3% (n=17) of patients were diagnosed at or before age 35.

Conclusion: Recognition of hATTR amyloidosis symptoms and subsequent genetic testing facilitates diagnosis of this debilitating, fatal disease.

Disclosure: Commercial/institutional support of research statement: This study was sponsored by Akcea Therapeutics and medical writing support was provided by Apotecom.

EPR1209

Disease Burden and Healthcare Utilization Among Patients with Acute Intermittent Porphyria Experiencing Chronic Neuropathy: Analyses from a National Healthcare Database

A. Erwin¹, S. Silver², S. Meninger³, J. Tkacz⁴, V. Noxon⁴, J. Ko³

¹Cleveland Clinic Cleveland, Cleveland, USA, ²University of Michigan Medical Center, Ann Arbor, USA, ³Alnylam Pharmaceuticals, Cambridge, USA, ⁴IBM Watson Health, Bethesda, USA

Background and aims: Acute hepatic porphyria (AHP) refers to a family of rare, metabolic diseases that includes four types, acute intermittent porphyria (AIP) being the most common. AHP is characterized by potentially life-threatening acute attacks and, for some patients, chronic debilitating symptoms.

This study aimed to identify AIP patients diagnosed in a nationally representative health care database to estimate healthcare resource utilization among various segments of the AIP patients defined by porphyria attack rates, chronic symptoms, and comorbidities.

Methods: This retrospective analysis utilized the IBM® MarketScan® Commercial Claims and Medicare Supplemental Databases. Patients with at least 1 claim for AIP (ICD-10 diagnosis code E80.21) between October 1, 2015–June 30, 2018 were selected for analyses. AIP patients were segmented by frequency of attacks, presence of chronic symptoms and the presence of comorbidities. This analysis focused on the patient segment specific to chronic neuropathy. Means were reported as per patient per year (PPPY).

Results: 56 (24.9%) patients with chronic neuropathy were identified; 80.4% female, mean (SD) age 49.9 years (14.8). Mean observation time of identified diagnosed patients was 2.0 years. Patients had a mean (SD) of 2.7 (3.4) attacks PPPY; 30.4% had ≥3 attacks/year. The majority had ≥1 hospitalization (57.1%) and emergency department (ED) visit (75.0%), with a mean (SD) of 1.0 (1.4) admissions and 7.5 (23.2) ED visits PPPY.

Conclusion: Results from this national representative healthcare claims database demonstrated AIP patients experiencing chronic neuropathy have high disease burden and healthcare utilization.

Disclosure: This research was funded by Alnylam Pharmaceuticals.

EPR1210

Sjogren's Syndrome and nervous system impairment: A multi-faceted connectivity

M. Naguez, A. Mouna, M. Mhiri, M. Frih-Ayed
Neurology, Fattouma Bourguiba hospital, Monastir, Tunisia

Background and aims: Other than the occurrence of exocrine glands, Sjogren's Syndrome (SS) can be complicated by extraglandular events such as neurological disorders that can inaugurate this autoimmune disease. We aim to study the clinical, biological, radiological characteristics of neurological manifestations of SS.

Methods: This is a retrospective study involving 28 patients hospitalized at our neurology department over a period of 9 years [2010-2019] for neurological events resulted in SS not previously diagnosed. The SS diagnosis was selected according to the criteria developed by the European Consensus Group revised in 2016.

Results: 28 patients were included. The average age at diagnosis was 46.4 years. The average time between the 1st neurological event and the diagnostic confirmation was 2.4 years [20 days, 9 years]. In 15 cases, the clinical manifestations were purely neurological. 18 patients had central signs (ischemic stroke (n=6), acute/subacute myelitis (n=6), cerebellar ataxia (n=2), and focal epileptic seizure (n=4). The hyper signals of the deep white substance (n=9), subcortical (n=11), medullary (n=7), and under cortical atrophy (n=8) were diagnosed by neuroimaging. Anti-SSA and/or anti-SSB antibodies were positive in 18 patients. Primary SS diagnosis was selected in the majority of patients (n=18) with positive SSA antibodies (p=0.002). The best prognosis factors were a young age, the mono-phasic evolution, peripheral nervous system impairment (p<0.05) and a primitive SS.

Conclusion: The clinical diversity of neurological manifestations of SS can often be like ischemic or inflammatory disease, so it needs an identification of biomarkers and therapeutic protocols for better management of that disease.

Disclosure: Nothing to disclose

EPR1211

Analysis of prevalence, prognosis and related factors for neurologic complications in infective endocarditis.

M.A. Palacios Mendoza¹, Á. Rodríguez López¹, A. Gómez Roldós¹, A. Sanchez Soblechero², P.J. Melgarejo Ojalora¹, P. Muñoz³, M. Valerio³, M. Marín Arriaza³, M. Martínez Sellés⁴, H. Rodríguez Abella⁵, G. Cuerpo⁵, B. Pinilla Llorente⁶, J. De la Torre⁷, P. Vázquez Alen¹

¹Neurology, Hospital General Universitario Gregorio Marañón, Madrid, Spain, ²HOSP. GENERAL UNIVERSITARIO GREGORIO MARAÑÓN, Madrid, Spain,

³Clinical Microbiology and Infectious Disease, Hospital General Universitario Gregorio Marañón, Madrid, Spain,

⁴Cardiology, Hospital General Universitario Gregorio Marañón, Madrid, Spain, ⁵Cardiac Surgery, Hospital General Universitario Gregorio Marañón, Madrid, Spain,

⁶Internal Medicine, Hospital General Universitario Gregorio Marañón, Madrid, Spain, ⁷Radiology, Hospital General

Universitario Gregorio Marañón, Madrid, Spain

Background and aims: Neurologic complications (NC) have been associated with poor prognosis in infective endocarditis (IE). We aimed to determine the prevalence of NC in patients with IE, identify related factors and define their prognostic impact.

Methods: An observational/retrospective study in patients diagnosed with IE between 2008 and 2017. Demographic and clinical characteristics were obtained. A descriptive/comparative analysis was performed.

Results: 496 patients diagnosed with IE were included. 318 (64.1%) were male, with a mean age of 64.76 years (SD±2.02). Staphylococcus aureus (28.6%) was the most frequent microorganism. Mitral valve (48.6%) was the most frequently affected valve. 66 subjects developed NC (13.3%). 46 (69.7%) cases of ischemic stroke, 13 (19.7%) of intracranial hemorrhage, 5 (7.6%) of brain abscesses and 3 (4.5%) of encephalopathy were identified. In 42 (63.6%) patients, the NC preceded the diagnosis of IE; in the rest, the median to the appearance of NC was 14 days (RIC:19). NC implied changes in the treatment of IE in 28 patients (42.4%), mainly cessation of anticoagulation (16.7%). NC delayed the surgical treatment in 15 (22.7%) subjects. Patients with NC had higher mortality than those without NC (42.4% vs 27.9%; p=0.016). In univariate analysis, subjects with NC showed a higher frequency of previous stroke (27.3% vs 15.6%; p=0.018), hypertension (75.8% vs 54.4%; p=0.004), valvulopathy (69.7% vs 53.7%; p=0.040) and systemic embolisms (28.8% vs 16.5%; p=0.030). In multivariate analysis, hypertension (OR=2.45; 95%-CI=1.30-4.62) and systemic embolisms (OR=2.82; 95%-CI=1.49-5.34) remained as associated factors.

Conclusion: NC are associated with higher mortality in patients with IE. Hypertension and systemic embolisms are factors related to the development of NC.

Disclosure: Nothing to disclose

EPR1212

A clinical and instrument-based investigation of large and small nerve fibre impairment impacts on patients' management in ATTR-amyloidosis and provides new insights in wild-type ATTR-amyloidosis

A. Papagianni¹, S. Ihne², D. Zeller¹, S. Störk³, C. Sommer¹

¹Department of Neurology, University Hospital Würzburg, Würzburg, Germany, ²Interdisciplinary Amyloidosis Center Northern Bavaria, University Hospital Würzburg, Würzburg, Germany, ³Comprehensive Heart Failure Center (CHFC), University and University Hospital Würzburg, Würzburg, Germany

Background and aims: Polyneuropathy in ATTR amyloidosis is frequently underdiagnosed delaying effective treatment. In these patients, applying a comprehensive diagnostic algorithm could improve the detection of large and small nerve fibre impairment.

Methods: Clinical and instrument-based algorithm, including nerve conduction studies-NCS, quantitative sensory testing-QST, sympathetic skin response-SSR, quantitative sudomotor axon reflex testing-QSART and skin punch biopsies in ATTR-amyloidosis patients of the Interdisciplinary Amyloidosis Center of Northern Bavaria.

Results: 24 patients (20 wild-type-ATTRwt, 4 hereditary-ATTRv) with a median age of 76 years for ATTRwt and 70 years for ATTRv were examined. Clinical and electrophysiological findings of large fibre polyneuropathy were found in 75% of ATTRv (sensory and motor, axonal) and in 60% of ATTRwt patients (sensory and motor, predominantly axonal). In 45% of ATTRwt patients no other cause for polyneuropathy was identified after reviewing for relevant co-morbidities. Small-fibre impairment was shown in both groups. QST was abnormal in all ATTRv patients and in 80% of ATTRwt patients, SSR at the foot was absent in 5/24 patients (2 with ATTRv). QSART-response in ATTRwt group was disturbed in a length-dependent pattern. Skin biopsies (from 14 patients) showed reduced intraepidermal nerve fibre density-IENFD in all ATTRv and 7 ATTRwt patients (in 5 generalized and in 2 distal IENFD reduction). Disease progression was determined according to our test results in 3 ATTRv patients leading to change of therapy.

Conclusion: Interestingly, there is a high percentage (45%) of polyneuropathy with small fibre and autonomic impairment in ATTRwt amyloidosis patients. Using a comprehensive neurological work-up program in ATTR amyloidosis influenced treatment in our cohort.

Disclosure: This research was supported by the 2019 ASPIRE Global TTR Amyloidosis Research Grant Awards from Pfizer, Inc.

EPR1213

Erdheim-Chester disease (ECD) case-series: expanding the clinical and neuroradiological spectrum

V. Riso, S. Rossi, A. Perna, T. Nicoletti, I. Scala, G. Silvestri

Neurology, Fondazione Policlinico Universitario A. Gemelli IRCSS, Rome, Italy, Rome, Italy

Background and aims: Erdheim-Chester disease (ECD) is a subtype of adult-onset and multi-systemic histiocytosis (non-Langerhans histiocytosis), often associated with central nervous system (CNS) involvement. In this report we describe a 4 patients case-series, affected by ECD, through a full-comprehensive clinical and instrumental characterization, to expand the clinical and neuroradiological spectrum of this rare disease.

Methods: 4 patients (mean age at 1st evaluation 62.7-years old), evaluated in our neurological center from December 2015 to November 2019, underwent multisystemic clinical and radiologic examination, plus neuropsychological, neurophysiological and histopathologic studies (tibia, femur, cerebellar biopsies). 1 patient, with the rare CNS histiocytic sarcoma variant, underwent haematopoietic stem-cell transplantation (HSCT).

Results: 4/4 patients presented with cerebellar symptoms (gait ataxia and dysarthria), 2/4 manifested pseudobulbar crying and laughing at disease onset. All brain MRI showed cerebellar and brainstem alterations (in 2/4 punctiform white matter contrast-enhancement, basal ganglia iron accumulation in 2/4, cerebellar atrophy in 1/4).

Conclusion: This report expands the clinical and radiological spectrum of ECD, describing possible atypical clinical onset of this rare disease, such as pathological crying and laughing, probably explained by the alteration in pontine-cerebellar-cortical network; besides, the case-series highlights atypical MRI patterns such as contrast-enhanced punctiform cerebral white matter alteration and outline different disease progression. Moreover, in 1 fatal case, we hypothesized the coexistence of the typical ECD inflammatory/infiltrative pattern and a pseudo-degenerative progression with cerebellar atrophy and brain iron accumulation in basal ganglia areas.

Disclosure: Nothing to disclose

EPR1214

Arterial wall stiffness measured by the cardio-ankle vascular index (CAVI) is associated with neurocognitive impairment in people living with well-controlled HIV in Thailand

Q. Kaewpoowat¹, A. Rerkasem², K. Rerkasem², K. Robertson³, R. Roth⁴, S. Ausayakhun⁵, J. Choovuthayakorn⁵, K. Supparatpinyo², N. Robbins⁴

¹Research Institute of Health Sciences, Chiang Mai, Thailand, ²Research Institute for Health Sciences, Chiang Mai, Thailand, ³University of North Carolina, Chapel Hill, USA, ⁴Dartmouth Geisel School of Medicine, Hanover, USA, ⁵Chiang Mai University, Chiang Mai, Thailand

Background and aims: HIV-associated neurocognitive disorders (HAND) remain prevalent in people living with HIV (PLWH) despite widespread use of antiretroviral therapy (ART). Endothelial dysfunction potentially contributes to HAND pathogenesis. In this cross-sectional pilot study we tested whether cardio-ankle vascular index (CAVI), a novel blood method to assess arterial stiffness, is associated with HAND.

Methods: We recruited 75 non-diabetic adult PLWH from an HIV clinic in Thailand. All subjects took ART and had viral loads <50copies/mm³. We collected information regarding demographics, HIV history, medications, and comorbidities. We calculated Thai CVD scores (RAMA-EGAT; estimating 10-year risk of cardiovascular disease/stroke) and measured CAVI using the VaSera SystemTM. Subjects completed a comprehensive neurocognitive battery. Neurocognitive impairment, accounting for age and education, was defined according to the Frascati criteria (Antinori et al.2007). We constructed logistic regression models to test if high CAVI (≥ 8) was independently associated with neurocognitive impairment.

Results: 52.0% of the sample (age 45.6 \pm 8.3 years, 30.1% male) met criteria for neurocognitive impairment. None had dementia. The population had few cardiovascular risks - see Table 1. 12 patients had high CAVI (≥ 8), signifying stiffer arteries. High CAVI was independently associated with HAND (odds ratio=7.6; p=0.04), accounting for gender, income, CD4 nadir, recent CD4, and CVD score (see table 2).

Table 1. Characteristics of the sample, n=75

Variable	mean \pm S.D. / n(%)	Variable	mean \pm S.D. / n(%)
Age	45.6 (8.3)	Income (Thai Baht per month) ⁶	
Male gender	23 (30.7)	less than 3,000	5 (6.7)
Cardio-ankle vascular index	7.1 \pm 0.93	3,000-7,999	13 (17.3)
Dyslipidemia history	34 (45.3)	8,000-14,999	30 (40.0)
Body mass index ≥ 25.0	9 (12.0)	greater than 15,000	27 (36.0)
Body mass index < 18.5	12 (16.0)	Educational attainment	
Body mass index	21.6 (3.7)	some primary school	23 (30.7)
CVD score ^a	2.2 \pm 1.6	some secondary school	24 (32.0)
Total cholesterol ^a	174.4 (35.4)	some college	9 (12.0)
Triglycerides ^a	125.4 \pm 71.2	bachelor degree or higher	19 (25.3)
High density lipoprotein (mg/dL) ^a	57.2 \pm 15.6	CD4 nadir < 50 cells/mm ³ ^d	25 (33.3)
Low density lipoprotein (mg/dL) ^a	11.4 \pm 34.9	CD4 nadir (cells/mm ³) ^e	149.5 \pm 176.2
Fasting blood sugar (mg/dL) ^b	94.3 \pm 9.1	Years since CD4 nadir	10.6 \pm 4.8
Systolic blood pressure (mmHg)	124.0 \pm 11.9	Most recent CD4 (cells/mm ³)	659.3 \pm 277.7
Diastolic blood pressure (mmHg)	79.2 \pm 9.9	Years since initial HIV diagnosis	14.7 \pm 7.2
Statin use		Years on antiretroviral therapy	11.6 \pm 5.2
yes	10 (13.3)	History of abacavir use	5 (6.7)
no	46 (61.3)	History of efavirenz use	51 (68.0)
maybe (in placebo-controlled trial)	19 (25.3)	History of protease inhibitor (PI) use	23 (30.7)
Active smoker	13 (17.3)	Didanosine or stavudine (d-drug) history	47 (62.7)
Hypertension history	7 (9.3)	Cumulative PI exposure (years)	1.7 \pm 3.4
History of AIDS defining infection	26 (34.7)	Cumulative d-drug exposure (years)	3.1 \pm 3.5

S.D.=standard deviation; CVD score = Thai 10-year risk of cardiovascular disease or stroke; ^an=71; ^bn=72; ^c1 US dollar = 30 THB; ^dn=74

Table 1

Table 2. Results from logistic regression analysis demonstrating the adjusted relationship between high cardio-ankle vascular index (CAVI) and neurocognitive impairment^a

Variable	p-value	Exp(B)/odds ratio	95% CI of Exp(B)
High CAVI (≥ 8)	0.04	7.6	1.1-50.2
Gender	0.06	3.4	1.0-12.4
CD4 nadir < 50 cells/mm ³	0.30	0.5	0.2-1.8
Recent CD4	0.33	1.0	1.0-1.0
10-year CVD score $\geq 3\%$	0.68	0.7	0.2-3.3
Income < 8,000 baht (~ \$270) per month	0.05	4.0	1.0-16.0

^aResults from logistic regression analysis ("enter" method, criteria for entry p < 0.05, removal p > 0.10); model Nagelkerke R² = 0.2, p = 0.04, 71 subjects with complete data

Table 2

Conclusion: CAVI is a promising measure of endothelial dysfunction that may be independently associated with neurocognitive impairment in relatively healthy PLWH. Larger studies are necessary to confirm these findings; extend them to other HIV-infected populations; and test whether CAVI predicts neurocognitive decline in PLWH.

Disclosure: Nothing to disclose

EPR1215

Hypertrophic pachymeningitis: new horizons in diagnosis.

P. Suárez Santos¹, A. García Rúa², A.I. Pérez Álvarez³,
S. Fernández Menéndez⁴, A. Saiz Ayala⁴,
W.J. Villafani Echazú³

¹Avilés, Spain, ²Gijón, Spain, ³Neurology, Hospital
Universitario Central de Asturias, Oviedo, Spain,

⁴Radiology, Hospital Universitario Central de Asturias,
Oviedo, Spain

Background and aims: Hypertrophic pachymeningitis (HP) is a rare entity characterized by an inflammatory thickening of the dura mater. The etiologies of HP include infections, malignancy, inflammatory or autoimmune diseases. Recently an association between different antibodies such as p-ANCA and HP has been described. Our goal is to analyze the main etiologies of HP and its clinical, analytical and radiological characteristics.

Methods: We reviewed the medical records of 9 patients with HP in the Neurology Department of the Hospital Central de Asturias.

Results: We found 9 patients with a diagnosis of HP, 5 men with a mean age of 64.8 years. The most frequent symptom was headache and 3 patients developed intracranial hypertension. The most frequent radiological pattern was diffuse cerebral pachymeningitis in 6 patients, 2 presented spinal involvement and 1 associated bilateral temporal parenchymatous edema. Regarding the etiology, 3 were granulomatous polyangeitis, 2 of them with positive MPO-type p-ANCA, 2 tuberculous infections, one associated with systemic lupus erythematosus and another 1 with rheumatoid arthritis, a post-traumatic 1 and another 1 of unknown etiology although presumably inflammatory due to its good response to corticosteroids. The HP with positive MPO-type p-ANCA were the best response to immunosuppressive treatment.

Conclusion: HP is an entity whose etiopathogenesis was unknown until recently. With the recent appearance of new antibodies involved such as p-ANCA (MPO) it is possible that many of the HP previously classified as idiopathic have an autoimmune substrate and therefore an effective treatment by immunosuppressants, especially those that have associated meningeal and parenchymal inflammation.

Disclosure: Nothing to disclose

Neuro-ophthalmology/neuro-otology

EPR1216

Visual function disorders and brain morphometric changes in development visual hallucinations in Parkinson's disease

O.A. Alenikova¹, I. Goursky¹, S. Likhachev¹, O. Davidova²

¹Department of Neurology, Republican Research and Clinical Center of Neurology and Neurosurgery, Minsk, Belarus, ²Center of Ophthalmology, 10th Municipal Clinical Hospital, Minsk, Belarus

Background and aims: Pre-geniculate visual disturbances are part of non-motor symptoms in Parkinson's disease (PD). Visual processing deficiency due to brain regulating structures dysfunctions causes visual hallucinations (VH). The question arises about relationship between visual perception condition and structural changes in the brain.

Aim: to identify the correlation between visual functions and morphometric MRI parameters in PD patients with VH.

Methods: 38 non-demented PD patients were divided into 2 groups according to the presence or absence VH. 20 age-matched controls were also examined.

All participants underwent electroretinography (ERG) and computer perimetry with using 24-2-SITA and 60-4-SITA algorithms for determination of sensitivity thresholds in the central and peripheral retina. MRI study was performed with using voxel-based morphometry.

Results: PD patients with VH had longer disease duration, without differences between groups in age and PD severity. For PDpatients characteristic was a significant decrease in rod-response (scotopic ERG) and sensitivity thresholds in the peripheral retina as compared with the control group, but more pronounced in PD patients with VH (table).

MRI morphometry determined some features in patients with VH: they have significantly reduced brain volumes in the posterior parietal cortex, optic chiasm and increase in the amygdale in comparison with PDpatients without VH.

Conclusion: Predominance the blurred VH at the peripheral border of the VF in PDpatients has a direct relationship with rod system involvement and decreased visual input from retinal peripheral regions. These changes are combined with more pronounced hypotrophy in the ventral visual pathways structures (responsible for localization external objects in the space), probably amid amygdale over-activation.

Disclosure: Nothing to disclose

Table. Comparative assessment of the parameters of the studied groups

Parameters	Control group	1st group	2nd group
	n = 20	(patients with VH) n = 18	(patients without VH) n = 20
	Me (Q1, Q3)		
Age (years)	55 (50; 62)	58 (53; 64)	56 (51; 64)
UPDRS total	--	49 (40; 63)	47 (41; 60)
Part I	--	8 (6; 9)	7 (5; 9)
PD duration	--	8 (5; 12)	6 (3; 9)*
Maximal ERG	N1 Latency, ms	23.1 (19.0; 24.3)	22.5 (18.0; 23.5)
	N1 Amplitude, µB	160.0 (134.0; 173.0)	84.6 (65.6; 114.5)
	P1 Latency, ms	44.0 (40.5; 45.8)	43.2 (40; 44.5)
	P1 Amplitude, µB	282.0 (260.0; 290.0)	168.5 (139.3; 225.8)
Rod ERG	P1 Latency, ms	63.5 (60.0; 65.0)	64.5 (61.0; 67.5)
	P1 Amplitude, µB	63.1 (57.7; 69.2)	22.5 (19.0; 34.0)
24-2-SITA threshold tests			
Total photosensitivity of the central retina, dB	1351 (1243; 1457)	1330 (1221; 1423)	1328 (1216; 1448)
60-4-SITA threshold tests			
Total photosensitivity of the peripheral retina, dB	1225 (1189; 1274)	737 (709; 887)	909 (875; 942) *Δ

* - Statistically significant difference (p < 0.05) between 1st and 2nd groups (Mann-Whitney test);

Δ - Statistically significant difference (p < 0.05) between control, 1st groups and 2nd groups (Kruskal-Wallis test)

Table. Comparative assessment of the parameters of the studied groups

EPR1217

Vergence deficits in focal cerebrovascular lesions: a prospective study in 305 inpatients

E. Anagnostou¹, P. Koutsoudaki², A. Tountopoulou³, K. Spengos¹, S. Vassilopoulou⁴

¹Athens, Greece, ²Neurology, University of Athens, Athens, Greece, ³Aiginition University Hospital, Athens, Greece,

⁴Department of Neurology, National and Kapodistrian University of Athens, Aeghinition Hospital, Athens, Greece

Background and aims: A widely distributed network of midbrain, pontine, cerebellar and cortical areas subserves the neural control of vergence. I might therefore anticipate various vergence deficits in stroke patients. Here, we investigated the localizing value of bedside vergence testing with respect to different supra- and infratentorial infarction locations.

Methods: 305 patients stroke patients and 50 age-matched controls were assessed prospectively by means of bedside tests in order to evaluate slow and fast binocular (i.e. symmetrical) as well as slow and fast monocular (i.e. asymmetrical) vergence. Stroke locations, as identified on MRI, were correlated to vergence function using multinomial logistic regression.

Results: Vergence performance declined with age in both stroke patients and healthy controls. Most infarction locations were not systematically associated with vergence parameters, apart from cases with parietal lobe lesions, which showed insufficient monocular, slow and fast, vergence. Finally, patients with severe ischemic small vessel disease (Fazekas 2 or 3) showed a slight but significant decrease in their fast binocular vergence function.

Conclusion: There is only a limited localising value of vergence insufficiency in stroke. Parietal lobe lesions are more frequently associated with deficient binocular and monocular convergence. Older subjects show poor slow binocular, as well as slow and fast monocular vergence, since age was the most robust factor to emerge from our data. Extended small vessel disease also correlated with deficient vergence function suggesting a role for subcortical wide range connections in maintaining an intact vergence circuitry.

Disclosure: Nothing to disclose

EPR1218

Acute Unilateral Vestibulopathy Does Not Impair Cognition

D. Ayar¹, N. Celebisoy²

¹Ndeurology, Ege University Medical School, Izmir, Turkey,

²Ege University Medical School, Izmir, Turkey

Background and aims: To evaluate cognition in patients with acute unilateral vestibulopathy (AUV).

Methods: 21 patients with (AUV) diagnosed both clinically and with caloric testing and cervical VEMP testing were evaluated for the cognitive functions by using Mini Mental State Examination, Oktem Verbal Memory Process, Forward and Backward Digit Span, Benton's Judgment of Line Orientation, Verbal and non-verbal Cancellation and Rey-Osterrieth Complex Figure tests. Beck depression and Anxiety inventories were also given. The results were compared with the results of 20 age and sex matched healthy controls. IBM SPSS Statistics 25.0 package program was used for the statistical analysis.

Results: Demographic and clinical features of the patients are given in Figure 1. Mean percentage of canal paresis was 62% (SD: 22.4%). In 4 patients p13/n23 potential was absent and in the remaining 17 delayed on the affected side (p<0.005).

Comparison of the results of the Verbal and non-verbal Cancellation (p=0.005), Benton's Judgment of Line Orientation (p=0.042) and Backward Digit Span (p=0.029) test of the patients with the healthy controls revealed abnormalities. A very prominent difference was present regarding Beck depression (p=0.012) and anxiety inventories (p<0.001) (Figure 2). Unlike the results of the univariate multiple regression analysis revealed that Cancellation, Benton's Judgment of Line Orientation and Backward Digit Span test results were not significantly different from the healthy controls (p>0.05) when depression and anxiety scores were taken into consideration.

	Patients	Controls
Number	21 (12M, 9 F)	20 (13M, 7F)
Age (years)	Mean: 54.3, SD: 10.3 Median: 56 (min: 35, max:)	Mean: 49.3, SD: 8.5 Median: 48 (min:, max:)
Education (years)	Mean: 12.3, SD: 4 Median: 12 (min:5, max: 16)	Mean: 13.7, SD: 3.4 Median: 16 (min 5, max: 16)
Date of the test (days)		Mean:13.4, SD: 10.2 Median: 12 (min:, max:)
Affected ear		R: 10 L: 11
p13 latency (ms)		Affected ear: Mean: 14.2, SD: 3.5 Non-affected ear: Mean: 12.3, SD: 1
n23 latency (ms)		Affected ear: Mean: 25.4, SD: 5.1 Non-affected ear: Mean: 23.4, SD: 3.1

Figure 1

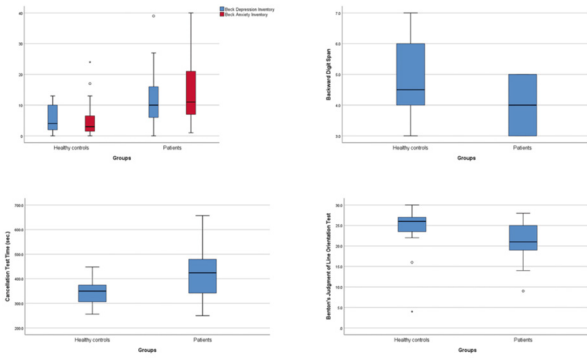

Figure 2

Conclusion: Cognitive tests mainly assessing concentration, immediate recall and spatial attention seem to be affected due to accompanying anxiety in patients with AUV.

Disclosure: Nothing to disclose

EPR1219

Modulation of slow-phase velocity and graviceptive perception in the roll plane in patients with idiopathic downbeat nystagmus

A. Fiehl¹, D. Dunkler², G. Wiest¹

¹Department of Neurology, Medical University Vienna, Vienna, Austria, ²Center for Medical Statistics, Informatics and Intelligent Systems, Medical University Vienna, Vienna, Austria

Background and aims: Downbeat-nystagmus (DBN) exhibits a well-known gravity dependent modulation in the pitch-plane. We examined DBN modulation in the roll-plane in patients with idiopathic DBN. Furthermore we assessed dynamic graviceptive perception using the Subjective Visual Vertical (SVV).

Methods: DBN was assessed in 26 patients with idiopathic DBN using videooculography at head upright position and tilted $\pm 30^\circ$ in the roll plane. SVV was assessed at the same head positions using an illuminated bar. SVV-estimates from 13 healthy subjects served as normal controls.

Results: Slow-phase velocity (SPV) of DBN in patients at 0° head position ranged from 1 to 9deg/sec, Median 2deg/sec (IQR 1, 3). SPV at 30° head tilt to the left ranged from 1 to 8deg/sec, Median 2deg/sec (1, 4) and at 30° head tilt to the right from 1 to 8deg/sec, Median 2deg/sec (1, 3), thus yielding no statistically significant differences between 0° head position and 30° head-tilts (30° left: $p=0.22$; 30° right: $p=0.14$). SVV-responses at 0° head position showed no significant difference between groups ($p=0.35$, MD 1,08). Also no significant SVV-differences were found between groups at 30° head tilts (30° left: $p=0.86$, MD 0,17; 30° right: $p=0.06$, MD 4,08).

Conclusion: We showed that DBN does not exhibit a gravity-dependent modulation in the roll-plane. Furthermore, we could demonstrate that dynamic graviceptive perception in DBN patients, using SVV estimates, does not differ significantly from normal controls. However, patients showed a higher variability in their SVV-adjustments at all head positions.

Disclosure: Nothing to disclose

EPR1220

Optic Neuropathy: a 15-year retrospective observational studyJ.M. Alves¹, M. Seabra², L. Braz², J. Guimaraes²¹Faculty of Medicine of the University of Porto, Porto, Portugal, ²Porto, Portugal

Introduction: Optic neuropathies (ON) have several aetiologies and sometimes the diagnosis established ab initio is redefined after further investigations and/or new neurological events.

We aim to identify possible predictive factors that may dictate that diagnostic change during follow-up.

Methods: We retrospectively reviewed the medical records of 156 patients with ON admitted to the ward of our Neurology Department, between January 2004 and August 2019. Clinical, laboratory and imaging data, as well as treatment protocols and follow-up were analysed.

Results: At the time of discharge from the ward, our cohort comprised 83 idiopathic ON (53.2%), 38 multiple sclerosis-related ON (24.4%), 23 ischemic ON (14.7%), 5 neuromyelitis optica spectrum disorder-related ON (3.2%), and 7 with other diagnoses (4.5%). During follow-up, 129 patients retained the ward's discharge diagnosis (82.7%) while in 27 it was redefined (17.3%). The median time between admission and change in diagnosis was 12.3 (5.4-42.9) months. Multivariate Cox regression analysis demonstrated that the patients with atypical optic neuropathy (presence of one of these clinical findings: bilateral eye involvement, visual acuity ≤ 0.1 at admission, worsening or non-substantial recovery of visual acuity during hospitalization) had lower risk of having the initial diagnosis changed (HR=0.320, 95% CI=0.138-0.743, p=0.008).

Conclusion: Our study illustrates that some patients admitted with optic neuropathy may have their diagnosis redefined during follow-up. Furthermore, it demonstrates that patients with atypical ON are those in which the diagnosis is more likely to remain during follow-up.

Disclosure: Nothing to disclose

EPR1221

Ocular flutter as a treatment-responsive symptom in Lyme disease

F. Jäger, S. Greisenegger, G. Wiest

Department of Neurology, Medical University of Vienna, Vienna, Austria

Background and aims: Ocular flutter has been reported only once before as 1st manifestation in Lyme disease (Gyllenborg and Milea, Neurology 2009). We observed gait ataxia and ocular flutter as major clinical symptoms in a 71 year old man with confirmed diagnosis of Lyme disease.

Methods: Vestibular- and ocular motor function tests were performed using video-oculography and a rotational chair system (System 2000, Micromedical Technologies, Illinois, USA). Testing was performed upon hospital admission as well as 4 weeks after symptomatic onset and after antibiotic treatment has been stopped.

Results: The diagnosis was made based on pleocytosis in CSF as well as a positive antibody index (CSF-to-serum) against *Borellia burgdorferi*. An additional MRI of the brain was negative. Ocular flutter was objectified by video-oculography. After 14 days of intravenous therapy with Ceftriaxone and subsequent oral therapy with Doxycycline, the patient's condition improved significantly. 4 weeks after the onset of the disease there was a complete remission with normalization of the pre-existing ataxic gait. In addition, a follow-up video-oculography showed normal eye movement parameters without evidence of ocular flutter.

Conclusion: We hereby report a 1st case of ocular flutter and gait ataxia as the main symptom of a confirmed Lyme disease with complete remission after antibiotic treatment.

Disclosure: Nothing to disclose

EPR1222

Effectiveness of intravenous zoledronic acid in the prevention of benign paroxysmal positional vertigo in the elderly with osteoporosisD.W. Kwack¹, D.W. Kim²¹Neurology, Konkuk University Medical Center, Seoul, Korea, Korea, Republic of, ²Neurology, Konkuk University Medical Center, Seoul, Korea, Republic of

Background and aims: Benign paroxysmal positional vertigo (BPPV) is one of the most common causes of vertigo in the elderly. Recent studies suggest that osteoporosis may be related to the occurrence of BPPV. We examine the efficacy and safety of intravenous zoledronic acid (ZOL) in elderly patients with idiopathic BPPV.

Methods: A prospective study was conducted to examine the recurrence of BPPV and adverse effects of ZOL in elderly BPPV patients. The mean T-scores were assessed by dual energy x-ray absorptiometry (DXA). Patients who met the diagnostic criteria of osteoporosis were recommended to treat with ZOL. The developments of side effects were evaluated and recurrences of BPPV were followed up 1 year later.

Results: 104 BPPV patients were enrolled and 101 of them underwent DXA. The mean lowest T-score of all patients was 2.44 ± 1.11 (range $-4.90 \sim 1.00$) and 54 patients were diagnosed with osteoporosis. The prevalence of osteoporosis was higher in women and the advanced age. 51 patients were treated with ZOL and 8 of them complained of flu-like symptoms. 1 year later, only 2 patients had recurrence of BPPV among 49 patients (4.08%). 23 patients underwent follow-up DXA at one year later, and the mean T-score was improved from -3.23 ± 0.51 to -3.05 ± 0.58 ($p=0.001$, by paired t test).

Conclusion: This result shows that the high incidence of osteoporosis in elderly patients with idiopathic BPPV. It can be suggested treatment with ZOL in old age BPPV patients with osteoporosis might prevent the recurrence of BPPV for 1 year.

Disclosure: Nothing to disclose

EPR1223

A novel CACNA1A gene mutation causing Episodic Ataxia Type 2J. Penkava¹, P. Zu Eulenburg¹, D. Huppert¹, M. Strupp², S. Becker-Bense¹¹German Center for Vertigo and Balance Disorder, Ludwig Maximilians University, Munich, Germany, ²Department of Neurology, University Munich, Munich, Germany

Background and aims: Autosomal-dominant episodic ataxias (EA) represent rare neurological disorders with recurrent atactic attacks. EA 2 is caused by a wide range of mutations of the CACNA1A gene on chromosome 19p13 encoding the alpha subunit of the P/Q-type voltage-gated calcium channel with high expression in cerebellar Purkinje cells, thereby inducing channelopathy. Here we report a novel CACNA1A mutation in a 47-year-old female patient with an EA 2 phenotype: Since the age of 17 she suffers from recurrent attacks typically triggered by emotional stress, that last for several hours and are accompanied by postural imbalance, headache, and rarely nausea. Intermittently she feels permanently dizzy and postural unstable.

Methods: Detailed patient history, clinical and orthoptic examination, video-Head-Impuls-test (v-HIT), video-oculography (VOG) and bithermal caloric testing were assessed. For genetic testing Next Generation and Sanger sequencing methods were applied.

Results: The patient showed clinically and in the VOG permanent cerebellar ocular motor dysfunction (horizontal gaze evoked and rebound nystagmus, horizontal/vertical saccadic pursuit, hypermetric horizontal saccades, optokinetic deficit) and a bilateral central VOR-deficit. Finger following showed slightly hypermetric movements. Genetic testing uncovered a novel heterozygous variant in exon 16 of the CACNA1A gene leading to a frameshift during translation and an early stop of protein biosynthesis at codon position 698. Symptomatic standard treatment with acetazolamide and 4-aminopyridine was unfortunately not effective.

Conclusion: We report on a novel variant of a CACNA1A mutation in a female patient with a typical EA 2 phenotype. The non-responding to standard therapies raises the question of genotype-phenotype correlations.

Disclosure: Nothing to disclose

EPR1224

Benign paroxysmal positional vertigo: The “Sémont PLUS maneuver” is more effective than the Sémont maneuver – a prospective multinational randomized single-blinded trial

M.L. Strupp¹, A.-S. Vinck², O. Bayer³, A. Hennig⁴, D. Obrist⁵, M. Mandala⁶

¹Department of Neurology, Universitätsklinikum Großhadern - Ludwig Maximilians Universität München, Munich, Germany, ²ENT, AZ Sint-Jan Brugge, Bruges, Belgium, ³German Center for Vertigo and Balance Disorders, University Hospital, Munich, Germany, ⁴Neurology, LMU Munich, Munich, Germany, ⁵Mechanical and Process Eng., ETH Zurich, Zurich, Switzerland, ⁶Sienna, Italy

Background and aims: To compare the efficacy of the Sémont (“SM”) with the new “Sémont PLUS maneuver” (“SM+”) in a prospective multinational randomized single-blinded trial in patients with posterior canal benign paroxysmal positional vertigo (pc-BPPV).

Methods: In a prospective multinational (Germany, Italy, Belgium) randomized single-blinded treatment trial patients with proven posterior canal BPPV – according to the diagnostic criteria of the International Classification of Vestibular Disorders – were randomly assigned (1:1) to the “SM” or “SM+”. The latter is characterized by an overextension of the head/body by 45° below earth horizontal line during step 2 of the maneuver. The 1st 3 maneuvers were performed by the physician. The patients were then instructed on how to do the maneuvers which they should perform 3times in the morning, 3times at noon and 3times at night. Each morning after the 1st maneuver of each day the patient documents in a standardized evaluation sheet, whether vertigo occurred or not. The primary endpoint was: “How long (in days) does it take until no attacks can be induced “in the morning” by the maneuvers?”

Results: In the 167 patients analysed it took 3.9 days (mean; range 1-33 days) for the “SM” and only 2.3 days (range 1-32 days) for the “SM+” for recovery ($p=0.015$, Mann-Whitney-u-test).

Conclusion: This prospective multinational randomized trial showed that the “SémontPLUS maneuver” is significantly more effective than the Sémont maneuver. It also confirms the hypothesis based on a biophysical model of BPPV.

Disclosure: M. Strupp is Joint Chief Editor of the Journal of Neurology, Editor in Chief of Frontiers of Neuro-otology and Section Editor of F1000. He has received speaker’s honoraria from Abbott, Actelion, Auris Medical, Biogen, Eisai, Grünenthal, GSK, Henning Pharma, Interacoustics, MSD, Otometrics, Pierre-Fabre, TEVA, UCB. He is a share holder of IntraBio. He acts as a consultant for Abbott, Actelion, AurisMedical, Heel, IntraBio and Sensorion.

EPR1225

Vitamin D level in vestibular disorders: no evidence for a specific deficit in benign paroxysmal positional vertigo

N. Goldschagg¹, K. Feil¹, D. Teupser², M. Strupp³
¹Munich, Germany, ²Institute of Laboratory Medicine, Ludwig Maximilians University of Munich, Munich, Germany, ³Department of Neurology, University Munich, Munich, Germany

Background and aims: To investigate whether there is a difference in vitamin D levels in patients with benign paroxysmal positional vertigo (BPPV) vs. patients with other vestibular diseases or controls with other neurological diseases but no history of dizziness or vertigo presenting in the neurological outpatient clinic of the LMU in Munich.

Methods: In a prospective study, we measured the serum levels of 25-hydroxy vitamin D in 559 patients (302 male, age 18-91 years, mean age±SD 59±16) without intake of vitamin D supplementation. 146 patients had BPPV, 193 patients other vestibular diseases (including 103 patients with peripheral vestibular disorders, such as acute unilateral vestibulopathy or Menière’s disease; 39 patients with central vestibular disorders, such as vestibular migraine or cerebellar dizziness; 51 patients with functional dizziness), and 220 controls had other neurological diseases but no history of vertigo (including 105 patients with cognitive deficits, 18 with headache, 17 with depression, 80 with other diseases).

Results: There was no statistical difference in the 25-hydroxy vitamin D levels between patients with BPPV (min. <10, max. 49ng/ml, mean±SD 24±9ng/ml) and other vestibular disorders (min. <10, max. 53ng/ml, mean±SD 25±10ng/ml). Controls in our clinic had significantly lower blood levels (min. <10, max. 52ng/ml, mean±SD 21±10ng/ml) than both vertigo groups. There was also no difference between recurrent BPPV and one-off BPPV (26±10 vs. 23±9ng/ml).

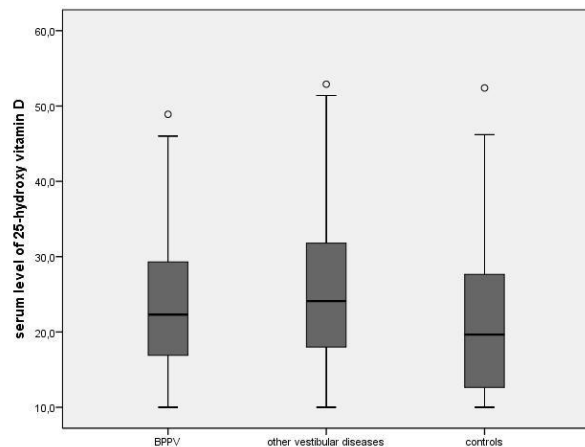

Conclusion: Our analysis does not support the idea of a specific relationship between the levels of 25-hydroxy vitamin D and BPPV or other vestibular or neurological disorders.

Disclosure: Nothing to disclose

EPR1226

Quality of life and functional impairment in acute vestibular disorders

K. Möhwald¹, H. Hadzhikolev², S. Bardins³, T. Brandt¹, E. Grill⁴, K. Jahn⁵, M. Dieterich¹, A. Zwergal¹

¹Munich, Germany, ²Neurology, Ludwig-Maximilians-Universität München, Munich, Germany, ³University of Munich (Großhadern), Munich, Germany, ⁴Institute for Medical Information Processing, Biometrics and Epidemiology (IBE) and German Center for Vertigo and Balance Disorders, University Hospital, Munich, Germany, ⁵Bad Aibling, Germany

Background and aims: Acute vestibular symptoms have a profound impact on patients' well-being. In this study, quality of life (QoL) and perceived impairment were investigated prospectively in different peripheral and central vestibular disorders during the acute symptomatic stage to decipher the most relevant underlying factors.

Methods: 175 patients with acute vestibular symptoms were categorized in the subgroups central, peripheral and episodic disorders (CV: n=47; PV: n=68; EV: n=67). QoL and symptom intensity was quantified in all patients (EQ-5D-5L, DHI). Vestibular-ocular motor signs were assessed by video-oculography, vestibular-spinal control by posturography and verticality perception by assessment of subjective visual vertical (SVV).

Results: Patients with PV had a poorer QoL and higher symptom intensity (EQ-5D-5L/DHI: $0.53 \pm 0.31/56.1 \pm 19.7$) than patients with CV ($0.66 \pm 0.28/43.3 \pm 24.0$) and EV ($0.75 \pm 0.25/46.7 \pm 21.4$). After adaptation for age, gender, cardiovascular risk factors and non-vestibular brainstem/cerebellar dysfunction PV patients persisted to have significantly poorer QoL (EQ-5D-5L: -0.17) and higher symptom intensity (DHI: +11.2) compared to CV patients. Horizontal spontaneous nystagmus (SPN) was a highly relevant factor for subgroup differences, while vertical SPN, SVV and sway path were not. EQ-5D-5L decreased with more intense horizontal SPN in CV ($R^2 = -0.57$) and PV ($R^2 = -0.5$), but not EV ($R^2 = -0.13$).

Conclusion: Patients with PV have the highest perceived impairment of all patients with acute vestibular disorders. Vestibular-ocular motor disturbance in the yaw plane has more impact than vestibular-spinal or -perceptive asymmetry in the roll and pitch plane, suggesting that horizontal visual stability is most critical for QoL.

Disclosure: Nothing to disclose

Sleep disorders 1

EPR1227

Cancelled

EPR1228

Narcolepsy type 1 associated with paraneoplastic limbic encephalitis in mediastinal seminoma

G.M. Asioli¹, S. Rossi¹, C. Franceschini², G. Sallemi¹, F. Pizza³, G. Plazzi⁴

¹University of Bologna, Bologna, Italy, ²University of Parma, Parma, Italy, ³Biomedical and Neuromotor Sciences (DIBINEM); IRCCS Istituto delle Scienze Neurologiche, Bologna, university of Bologna, Bologna, Italy, ⁴Biomedical and Neuromotor Sciences (DIBINEM); IRCCS Istituto delle Scienze Neurologiche, Bologna, university of Bologna, Bologna, Italy

Background and aims: Narcolepsy type 1 (NT1) is a chronic hypersomnia of central origin linked to the selective damage of hypothalamic hypocretin producing neurons. 2ndary NT1 has been associated with several conditions such as paraneoplastic/autoimmune encephalitis, hypothalamic damage. Here we report a case with NT1 arising in the context of a limbic encephalitis associated with mediastinal seminoma.

Methods: Clinical, neuroradiological, anatomopathological, biological and polysomnographic single patient study.

Results: A 19-year-old man developed insomnia, hyperphagia and sexual dysfunction, rapidly followed by excessive daytime sleepiness with frequent sleep attacks. Brain MRI showed T2 hyperintense lesions involving hypothalamus and optic tracts, cerebrospinal fluid (CSF) revealed a mild pleocytosis consistent with limbic encephalitis. Test for anti-neuronal antibodies were negative, and Total-body CT showed a mediastinal mass, which was diagnosed with Mediastinal Multicystic Seminoma at biopsy. After surgery and chemotherapeutic treatment, despite neuroradiological findings progressively disappeared, the patient did not display any significant clinical improvement. Clinical and polysomnographic (night- and continuous polysomnography and multiple sleep latency test - MSLT) assessment at 21 year of age disclosed hypersomnia with multiple sleep onset REM periods, CSF-hypocretin-1 was 110pg/mL, leading to a NT1 diagnosis. The patient carried the HLA DQB1*0602 allele. Sodium Oxybate treatment improved nocturnal and daytime symptoms. During follow-up the patient developed a depressive syndrome and an obsessive compulsive disorder.

Conclusion: Paraneoplastic limbic encephalitis triggered NT1 in a genetically predisposed patient. Prompt disease recognition and treatment for narcolepsy could improve patients outcome.

Disclosure: Nothing to disclose

EPR1229

Association of probable REM sleep behaviour disorder with restless legs syndrome in Parkinson's disease population.

S. Ayvazyan, S. Khachatryan, Z. Tavadyan
Department Neurology and Neurosurgery, National Institute of Health, Yerevan, Armenia

Background and aims: Sleep disorders are prevalent in Parkinson's disease (PD). REM behaviour disorder (RBD) and restless legs syndrome (RLS) being among most frequent. RBD has stronger association with PD compared to RLS. Our aim was investigating prevalence of probable RBD (pRBD) in PD patients in relation to RLS.

Methods: PD was diagnosed by UK Parkinson's Disease Society Brain Bank criteria. pRBD diagnosis was based on history of witnessed dream enactment with speaking and moving in sleep. RLS was diagnosed using International RLS Study Group's four essential criteria. Our sample was divided into 2 groups: with RLS (PDRLS) and without RLS (PDNoRLS). PD disease duration (DD) and severity data were also included. Chi-Square test was used for statistical analysis.

Results: 85 patients (F-55.3%, age mean 63.3) were enrolled, with mean DD – 5.1 years and mean H&Y stage 2.1. RLS was diagnosed in 18.8% (16) of them and pRBD was diagnosed in 28.2% (24). Age, gender distribution and disease duration were equal between groups. H&Y score was higher in PDRLS: 2.5 vs 1.98 ($p < 0.03$). The prevalence of pRBD in PDRLS group was 50% (8), while in PDNoRLS it was about half of that - 23.2% (16) ($p < 0.05$).

Conclusion: Our data show that pRBD prevalence was significantly higher in PD patients with RLS compared to patients without RLS. This finding supports recent evidence of probable RBD being a risk factor for developing of RLS in PD. Also, our finding could contribute to the longlasting dispute on RLS-PD intrinsic relationship.

Disclosure: Nothing to disclose

EPR1230

Non-motor burden in Isolated REM Sleep Behaviour disorder: systematic evaluation in a prospective cohort

L. Baldelli, L. Sambati, G. Calandra-Buonaura,
 P. Cortelli, F. Provini
Department of Biomedical and NeuroMotor Sciences (DiBiNeM), University of Bologna, Bologna, Italy

Background and aims: Consistent evidence demonstrated how isolated REM sleep behaviour disorder (iRBD) can be the prodromal stage of an overt α -synucleinopathy. The presence of cognitive and autonomic impairment increases the risk of conversion, but a comprehensive and detailed evaluation is rarely available.

Methods: We consecutively enrolled a cohort of iRBD patients and a cohort of matched controls (CTRs). Each subject underwent a battery of standardized autonomic tests (cardiovascular reflexes tests), questionnaires evaluating symptoms of dysautonomia such as the Scale for Outcomes in Parkinson's Disease-Autonomic (SCOPA-AUT), a neuropsychological evaluation and an odour identification test.

Results: The study included 32 iRBD (mean age 67.94 ± 7.03 years, 7 females) and 29 CTRs (68.03 ± 9.25 years, 5 females). The difference in years of education was not significant between the 2 groups ($p = 0.261$). At autonomic tests 18 iRBD and 1 CTR showed a pathologic Valsalva Manoeuvre ($p < 0.001$), of them 9 iRBD patients and a different CTR ($p = 0.009$) showed orthostatic hypotension (OH) at the 3rd minute of 65° tilting. Patients with OH had a longer iRBD duration: 11.74 ± 7.07 vs 6.36 ± 4.02 years; $p = 0.039$. SCOPA-AUT score was significantly increased in iRBD (11.84 ± 8.70 vs 7.50 ± 7.81 ; $p = 0.007$), especially within cardiovascular domain ($p = 0.004$). iRBD in respect to 1 CTR fulfilled the criteria for mild cognitive impairment ($p = 0.018$), with higher frequency of abnormal results in visuo-executive tasks ($p = 0.026$ and 0.049). iRBD obtained a score of 6.11 ± 2.67 at odour identification test, lower than CTRs with 8.71 ± 2.72 ($p = 0.001$).

Conclusion: iRBD shows a heavier non-motor burden, with dysautonomia usually developed over the years. The higher prevalence of dysautonomia and cognitive impairment an already present neurodegenerative process.

Disclosure: Nothing to disclose

EPR1231

Nocturnal Sleep Stability And Cerebrospinal Fluid Orexin-A Levels: Sleep And Wake Bouts

L. Barateau¹, R. Lopez², S. Chenini³, A.L. Rassu¹, S. Scholz³, M. Lotierzo⁴, J.P. Cristol⁴, I. Jaussent⁵, Y. Dauvilliers⁶

¹Montpellier, France, ²Neurology, Sleep Unit, Montpellier, France, ³Neurology, Sleep Unit, Montpellier, France, ⁴Biochemistry, Montpellier University Hospital, Montpellier, France, ⁵University of Montpellier, Montpellier, France, ⁶Hôpital Gui-de-Chauliac, Montpellier, France

Background and aims: To evaluate the relationships between cerebrospinal fluid (CSF) ORX levels and markers of nocturnal sleep stability assessed by polysomnography (PSG).

Methods: Nocturnal PSG data and CSF ORX levels of 300 drug-free subjects (29.9±15.5 yo, ORX 155±154pg/mL) with a complaint of hypersomnolence were collected in the Narcolepsy Reference Center, France. Several markers of nocturnal sleep stability were analyzed: wake (WB), sleep bouts (SB), and sleep/wake transitions (SWT). Groups were categorized according to ORX levels: two categories (≤ 110 , > 110 pg/mL, the established threshold of ORX-deficiency), and tertiles (≤ 26 , $]26; 254]$, > 254 pg/mL); and were compared using logistic regression models. Results were adjusted for age, gender and BMI.

Results: ORX-deficient subjects had more WB, SB, and SWT than the others. The WB duration was longer and the SB duration shorter in ORX-deficient category. The proportion of the shortest WB (30sec) was lower in the ORX-deficient category whereas the proportion of WB above 1min 30sec was higher. The proportion of $SB \leq 14$ min was higher among ORX-deficient patients, with opposite results for longer SB. Subsequent analyses performed in the population categorized according to tertiles of CSF ORX-A confirmed all these findings, with a strong dose-response effect of ORX levels in post-hoc comparisons. All results remained highly significant in adjusted statistical models.

Conclusion: This study provides a strong evidence of the direct effect of ORX on nocturnal sleep stabilization in humans. WB and SB are reliable markers of nighttime sleep stability, strongly correlated to CSF ORX-A levels in a dose-dependent way. These PSG biomarkers are promising to be applied in clinical and research settings.

Disclosure: Nothing to disclose

EPR1232

Type 1 narcolepsy secondary to an anti-Ma2 encephalitis

J.-B. Brunet de Courssou¹, M. Sallansonnet-Froment¹, T. Maillot², K. Michaux³, P. Depierre⁴, I. Taifas¹, J. Maillot¹, M.-L. Brechemier¹, M. Aletti⁵, C. Tafani¹, F. Bompaire¹, D. Psimaras⁶, D. Ricard¹

¹Neurology department, Hôpital d'instruction des armées Percy, Clamart, France, ²Internal medicine department, Centre Hospitalier de Mâcon, Mâcon, France, ³Pneumology department, Centre Hospitalier de Mâcon, Mâcon, France, ⁴Neurology department, Centre Hospitalier de Mâcon, Mâcon, France, ⁵Internal medicine department, Hôpital d'instruction des armées Percy, Clamart, France, ⁶Neurology department, Hôpital Pitié-Salpêtrière, Paris, France

Background and aims: Autoimmune encephalitis are rare causes of subacute cerebral dysfunction.

Methods: We report a case of narcolepsy secondary to an anti-Ma2 encephalitis.

Results: A 68-years-old man with elevated blood pressure, obesity and diabetes mellitus presented with a 1-year history of excessive daytime sleepiness with sleep attacks. Nocturnal continuous positive pressure in treatment of a proven obstructive sleep apnoea syndrome was ineffective. On the contrary, progressive cognitive decline appeared over 6 months along with walk impairment and a 4kg weight gain. Clinical examination revealed a nystagmus and static cerebellar syndrome and psychomotor slowing. EEG was normal. Protein levels in cerebrospinal fluid were of 0.86g/L. Brain MRI demonstrated hypersignals on the fluid attenuated inversion recovery sequence around the third ventricle and the cerebral aqueduct. Anti-Ma2 antibodies were found in both serum and cerebrospinal fluid. Multiple sleep latency tests were abnormal (mean sleep latency 6.2min, normal over 8min) but without sleep onset rapid eye movement periods. Hypocretin (orexin) in cerebrospinal fluid was under 50ng/mL, which allowed for type 1 narcolepsy diagnosis. Walk normalized after 3 monthly immunoglobulin perfusions, and excessive daytime sleepiness was treated effectively with pitolisant. Extensive search for cancer remains negative.

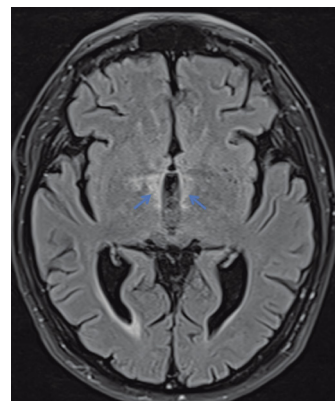

Patient's brain MRI. Fluid attenuated inversion recovery sequence with hyperintensities around the third ventricle (arrows).

Conclusion: Anti-Ma2 antibodies are present in 7% of auto-immune encephalitis or 22% of paraneoplastic encephalitis, in association with a lung or testicular cancer in up to 90% of cases. Its association with central hypersomnia, and with type I narcolepsy in rarer cases, has been described and is a consequence of auto-immune hypothalamic destruction, mirrored by a decreased in hypocretin levels in CSF.

Disclosure: Nothing to disclose

EPR1233

Slow Wave Sleep and response to Cognitive-Behavioral Therapy for Insomnia.

V. Castronovo¹, M. Sforza¹, A. Galbiati¹, E. Fasiello², F. Casoni¹, M. Zucconi¹, M. Manconi³, L. Ferini Strambi¹
¹Department of Clinical Neurosciences, Neurology - Sleep Disorders Center, IRCCS San Raffaele Scientific Institute, Milan, Italy, ²Università degli Studi di Roma "La Sapienza", Rome, Italy, ³Neurocentre of Southern Switzerland, Lugano, Switzerland

Background and aims: The 1st-choice treatment for insomnia disorder (ID) is Cognitive-Behavioral Therapy for insomnia (CBT-I). Considering that subjective evaluation of sleep is fundamental for the diagnosis and treatment of ID, CBT-I efficacy has been mostly investigated through subjective measures. Moreover, objective indices do not seem to change significantly after CBT-I. However, specific sleep features from polysomnography (PSG) could be informative and could predict treatment response. The aim of the current study is to evaluate which PSG variables could forecast CBT-I effectiveness.

Methods: 130 chronic insomnia patients (72 females, mean age 53.3±13.5) underwent 1-night of PSG pre-treatment (7-sessions group CBT-I). Insomnia Severity Index (ISI) and sleep diaries were considered the main outcomes. We used General Lineal Model (GLM) to evaluate PSG indices that may predict CBT-I response.

Results: Patients showed a significant improvement after CBT-I both at ISI (16.75±4.54 vs 9.16±4.43; p<0.001) and at sleep diaries variables (Sleep Latency: 34.7±30.8min vs 20.9±21.9, p<0.001; Wake After Sleep Onset: 69.9±66.2min vs 31.5±38.4, p<0.001; Sleep Efficiency: 75.4±17.1% vs 85.1±12.3, p<0.001). GLM revealed a significant interaction between Wake After Sleep Onset (WASO) improvement after CBT-I and the percentage of Slow Wave Sleep (SWS%) before treatment (sig. treatment*SWS% p<0.05). Moreover, we found a positive and significant correlation between Delta WASO (WASO at the baseline – WASO at the end of treatment) and SWS% (p<0.05, r=0.175).

Conclusion: These results suggest the role of SWS in predicting patients' response to CBT-I, acting as a natural mediator of "process S".

Disclosure: Nothing to disclose

EPR1234

Objective total sleep duration is not reliable in predicting effectiveness of Cognitive-Behavioral Therapy for Insomnia (CBT-I)

V. Castronovo¹, M. Sforza², A. Galbiati³, E. Fasiello⁴, C. Leitner², A. Filice², F. Casoni⁵, M. Zucconi⁶, M. Manconi⁷, L. Ferini Strambi³

¹IRCCS San Raffaele Scientific Institute, Department of Clinical Neurosciences, Neurology – Sleep Disorders Center, Milan, Italy, Milan, Italy, ²Department of Clinical Neurosciences, Neurology - Sleep Disorders Center, IRCCS San Raffaele Scientific Institute, Milan, Italy, ³Milan, Italy, ⁴Università degli Studi di Roma “La Sapienza”, Rome, Italy, ⁵Other, Milan, Italy, ⁶Dept of Clinical Neurosciences, Sleep Disorders Center, Milan, Italy, San Raffaele Scientific Institute, Milan, Italy, Milan, Italy, ⁷Neurocentre of Southern Switzerland, Lugano, Switzerland

Background and aims: There is a growing literature investigating objective Total Sleep Time (TST) as indicative of two phenotypes of Insomnia Disorder (ID): normal sleepers (with TST \geq 6hours) and short sleepers (with TST $<$ 6hours). The aim of this study is to evaluate the possibility that these 2 groups differ in terms of Cognitive-Behavioral Therapy for Insomnia (CBT-I) response, the first-choice treatment for ID.

Methods: We divided 53 ID patients (females=50.9%; mean age=56.5 \pm 11.4) into “Short Sleeper” and “Normal Sleeper” according to polysomnographic and actigraphic evaluation performed before starting 7-session group CBT-I. Insomnia Severity Index (ISI) was considered the primary outcome, whereas Sleep Efficacy (SE), Sleep Latency (SL), Wake After Sleep Onset (WASO), Number of Awakenings (N^oawk) from sleep diaries, were considered secondary outcomes.

Results: All ID patients showed significant improvements after treatment for all clinical outcomes. Both using polysomnography and actigraphy, no significant differences between “Short Sleeper” and “Normal Sleeper” were found in terms of ISI, SE, SL, WASO and N^oawk. Moreover, the accordance between actigraphy and polysomnography was poor for the identification of the 2 subgroups.

Conclusion: These findings suggest the poor reliability of objective TST in predicting CBT-I effectiveness. Moreover, only a small percentage of patients were classified as short or normal sleepers according to both polysomnography and actigraphy, pointing out the instability of the index. We conclude that these results underline the instability and poor reliability of objective TST for subtyping ID and in predicting CBT-I effectiveness.

Disclosure: Nothing to disclose

EPR1235

REM-related complex behavior and REM sleep without atonia (RSWA) after subthalamic deep brain stimulation in Parkinson's disease with REM sleep behavior disorder

F. Cavalloni¹, I. Debove¹, L. Lachenmayer¹, P. Krack¹, C. Pollo², M. Schuepbach¹, C. Bassetti¹, P. Bargiotas¹
¹Department of Neurology, University Hospital Bern (Inselspital), Berne, Switzerland, ²Neurosurgery, Bern University Hospital, Berne, Switzerland

Background and aims: Rapid eye movement (REM) sleep behavior disorder (RBD) is confirmed by polysomnographic (PSG) documentation of REM sleep without atonia (RSWA) and complex behaviors during REM sleep (CB-REM). The effect of DBS on RBD is controversial, since PSG data are usually missing.

This study aims to assess the effect of subthalamic-DBS on RSWA and CB-REM in patients with Parkinson's disease (PD) and RBD.

Methods: In this prospective case series, we analyzed polysomnographic studies and clinical data of 8 patients with PD and RBD before and 6 months after DBS. RSWA was evaluated by analysis of phasic, tonic or “any” REM-related EMG activity (EMG-REM). CB-REM was visually assessed.

Results: Post-DBS, the number of CB-REM increased significantly (12.98 \pm 15.90/h vs. 24.02 \pm 24.71/h, $p<$ 0.05). Conversely, no significant changes in phasic ($p=$ 0.782), tonic ($p=$ 0.978) or “any” ($p=$ 0.293) EMG-REM were found. The number of CB-REM correlated significantly with “any” EMG-REM (pre-DBS $r=$ 0.542, $p<$ 0.001, post-DBS $r=$ 0.460, $p<$ 0.05) and phasic EMG-REM (pre-DBS $r=$ 0.663, $p<$ 0.001, post-DBS $r=$ 0.428, $p<$ 0.05) but not with tonic EMG-REM (pre-DBS $r=$ -0.06, $p=$ 0.71, post-DBS $r=$ -0.135, $p=$ 0.495). Changes in RSWA and CB-REM were independent of changes in dopaminergic medication and PD motor scores.

Conclusion: Our results suggest that subthalamic-DBS has no direct effect on the severity and type of brainstem-related RSWA but impacts the behavioral component of RBD in PD patients. These results further highlight the notion that CB-REM and RSWA, especially tonic activity, are 2 distinct RBD elements and should be assessed separately, especially in studies that report on RBD outcome after treatment interventions.

Disclosure: Nothing to disclose

EPR1236

Exploring creative potential in narcoleptic patients

A. D'anselmo¹, M. Filardi¹, F. Pizza¹, S. Agnoli², S. Mastria³, G.E. Corazza³, G. Plazzi¹

¹Department of Biomedical and Neuromotor Sciences, Università di Bologna - Alma Mater Studiorum, Bologna, Italy, ²Marconi Institute for Creativity (MIC), Bologna, Italy, ³Department of Electrical, Electronic, and Information Engineering "Guglielmo Marconi", Università di Bologna - Alma Mater Studiorum, Bologna, Italy

Background and aims: The role of sleep on creative thinking has been supported by several studies, nevertheless only few studies investigated this relationship with respect to specific sleep stages (i.e. REM and NREM sleep). Narcolepsy type 1 (NT1) is a chronic neurological disorder characterized by hypersomnolence and untimely manifestations of REM sleep during wake and vice-versa. Cataplexy, sleep paralyzes, hypnagogic hallucinations, disrupted nocturnal sleep with overrepresentation of rapid eye movement sleep behaviour disorder and lucid dreaming complete the clinical picture. Recently, a study showed a positive correlation between REM sleep and creativity in narcoleptic patients. With this study we aimed at investigating if creativity in narcolepsy can be associated with certain symptoms and with mental dimensions (mind wandering and daydreaming) that could predict creative behaviour.

Methods: 94 NT1 patients took part in this study. Several measures of creativity have been performed: creativity achievement, explored in different life domains by a self-reported questionnaire; creative beliefs, assessed with a scale measuring the creative self; creative performance, evaluated through computerized tests assessing both convergent thinking skills (analytical and insight skills) and divergent thinking skills (generation of alternative original solutions to an open problem).

Results: Creative achievement and creative performance are both influenced by frequency of hypnagogic hallucinations and daydreaming, via a mediation effect of creative identity. Mind wandering influences creative achievement through a moderation effect of hypnagogic hallucinations.

Conclusion: Our results highlight the role of hypnagogic hallucinations in defining both the creative success and the creative performance of NT1 patients influencing their creative self-beliefs.

Disclosure: Nothing to disclose

EPR1237

Sleep duration increases after stroke: A prospective study of 438 patients

M. Dekkers¹, F. Alexiev¹, J. Jendoubi¹, N. Denier², J. Lippert¹, S. Duss¹, M. Schmidt¹, R. Wiest³, C. Bassetti¹
¹Neurology, University Hospital and University of Bern, Berne, Switzerland, ²University Hospital of Child and Adolescent Psychiatry and Psychotherapy, University Hospital and University of Bern, Berne, Switzerland, ³Support Center for Advanced Neuroimaging (SCAN), Institute for Diagnostic and Interventional Neuroradiology, Bern University Hospital, Berne, Switzerland

Background and aims: Sleep/Wake Disturbances (SWD), including long and short sleep duration, are associated with increased stroke risk. In contrast, sleep may promote neuroplasticity and recovery after stroke. We assessed changes in sleep duration after acute stroke as a 1st step to examine its potential relationship with stroke severity and outcome.

Methods: We recruited 438 patients (mean age 65 [21-86]; 64% males). 85% suffered an ischemic stroke while 15% a TIA. We used validated questionnaires to assess sleepiness, fatigue, sleep duration and quality both retrospectively before and prospectively after stroke. Recurrent events and functional outcomes at hospitalization and again at month 1, 3 and 12 post-stroke were evaluated. A randomly selected subgroup of 114 patients underwent actigraphy.

Results: We recruited 438 patients (mean age 65 [21-86]; 64% males). 85% suffered an ischemic stroke while 15% a TIA. We used validated questionnaires to assess sleepiness, fatigue, sleep duration and quality both retrospectively before and prospectively after stroke. Recurrent events and functional outcomes at hospitalization and again at month 1, 3 and 12 post-stroke were evaluated. A randomly selected subgroup of 114 patients underwent actigraphy.

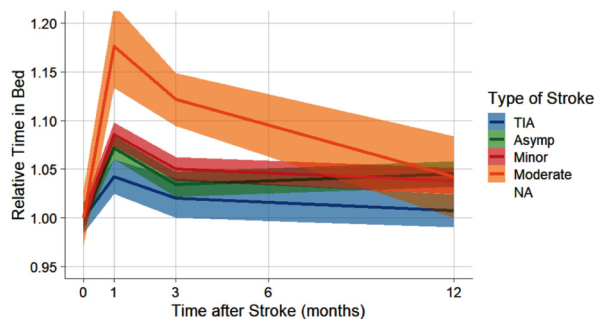

Subjective Time in Bed changes after stroke. Depicted is the change relative to prestroke Time in Bed. Asymptomatic stroke: NIHSS after treatment =0, Minor: NIHSS after treatment 1<=4, Moderate NIHSS after treatment >4.

Conclusion: These results show that transient increases in sleep duration after stroke are dependent on stroke severity. Future analyses will examine the determinants of these changes and the potential links of between increased sleep with stroke recovery and outcome.

Disclosure: This project was funded by the Swiss National Science Foundation

EPR1238

Auto-antibodies against brain antigens are not routinely detectable in serum and CSF of narcolepsy type I patients

A. Dietmann¹, M. Horn², M. Schinkelshoek³, R. Fronczek⁴, A. Salmen⁵, P. Bargiotas¹, G.J. Lammers⁶, R. Khatami⁷, C.L.S. Bassetti¹

¹Department of Neurology, Inselspital, Bern University Hospital and University of Bern, Bern, Switzerland, Berne, Switzerland, ²Center for Laboratory Medicine, , University Hospital Inselspital Bern, University of Bern, Switzerland, Berne, Switzerland, ³Neurology, Leiden University Medical Centre, Leiden, Netherlands, ⁴Leiden, Netherlands, ⁵Neuroimmunology, Inselspital, University Hospital Bern, Berne, Switzerland, ⁶Department of Neurology, Leiden University Medical Center, Leiden and Sleep-wake Centre SEIN, Heemstede, The Netherlands, Leiden, Netherlands, ⁷Barmelweid, Switzerland

Background and aims: Narcolepsy with cataplexy (NT1) is a chronic hypothalamic disorder with a presumed autoimmune etiology leading to dysfunctional hypocretin transmission. Whereas hypocretin specific T-cells have recently been identified the role of auto-antibodies remains unclear. For NT1 no specific auto-antibodies have been consistently found so far.

Methods: From a total number of 86 patients with NT1 and a control group of 22 patients suffering from hypersomnolence of presumed psychiatric origin, insufficient sleep syndrome or excessive daytime sleepiness of unknown origin paired serum/CSF samples (n=59), only serum samples (n=41) and only cerebrospinal fluid (CSF) samples (n=8) were tested for the presence of the following anti-neuronal antibodies: Biochip mosaics containing non-fixed nitrogen-frozen tissue cryosections of rat hippocampus, monkey cerebellum and cerebrum; and recombinant T-cell substrates expressing different neural antigens (MOG, AQP4, NMDAR, AMPAR1/2, DPPX, GABA1/2, LgI1, and CASPR2) as well as Immunodot assays containing paranuclear antigens (Hu, Ri, Yo, Amphiphysin, CRMP, Ma1, Ma2, SOX-1, GAD, Zic4 and TR(DNER)).

Results: We identified one NT1 patient with positive and a 2nd 1 with borderline positive Anti-Yo in serum but not CSF samples. 1 NT1 patient had positive staining for serum anti-Flotillin on cerebrum and cerebellum brain slides. 1 control had positive staining for antinuclear antibody (ANA) on hippocampal brain slides.

Conclusion: Anti-neuronal antibodies are not routinely found in serum or CSF of NT1 patients. Therefore, the detection of antineuronal antibodies in suspected NT1 patients should raise doubts about the primary diagnosis of NT1 and suggest further diagnostic evaluations.

Disclosure: Nothing to disclose

EPR1239

Neurocognitive functions and REM sleep without atonia in isolated REM sleep Behavior Disorder

A. Galbiati¹, E. Fasiello², M. Sforza¹, F. Casoni¹, M. Zucconi¹, L. Ferini Strambi¹

¹Department of Clinical Neurosciences, Neurology - Sleep Disorders Center, IRCCS San Raffaele Scientific Institute, Milan, Italy, ²Università degli Studi di Roma "La Sapienza", Rome, Italy

Background and aims: Isolated REM sleep Behavior Disorder (iRBD) is characterized by the presence of REM Sleep Without Atonia (RSWA) leading to violent behaviors. Only few studies evaluated the association between RSWA and neuropsychological functioning. The aim of this study was to assess the relationship between cognitive impairment and RSWA in iRBD patients.

Methods: 35 iRBD patients and 18 healthy controls (HC) underwent a complete polysomnography (PSG) as well as a comprehensive neuropsychological evaluation. iRBD patients were divided into 2 groups based on the presence or absence of Mild Cognitive Impairment (MCI). The PSGs were analyzed by a scorer, blind to subjects' diagnosis, to quantify the RSWA of 6 different indices of muscle activity extracted by phasic and tonic events recorded in different time series (2,3 or 30 seconds) and muscle combinations (flexor digitorum superficialis, mentalis and tibialis muscles).

Results: iRBD had increased RSWA in comparison to HC. The combination of phasic and tonic events recorded in micro epochs of 3 seconds from the mentalis muscle and flexor digitorum superficialis best differentiate iRBD and HC. RSWA indices and neuropsychological measures in the iRBD group showed a negative correlation between the scores at the Mini Mental State Examination and the phasic events index recorded by the combination of mentalis and bilateral tibialis muscles in micro epochs of 2 seconds. Finally, MCI patients exhibited increased levels of RSWA in comparison to no-MCI in all indices considered.

Conclusion: These results suggest a relationship between the loss of atonia during REM sleep and neuropsychological impairment.

Disclosure: Nothing to disclose

EPR1240

Medical Cannabis in the Treatment of Patients with Autism Spectrum Disorder

J. McVige, V. Headd, M. Alwahaidy, P. Eugeni

Dent Neurologic Institute, Buffalo, USA

Background and aims: This study evaluates the safety and efficacy of medical cannabis (MC) treatment of pain and epilepsy in patients with autism spectrum disorder (ASD). Only 13 US states currently approve MC treatment for ASD. There are limited treatment options for patients with ASD and associated challenges including self-injurious behavior (SIB), elopement, pain, epilepsy, and behavior symptoms. This study reports a case series of patients with ASD treated with MC.

Methods: Chart review of 20 patients with ASD on MC included written evaluations by patient or caregiver. Autism/Caregiver Global Impression of Change (ACGIC) measured quality of life (QOL), activity limitations, symptoms, and mood. Changes in pain, seizures, and secondary effects were assessed by 10-point Likert Scales. MC product information: dosing, route, frequency, and cost were reported.

Results: Six patients with epilepsy improved seizure frequency ($p=0.0032$) and severity ($p=0.0332$). Fourteen patients with pain improved degree of overall pain ($p<0.0001$). ACGIC scale improved in all areas: QOL, activity limitations, symptoms, and mood ($p<0.0001$). Secondary effects: patients experienced improved sleep ($p<0.0001$), mood ($p<0.0001$), aggression towards self/others ($p<0.0001$), communication abilities ($p=0.0001$), and attention/concentration ($p=0.0002$). Patients tried an average of 6.4 other medications; 50% of patients discontinued or reduced other medications while on MC. Three patients reported mild SE from MC; none discontinued due to SE.

Variable	N	Mean	SD	P-Value ¹
Quality of Life	20	8.03	1.36	<0.0001
Activity Limitations	20	6.98	1.59	<0.0001
Symptoms	20	7.75	1.66	<0.0001
Emotions	20	7.43	1.66	<0.0001
Overall Change in Pain	14	8.36	1.82	<0.0001
Seizure Frequency	6	8.08	1.43	0.0032
Seizure Duration	6	7.08	2.06	0.0560
Seizure Severity	6	7.25	1.89	0.0332
				¹ H0: Mean = 5 (No Change)

Table 1. Mean rankings from ACGIC and Pain/Epilepsy Evaluations and results from t-tests performed against null value of 5, “no change” since beginning MC treatment.

Variable	N	Mean	SD	P-Value ¹
Attention/Concentration	20	6.93	1.89	0.0002
Sleep	20	7.35	1.69	<0.0001
Mood	20	7.38	1.53	<0.0001
Nausea/Vomiting	20	5.20	0.89	0.3299
Aggression	20	7.18	1.95	<0.0001
Communication	20	6.60	1.50	0.0001
				¹ H0: Mean = 5 (No Change)

Table 2. Mean rankings from Secondary Effects Evaluations and results from t-tests performed against null value of 5, “no change” since beginning MC treatment.

Conclusion: There is a paucity of research for MC treatment for patients with ASD. Findings support previous research for MC treatment of pain and epilepsy while exploring indications for behavioral issues and QOL improvement for ASD.

Disclosure: Research has been institutionally funded by the Harry Dent Family Foundation.

Sunday, May 24 2020

Ageing and dementia 2

EPR2001

Characteristics and progression of frontotemporal lobar degeneration syndromes in a regional memory clinic network

M. Leroy¹, E. Mode², E. Skrobala³, F. Pasquier⁴, T. Lebouvier¹

¹Univ.lille, Inserm 1172, CHU Lille, DISTALZ, Lille, France,

²Saint Anne, Paris, France, ³Biostatistics Unit, EA2694, University Hospital and University of Lille, Lille, France,

⁴Inserm 1171, C HU Lille, DISTALZ, Lille, France

Background and aims: The nosology of frontotemporal lobar degeneration (FTLD) syndromes has evolved outstandingly in the past decade. Using the updated clinical criteria, our aim was to identify characteristics and progression of the FTLD syndromes diagnosed in Meotis, our regional memory clinic network, between 2010 and 2016.

Methods: The FLTD population was divided in 3 groups: behavioral variants (bvFLTD), language variants FLTD (lvFLTD) and motor variants (mFLTD), i.e. cognitive presentations of progressive supranuclear palsy and FTLD with amyotrophic lateral sclerosis. All group were compared to the Alzheimer’s disease (AD) population as well to the other neurodegenerative diseases. Disease progression was measured in the subgroup of patients that had at least 2 MMSE scores with the 1st one being >10.

Results: During the time span of the study 690 FLTD syndromes (3% of the active case load) (Figure1) and 18 831 AD were diagnosed. Most FTLD syndromes were bvFLTD (64%). Compared to AD patients, FLTD patients were younger at 1st symptoms and displayed a higher MMSE score and a longer diagnosis wandering, especially in the bvFLTD subgroup (Figure 2). Disease progression did not show any statistical difference between bvFTLD and AD patients (Figure 3).

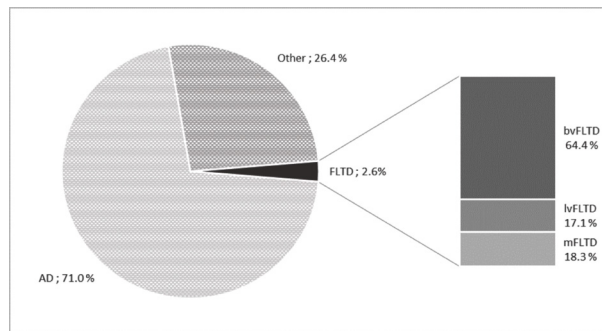

Figure 1 : Study population

Variable	bvFLTD			lvFLTD			mFLTD			AD	
	N	Mean (s)	p	N	Mean (s)	p*	N	Mean (s)	p**	N	Mean (s)
Female (%)	446	52.2	<0.0001	118	57.6	0.01	136	54	0.0003	18831	69.9
Age at first visit	446	69.4 (10.3)	<0.0001	118	72.7 (9.5)	<0.0001	136	72.0 (8.0)	<0.0001	18831	80.6 (7.5)
Age at diagnosis	446	70.2 (10.3)	<0.0001	118	73.6 (9.7)	<0.0001	136	72.8 (8.1)	<0.0001	18831	81.0 (7.3)
Delay referral (months)	359	40.0 (41.2)	<0.0001	99	30.8 (20.5)	0.63	102	35.8 (29.9)	0.03	13461	31.8 (32.0)
Diagnosis wandering (months)	446	9.9 (16.8)	<0.0001	118	10.5 (16.4)	<0.0001	136	9.1 (15.1)	<0.0001	18831	5.8 (14.2)
Follow up length (months)	446	25.2 (24.0)	<0.0001	118	24.2 (22.0)	<0.0001	136	20.2 (19.6)	0.05	18831	17.5 (21.4)
Family history (%)	446	39.9		118	23.7		136	26.2		18831	4.8
MMSE at first visit	329	22.1 (6.1)	0.02	91	20.6 (7.5)	<0.0001	88	21.9 (6.1)	<0.0001	16077	18.9 (6.6)
MMSE > 0 (%)	247	81	<0.0001	80	90	0.0054	72	75	<0.0001	12143	69.6

Figure 2 : Demography

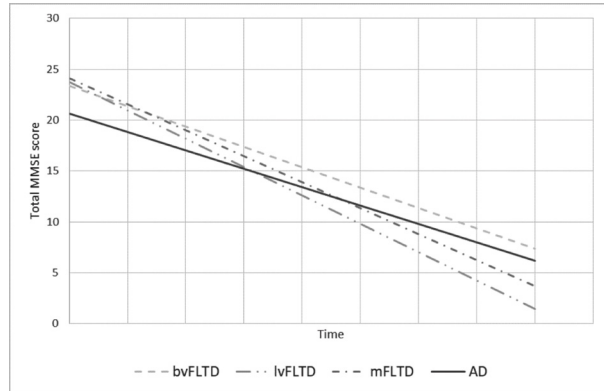

Figure 3 : Disease progression

Conclusion: To our knowledge, no other study compared patient characteristics and progression in FLTD subtypes using the new diagnostic criteria. Our results show that FTLD is still underdiagnosed, especially in the behavioural presentations. Unexpectedly, MMSE progression is not different in FLTD and AD patients.

Disclosure: Nothing to disclose

EPR2002

Investigating the clinical correlation between sCJD and presence of other neurodegenerative pathologies

J. Lumsden, D. Ritchie, A. Green, J. Mackenzie, C. Smith, R.G. Will, S. Pal

National CJD Research and Surveillance Unit, University of Edinburgh, Edinburgh, United Kingdom

Background and aims: Sporadic Creutzfeldt Jakob Disease (sCJD) is a rapidly progressive and fatal neurodegenerative disorder. Age-specific mortality rates for sCJD have increased up to 65-79 years over the past 4 decades. Of interest is an apparent reduced incidence at 80 and over. It has been hypothesised that the apparent decline in incidence of sCJD in older adults could be due to the inhibitory effects of the Alzheimer's disease (AD) associated amyloid β -protein ($A\beta$) on prion propagation.

Methods: Retrospective case note review of cases of definite sCJD over a 3 year period from 2016-2018. Cases evaluated for the presence of additional neurodegenerative pathology on neuropathological examination of brain material. Specifically $A\beta$, tau, α -synuclein and cerebral amyloid angiopathy (CAA).

Results: 123 cases of definite sCJD were identified in the UK between 2016-2018. 56/112 (50%) of cases show evidence of co-existing pathology in addition to sCJD. Cases with co-pathology had a higher age at death by 6.3 years (95% CI (2.95, 9.59) $p < 0.001$). Cases with co-pathology had a shorter disease duration by 3.7 months (95% CI (-7.04, -0.44) $p = 0.027$). Co-pathology cases were more likely to present with cognitive decline or neuropsychiatric features ($p = 0.037$). Co-pathology cases were more likely to test negative for CSF RT-QuIC and MRI. Patients with co-pathology were less likely to be assessed by the National CJD Research and Surveillance Unit in life.

Conclusion: This data suggests a potential association between the presence of other neurotoxic proteins in the brain of sCJD patients with older age of onset, shorter disease duration, and negative investigations.

Disclosure: This is independent research commissioned and funded by the Department of Health and Social Care Policy Research Programme and the Government of Scotland ("The National CJD Research and Surveillance Unit (NCJDRSU)", PR-ST-0614-00008_18). The views expressed are those of the author(s) and not necessarily those of the Department of Health and Social Care or the Government of Scotland

EPR2003

Investigating the therapeutic value of transcranial Direct Current Stimulation on language disorders in the semantic variant of Primary Progressive Aphasia

E. Mhanna¹, C. Sanches², R. Migliaccio¹, A. Kaglik², R. Levy¹, M. Teichmann¹, A. Valero Cabre²

¹Paris, France, ²Frontab, Institut du cerveau et de la moelle épinière, Paris, France

Background and aims: The semantic variant of primary progressive aphasia (sv-PPA) is the most frequent form of this neurodegenerative disease. Patients suffer great amount of language disabilities caused by atrophy of the Anterior Temporal Lobe (ATL) for which there is no effective treatment. Non-invasive brain stimulation by transcranial Direct Current (tDCS) is emerging as a therapeutic alternative in neurodegenerative conditions.

Methods: It is a double-blind sham-controlled study from 14sv-PPA patients who received daily tDCS sessions for 10 consecutive days (20 minutes, intensity: 1.57mA). Patients were randomized to 3 conditions: Left ATL-Anodal (excitatory), Right ATL-Cathodal (inhibitory) and Sham (Placebo). Participants carried out a battery of language, executive and face recognition tasks, a week prior to treatment onset, 3 days, 2 weeks and 4 months following the last session. Prior and 2 weeks following, patients underwent MRI and 18[F]-FDG-PET to assess baseline levels of ATL atrophy and hypometabolism and better understand tDCS mechanisms of action. Additionally, after each session, patients completed a questionnaire assessing comfort and tolerance. Age-matched controls were characterized for language abilities using the same tasks and underwent MRI and 18[F]-FDG-PET to obtain normative data.

Results: We did not find statistically significant improvements in semantic access. Nonetheless, the Left Anodal tDCS group showed medium effect sizes in visual semantic association visual task. Our tasks were significant in delineating patients from healthy controls. Excellent tolerance and a high level of subjective satisfaction were found for all tDCS modalities.

Conclusion: Further recruitment will be needed to conclude on the effectiveness of this modality for the treatment and its mechanism of action in sv-PPA patients

Disclosure: This project is funded by APHP (Assistance des hopitaux publics de Paris)

EPR2004

Neuregulin1 is a new CSF synaptic biomarker in Alzheimer's disease

F. Mouton Liger¹, J. Dumurgier², E. Cognat², C. Hourregue³, H. Zetterberg⁴, H. Vanderstichele⁵, E. Vanmechelen⁵, K. Blennow⁴, J. Hugon⁶, C. Paquet³
¹Center of Cognitive Neurology, Inserm 1144, Paris, Île-de-France, France métropolitaine, France, France, ²Center of Cognitive Neurology, University Paris Diderot, Paris, France, ³Center of Cognitive Neurology, University of Paris, Paris, Île-de-France, France métropolitaine, France, ⁴Section of Clinical Neuroscience and Rehabilitation, University of Gothenburg, Mölndal, Sweden, ⁵Biochemistry, ADX Neurosciences, Ghent, Belgium, ⁶Paris, France

Background and aims: Neuregulin1 (Nrg1) is a presynaptic beta-secretase 1 (BACE1)-substrate that can activate post-synaptic ErbB4 receptors. Nrg1 gene has been associated with schizophrenia. The activation of Nrg1/ErbB4 pathway can induce synaptogenesis and plasticity, can enhance the expression of NMDA and GABA receptors and is also neuroprotective. This signaling pathway can trigger neuroinflammation and can impair memory formation. Neuritic plaques are associated with Nrg1 accumulations in Alzheimer's disease (AD). Whereas studies on BACE 1 have shown increased levels in AD brains and CSF, no study has evaluated CSF Nrg1 levels in AD and MCI-AD patients.

Methods: 172 patients suffering from AD dementias (56), MCI-AD (21), non-AD MCI (32) non-AD dementias (36) and neurological controls (27) were retrospectively included in the study. After informed consent neurological exams, MRI and neuropsychological evaluations were carried out. The CSFs of all patients were evaluated with ELISA for A β 1-42, A β 1-40, tau, ptau, BACE1, and Nrg1.

Results: CSF Nrg1 concentrations were significantly enhanced in AD and MCI-AD patients as compared to non-AD MCI, non-AD dementias and neurological controls. In addition, Nrg1 levels positively correlated with tau, ptau, A β 1-40, BACE1 levels and negatively with MMSE scores and frontal battery scores.

Conclusion: A β -induced neurotoxicity leads to synaptic demise with increased CSF BACE1 and Nrg1 levels. Lack of neuroprotection may be linked to decreased Nrg1 brain levels. Nrg1 is a new biomarker that could reflect BACE1 activity and cognitive alteration in AD patients.

Disclosure: This study was supported by Fondation Chatrier and Fondation Vaincre Alzheimer

EPR2005

Does apathy predict conversion from mild cognitive impairment (MCI) to Alzheimer's disease dementia (ADD)?

N. Girtler¹, S. Pretta², E. Doglione², A. Brugnolo¹, B. Orso³, F. Massa¹, M. Pardini¹, F. Monacelli⁴, P. Calacagno⁵, R. Rissotto², C. Serrati², F. Nobili¹
¹Dept of Neuroscience (DINO GMI), University of Genoa, IRCCS Ospedale Policlinico San Martino, Genoa, Genoa, Italy, ²Neurology, IRCCS Ospedale Policlinico San Martino, Genoa, Italy, ³Dept of Neuroscience (DINO GMI), University of Genoa, Genoa, Italy, ⁴Dept of Internal Medicine (DIMI), University of Genoa, IRCCS Ospedale Policlinico San Martino, Genoa, Genoa, Italy, ⁵IRCCS Ospedale Policlinico San Martino, Genoa, Genoa, Italy

Background and aims: Apathy has been associated with increased risk of conversion from MCI to ADD but the majority of data were obtained with the limited apathy subscale of the Neuropsychiatric Inventory and few data are available using the specific Apathy Evaluation Scale (AES) (Guercio et al., JAD 2015). We administered both the subject (AES-S) and the informant (AES-I) to MCI patients who were followed up for a mean time of 1.63 \pm 0.68 years.

Methods: 110 MCI patients (63 females, age:76.6 \pm 5.5; MMSE score:26.6 \pm 1.9) underwent neuroimaging, clinical-neuropsychological evaluation and the AES-S, while the informant was administered the AES-I. 40 patients converted (MCI-C) to ADD after 0.33-3.25 years (mean:1.76 \pm 0.76) while 53 were still MCI (MCI-NC) after 0.58-2.66 years (mean: 1.65 \pm 0.59) and 17 dropped out after 0.16-2 years (mean: 1.0 \pm 0.44). The AES scores were compared between MCI-C and MCI-NC and correlated with timing of conversion.

Results: AES-S global score did not differ between subgroups. AES-I global score was significantly (p<0.03) higher in MCI-C. At post-hoc analysis, both the AES-I 'cognitive' (p<0.016) and 'emotional' (p<0.046) sub-scores were significantly higher in MCI-C. No AES-I score was correlated with timing of conversion.

Conclusion: Informant's, but not patient's, perception of cognitive and emotional apathy is of value in predicting conversion to ADD in MCI patients. As these apathy scores did not correlate with timing of conversion, apathy might be an expression of a trait of the disease in a part of MCI patients rather than a symptom denoting a more severe impairment on the way of dementia.

Disclosure: Nothing to disclose

EPR2006

RT-QuIC detection of alpha-synuclein seeds in olfactory mucosa brushings of patients with Dementia with Lewy bodies

G. Novi¹, D. Perra², A.L.C. Carobbio³, G. Schenone⁴, F.R.M. Canevari³, M. Pardini¹, D. Arnaldi¹, S.D. Morbelli⁵, P. Cocchiara², L. Brozzetti², S. Capaldi², M. Bongianini², G. Zanusso², F. Nobili¹

¹Department of Neuroscience, Rehabilitation, Ophthalmology, Genetics, Maternal and Child Health (DINOEMI), University of Genova, Genoa, Italy,

²Department of Neurosciences, Biomedicine and Movement Sciences, University of Verona, Verona, Italy, ³Department of Surgical Sciences and Integrated Diagnostics (DISC), University of Genova, Genoa, Italy, ⁴IRCCS Ospedale Policlinico San Martino, Genoa, Italy, ⁵Department of Health Sciences (DISSAL), University of Genova, Genoa, Italy

Background and aims: According to the revised 2017 McKeith's et al. criteria, diagnosis of probable/possible Dementia with Lewy bodies (DLB) is based on core clinical features and indicative biomarkers. To date, there is active research to find out and validate an accurate, possibly non-invasive diagnostic procedure to reach an in vivo diagnosis by demonstrating disease-associated alpha-synuclein (a-syn) aggregates in peripheral tissues of patients with a clinical diagnosis of DLB. In this setting, real-time quaking induced conversion (RT-QuIC) has been proven to be a feasible and highly accurate technique, able to detect trace amount of a-syn aggregates in biological samples of patients with different a-synucleinopathies.

Methods: We consecutively enrolled 12 patients (mean age: 77.5±6.1) with probable DLB. Clinical diagnosis was based on clinical core and on at least one indicative biomarker (dopamine transporter SPECT, I-123 MIBG cardiac scintigraphy or polysomnography-proven REM sleep without atonia). Our database of healthy controls included 40 subjects (mean age: 65±10). Patients underwent olfactory mucosa (OM) brushing under video transnasal video-endoscopy.

Results: OM brushing was successfully performed without adverse events. 10 out of 12 patients tested positive for a-syn amplification on RT-QuIC analysis (sensitivity: 83%), whereas 3 out of 40 healthy controls tested resulted positive (specificity: 92%).

Conclusion: We demonstrated in a small group of DLB patients that OM is a-syn RT-QuIC positive with a promising diagnostic accuracy, providing evidence of the disease associated a-syn aggregates. If confirmed in larger and independent patient series a-syn RT-QuIC-could be the appropriate test for confirming DLB diagnosis in patients with possible/probable DLB.

Disclosure: Nothing to disclose

EPR2007

Cognitive, linguistic and neuroanatomical features of primary progressive aphasia due to frontotemporal dementia gene mutations

D. Saracino¹, S. Ferrieux², M. Noguès-Lassiaille², M. Houot³, A. Funkiewiez², L. Sellami¹, V. Deramecourt⁴, F. Pasquier⁴, J. Pariente⁵, A. Géraudie⁵, D. Wallon⁶, D. Hannequin⁶, O. Martinaud⁷, S. Epelbaum¹, F. Clot⁸, A. Camuzat¹, S. Bottani⁹, D. Rinaldi¹, R. Levy², B. Dubois¹⁰, O. Colliot⁹, M. Teichmann², R. Migliaccio², I. Le Ber¹

¹Institut du Cerveau et de la Moelle Epinière, AP-HP - Hôpital Pitié-Salpêtrière, Paris, France, ²Reference Centre for Rare or Early Dementias, IM2A, Département de Neurologie, AP-HP - Hôpital Pitié-Salpêtrière, Paris, France, ³Centre of Excellence of Neurodegenerative Disease (CoEN), ICM, CIC Neurosciences, Département de Neurologie, AP-HP - Hôpital Pitié-Salpêtrière, Paris, France, ⁴Inserm U1171, DistAlz, LiCEND, CNR-MAJ, CHU Lille, Lille, France, ⁵Department of Neurology, Toulouse University Hospital, Toulouse, France, ⁶Department of Neurology, Rouen University Hospital, Rouen, France, ⁷Neuropsychologie et Imagerie de la Mémoire Humaine, CHU Caen, Caen, France, ⁸Département de Génétique, Hôpital de la Pitié-Salpêtrière - APHP, Paris, France, ⁹Aramis Project Team, Inria Research Center, Institut du Cerveau et de la Moelle épinière (ICM), AP-HP - Hôpital Pitié-Salpêtrière, Paris, France, ¹⁰Department of Cognitive Neurology and Alzheimer's Disease, Groupe Hospitalier de la Pitié Salpêtrière, Paris, France

Background and aims: Primary progressive aphasia (PPAs) caused by mutations in frontotemporal dementia (FTD) genes are rare. Few such patients have been reported thus far, but the specific linguistic features of genetic PPA have not been extensively characterized in large cohorts. Studying genetic PPA allows to characterize homogeneous groups of patients with predictable underlying pathology, and potentially link specific molecular dysfunctions with clinical phenotypes. We aimed at characterizing demographic, linguistic and neuroanatomical profiles specific to genetic forms of PPA.

Methods: We prospectively enrolled 1,696 FTD and PPA patients in a clinico-genetic study through a national network since 1996. 43 PPA patients carrying FTD mutations with complete clinical, neuropsychological and linguistic dataset were included. We analysed cortical thickness as a measure of brain atrophy with FreeSurfer 6.0.

Results: Amongst the 43 genetic PPA patients, 14 had logopenic (lvPPA), 11 non-fluent/agrammatic (nfvPPA), 10 mixed, and 8 semantic (svPPA) variants (Figure 1). GRN mutations were, by far, the most frequent cause of genetic PPA (32/43, 75%), before C9orf72 (16%) and other genes (9%). The commonest phenotype in GRN carriers (13/32) was lvPPA, which correlated with a peak of atrophy in left posterior temporal cortex and temporo-parietal junction (Figure 2). Conversely, the semantic variant was mainly caused by C9orf72 and other genes.

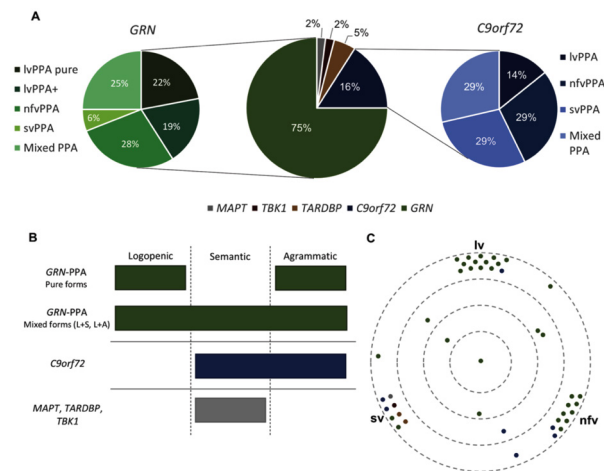

Figure 1. Overall description of the genetic PPA cohort. A: causative genes and proportion of clinical variants in the 2 main genetic forms. B: schematic representation of the contribution of each gene to the clinical phenotypes. C: distribution of the patients with respect to the linguistic deficits; the colour corresponds to the causative gene.

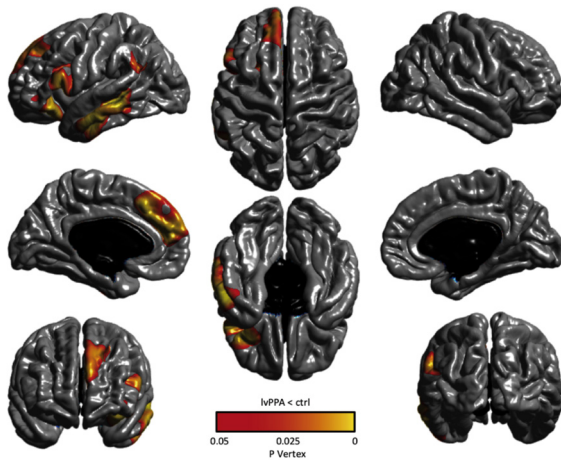

Figure 2. Cortical thickness analysis of 8 lvPPA-GRN patients compared to 20 controls. The voxelwise analysis was performed in FreeSurfer 6.0 and SurfStat, using vertex-wise correction with a threshold of $p < 0.05$. Patients displayed atrophy in left posterior middle temporal gyrus, temporo-parietal junction, prefrontal and orbitofrontal cortex.

Conclusion: This study, the first in-depth characterization of a large cohort of genetic PPA patients, highlights GRN mutations as a relevant cause of amyloid-negative lvPPA. Overall, different neurodegenerative trajectories distinguish PPAs due to GRN mutations from those associated with other less common causes.

Disclosure: Nothing to disclose

EPR2008

Normal pressure hydrocephalus as a neurodegenerative disorder – evidence from a monocentric study

K. Müller-Schmitz¹, T. Lipka¹, F. Schmitz², R.J. Seitz¹
¹Neurology, LVR-Klinikum Düsseldorf, Düsseldorf, Germany,
²Computer Science, University Hospital Düsseldorf, Düsseldorf, Germany

Background and aims: The hallmark of normal pressure hydrocephalus (NPH) is the reversal of cognitive decline, gait disturbance and urine incontinence upon drainage of 50ml cerebrospinal fluid (CSF). As NPH has recently been questioned to represent a neurological entity, we aimed at assessing if clinical and laboratory variables may differentiate an idiopathic NPH from a neurodegenerative NPH.

Methods: Data of 66 consecutive patients with NPH (2016–2018) were analyzed with regard to cognitive and walking functions before and after CSF drainage. In CSF S100, NSE, amyloid β -protein, tau-protein, phospho-tau were measured. Statistical analysis was carried out with ANOVA and a multiple linear regression. An artificial neural network trained with the main clinical predictors was applied to verify the results and to classify another 37 consecutive patients (2019).

Results: Only those patients with a CSF constellation typical for Alzheimer's disease (N=28) improved significantly in specific cognitive and walking functions after CSF drainage. These "Alzheimer positive" patients (78 ± 6 years) were older ($p < 0.01$) than the "Alzheimer negative" patients (74 ± 6 years). The "Alzheimer positive" constellation in CSF predicted the improvement in the timed up and go test ($p = 0.014$) and the clock drawing test ($p = 0.045$) after CSF drainage. The artificial neural network analysis proved to succeed in patient classification.

Conclusion: Our data suggest a high coincidence of Alzheimer's disease in NPH patients. By contrast, NPH occurs seldom in patients with Alzheimer's disease. Moreover, our results substantiate the recently suggested dichotomy of a neurodegenerative NPH which is common and an idiopathic NPH which is rare.

Disclosure: Nothing to disclose

EPR2009

Significant discrepancies in amyloid status A+/A- in CSF based on A β 1-42 measurement or A β 1-42 /A β 1-40 ratio.

C. Tisserand¹, D. Gouilly², M. Benaiteau³, M. Rafiq¹, L. Nogueira⁴, J. Pariente³

¹Cognitive Neurology, Epilepsy and Movement Disorders, CHU Toulouse, Toulouse, France, ²Toulouse, France, ³CHU Toulouse, Neurology, Toulouse, France, ⁴Cell Biology and Cytology, CHU Toulouse, Toulouse, France

Background and aims: Amyloid is a biomarker of Alzheimer's disease which can be assessed by quantification of A β 1-42 rates in the CSF after lumbar puncture. Although, the A β 1-42/A β 1-40 ratio is suggested to be more specific than A β 1-42 alone to distinguish subjects with Alzheimer's disease (Hansson et al., 2019), the discrepancies between both amyloid measurements have not been investigated yet.

Methods: We analysed the adjustment of amyloid status (A- or A+) after A β 1-42/A β 1-40 ratio calculation. CSF of 738 subjects admitted in our neurological department between January 2017 and June 2019 were analysed. A β 1-42/A β 1-40 ratio was calculated only in case of intermediate or ambiguous profile (n=176) in 2017-2018 and it was systematically performed (n= 110) in 2019. The biomarkers concentrations were measured by ELISA (INNOTEST, Fujirebio). We assessed the modification of the amyloid status in whole population and during these two periods of investigation by McNemar test.

Results: Mean age of our population was 69. 67% of A+ subjects after A β 1-42 measurement became A- after A β 1-42/A β 1-40 ratio calculation (p<0.0001) and 18% of A- subjects became A+ (p<0.0001). These proportions were similar as in 2017-2018 group (68% and 29% respectively, p<0.0001), and in 2019 group (70% and 8% respectively, p<0.0001).

Conclusion: Amyloid status estimation is different between A β 1-42 and A β 1-42/A β 1-40 ratio. Our results strengthen the proposition to systematically use the A β 1-42/A β 1-40 ratio as an amyloid biomarker in the diagnostic of Alzheimer's disease. Nonetheless these conclusions must be replicated in an older cohort of patient.

Disclosure: Nothing to disclose

EPR2010

Neuroimaging characteristics of stable mild cognitive impairment, prodromal Alzheimer's disease and prodromal dementia with Lewy bodies

T.G. Siddiqui¹, T. Whitfield¹, S.J. Praharaju², D. Sadiq¹, H. Kazmi¹, A. Ben-Joseph³, Z. Walker¹

¹Division of Psychiatry, University College London, London, United Kingdom, ²Radiology, Princess Alexandra Hospital NHS Trust, Harlow, United Kingdom, ³Preventive Neurology Unit, Queen Mary University of London, London, United Kingdom

Background and aims: Mild cognitive impairment is a heterogeneous condition that is a risk factor for developing dementia. Many studies have focused on prodromal Alzheimer's disease (Prod-AD). However, few have addressed prodromal dementia with Lewy bodies (Prod-DLB). The aim of this study was to compare MRI visual measures in stable mild cognitive impairment patients (Stable-MCI), Prod-AD and Prod-DLB.

Methods: Of 1814 patients assessed in the Essex memory clinic, 424 had MCI at baseline and had yearly follow-up data available. All patients underwent comprehensive clinical and cognitive assessment at each clinic visit. MRI scans were acquired at baseline, corresponding to the time of initial MCI diagnosis. At follow-up, patients were identified as stable MCI, AD or DLB; and retrospectively their baseline diagnoses were classified as Stable-MCI, Prod-AD and Prod-DLB. 2 raters blind to follow-up diagnosis rated all MRI scans for medial temporal atrophy (MTA), global cortical atrophy (GCA) and white matter lesions (WML, Fazekas score).

Results: MRI scans were available for 28 Prod-DLB patients and were matched against 27 Prod-AD and 28 Stable-MCI patients for age, sex and education. MTA scores were significantly greater in Prod-AD compared to Prod-DLB patients and Stable-MCI. There was no difference on GCA or WML between Prod-AD, Prod-DLB and Stable-MCI.

Conclusion: This study indicates that a simple visual rating of MTA already differs at a group level between Prod-AD and Prod-DLB. This could aid clinicians to differentiate between MCI patients who are likely to be developing AD, versus those who might progress to DLB or remain stable.

Disclosure: ZW received honoraria and grant support from GE Healthcare, HK received grant support from GE Healthcare neither related to present study

Autonomic nervous system disorders 2

EPR2011

Seropositive autoimmune autonomic ganglionopathy: clinical phenotype and autonomic biomarkers to monitor treatment response

J.S. Koay¹, E. Vichayanrat², F. Bremner¹, J. Panicker¹, B. Lang³, M. Nolano⁴, M.P. Lunn⁵, L. Watson², G. Ingle², E.M. Hagen², A. Vincent³, C. Mathias⁶, V. Iodice¹

¹Brain, Repair and Rehabilitation, University College London Queen Square Institute of Neurology, London, United Kingdom, ²Autonomic Unit, National Hospital for Neurology and Neurosurgery, London, United Kingdom, ³NDCN, University of Oxford, Oxford, United Kingdom, ⁴IRCCS, Maugeri Scientific Clinical Institutes, Scientific Institute for Research and Health Care, Telese Terme (BN), Italy, ⁵Neuroimmunology Unit, University College London Queen Square Institute of Neurology, London, United Kingdom, ⁶Autonomic & Neurovascular Medicine Centre, Hospital of St John and St Elizabeth, London, United Kingdom

Background and aims: Autoimmune autonomic ganglionopathy (AAG) is a treatable disease characterised by subacute pandysautonomia. 50% have detectable antibodies towards the ganglionic acetylcholine receptor (gAChR-Ab).

Aim: to investigate seropositive AAG patients with a comprehensive autonomic testing protocol before and after treatment to characterise the full phenotype and identify objective autonomic biomarkers to monitor immunotherapy response.

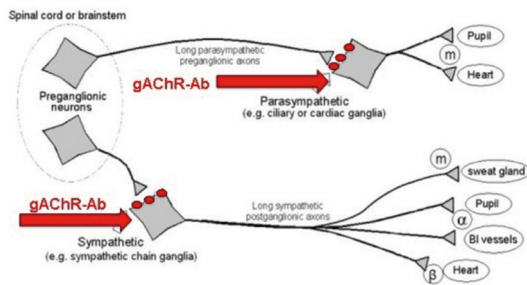

Figure 1: 50% of patients with autoimmune autonomic ganglionopathy (AAG) have a detectable antibody towards the ganglionic acetylcholine receptor (gAChR-Ab).

Methods: From 2005-2019, 15 patients were studied with autonomic failure and elevated gAChR-Ab > 100pM. 2 were excluded due to concomitant diseases. Patients underwent cardiovascular autonomic testing (head up tilt, deep breathing, Valsava manoeuvre), pupillometry, bladder, sudomotor, lacrimal and salivary testing, with autonomic symptom (COMPASS-31) and quality of life (SF-36) questionnaires, before and after immunotherapy.

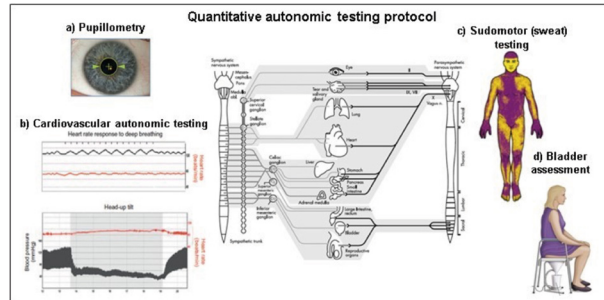

Figure 2: The comprehensive autonomic testing protocol included a) pupillometry b) cardiovascular autonomic testing c) sudomotor (sweat) testing, and d) bladder assessment.

Results: All 13/13 (100%) had sympathetic and parasympathetic cardiovascular and pupillary deficits, 9/11 (82%) had urinary retention, 7/8 (88%) had post-ganglionic sudomotor dysfunction and 6/8 (75%) had reduced saliva. 11/13 received immunotherapy. After treatment, there were significant improvements in orthostatic intolerance ratio (OIR, change in systolic blood pressure divided by time tolerated on head up tilt) (33.3[17.8-61.3] to 5.2[1.4-8.2], $P=0.007$), heart rate variability with deep breathing (1.5[0.0-3.3] to 4.5[3.0-6.3], $P=0.02$) pupillary light reaction (12.0%[5.5-18.0] to 19.0%[10.6-23.8], $P=0.02$), saliva production (0.01g/min[0.01-0.05] to 0.08g/min[0.02-0.20], $P=0.03$) and COMPASS-31 total score (52[34-64] to 17(8-31), $P=0.03$). OIR correlated with COMPASS-31 orthostatic intolerance ($P=0.03$, $\rho=0.792$) and SF-36 physical function subscores ($P=0.046$, $r=-0.716$).

Conclusion: Patients with seropositive AAG had objective evidence of widespread autonomic failure affecting multiple domains which improved significantly after immunotherapy. Quantitative testing using autonomic biomarkers should be used to define initial deficits, guide therapeutic decisions and document treatment response.

Disclosure: Dr Shiwen Koay was funded by the Guarantors of Brain Entry Fellowship. Prof Valeria Iodice, Prof Michael Lunn and Dr Jalesh Panicker are grateful to the NIHR Biomedical Research Centre for their support. We are grateful to the National Brain Appeal Small Acorns Fund for their support with this project.

EPR2012

Autonomic dysfunction in idiopathic Parkinson's Disease, GBA-PD and Multiple System Atrophy

G. Lazzeri¹, A. Carandina², E. Monfrini¹, M. Percetti¹, A. Centola², L. Verdi², M. Vizziello¹, F. Arienti¹, I. Trezzi¹, G. Franco¹, N. Bresolin³, N. Montano², A. Di Fonzo¹, E. Tobaldini²

¹IRCCS Foundation Ca' Granda Ospedale Maggiore Policlinico, Dino Ferrari Center, Milan, Italy; ²Internal Medicine, Policlinico Hospital, Milan, Italy; ³Neurology, University of Milan, Milan, Italy

Background and aims: Autonomic dysfunction is a well-known feature of α -synucleinopathies. Pathogenic and clinical differences between Parkinson's Disease (PD) and Multiple System Atrophy (MSA) have been extensively described in the literature. Conversely, less is known about the impact of glucocerebrosidase (GBA) gene, associated with a more severe disease course in PD, on dysautonomic symptoms.

The aim of the study is to assess the differences of cardiovascular autonomic dysfunction in PD patients, with and without GBA mutations, compared to MSA patients.

Methods: Autonomic cardiac control at rest and during orthostatic challenge in 9 idiopathic PD, 6 GBA-PD and 4 MSA patients was evaluated. ECG and respiration were recorded in supine position for 10 minutes and during active standing for another 10 minutes. Segments of 250 ± 50 beats were selected for the analysis of Heart Rate Variability using two approaches, linear spectral analysis and non-linear symbolic analysis.

Results: Concerning demographic characteristics, the subgroups did not differ significantly in age nor disease duration.

At rest, autonomic parameters were similar in the 3 groups. iPD patients showed a significant increase of heart rate and sympathetic modulation, expressed by 0V%, in response to orthostatic stress. Differently, MSA and GBA-PD patients did not show any significant modification of autonomic parameters during standing. In details, orthostatic challenge caused an higher increase of 0V%, marker of sympathetic modulation, in iPD patients compared to MSA and GBA-PD cases (120% vs 53% and 33%).

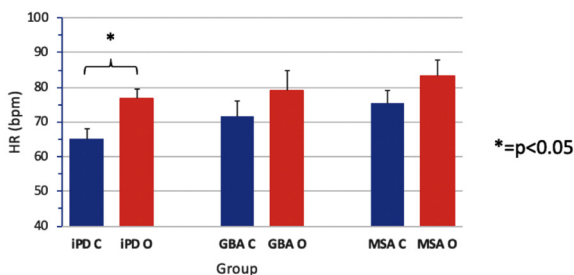

Heart Rate response to orthostatic stress in the 3 subgroups

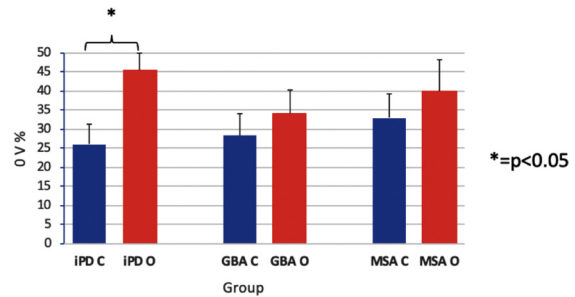

Sympathetic response (0V%) to orthostatic stress in the 3 subgroups

Conclusion: The study suggests that GBA-PD patients show a more severe cardiovascular autonomic dysfunction compared to IPD, similarly to MSA patients.

Disclosure: Nothing to disclose

EPR2013

A clinico-genetic study based on the Innsbruck MSA Registry (IMSA-R)

F. Leys¹, S. Eschlboeck¹, V. Bonifati², J. Zschocke³, R. Granata¹, K. Seppi¹, G.K. Wenning¹, A. Fanciulli¹

¹Department of Neurology, Medical University of Innsbruck, Innsbruck, Austria, ²Department of Clinical Genetics, Erasmus Medical Center, Rotterdam, Netherlands, ³Institute of Human Genetics, Medical University of Innsbruck, Innsbruck, Austria

Background and aims: Multiple system atrophy (MSA) is a rare, rapidly progressive atypical Parkinsonian disorder of the adulthood. Despite considered sporadic, few pedigrees of neuropathologically confirmed MSA with both autosomal dominant and recessive inheritance pattern have been described.

Methods: Here we retrospectively screened the Innsbruck MSA registry (IMSA-R) for patients with possible or probable MSA diagnosed according to the revised MSA consensus criteria (Gilman et al. 2008). In contrast to the consensus criteria we allowed a positive family history for neurodegenerative disorders documented in at least one additional family member of 1st, 2nd or 3rd degree. Clinical demographic characteristics were analysed in our cohort.

Results: 80% (183) out of 230 IMSA-R patients provided information on family history. At least one additional family member with neurodegenerative disorders was documented in 25% (46) of MSA patients. Family history was mostly positive for parkinsonism [56.5% (26)], followed by dementia [28.3% (13)], tremor [19.6% (9)], ataxia [6.5% (3)] and motor-neuron disease [2.2% (1)]. Familial clustering (>2 family members affected by neurodegenerative disease) was observed in 19.6% (9). Genetic screening for hereditary ataxia was performed in 21.7% (10) yielding mostly negative results. The median age at disease onset in MSA patients with positive family history was 53.4 (49.0; 60.8) years, with parkinsonism being the most common onset feature [47.8% (22)].

Conclusion: Although generally considered a sporadic disease, every 4th patient with MSA had a positive family history for neurodegenerative diseases in our cohort. Furthermore, we observed familial clustering in 20% of these patients.

Disclosure: Academic study, no external financial support allotted. The authors declare no conflict of interest. Dr. Leys is supported by the ParkinsonFond Österreich.

EPR2014

Abnormal breathing patterns and their relation to lesion extension and position in patients with acute unilateral lateral medullary infarction

K. Pavšic, J. Pretnar Oblak, L. Dolenc Groselj, F. Bajrovic
Ljubljana, Slovenia

Background and aims: Different breathing abnormalities, from sleep-disordered breathing to overt respiratory failure, have been described in acute unilateral lateral medullary infarction (ULMI). Here we analyzed the relation of specific breathing pattern abnormalities to ULMI lesion location and extension.

Methods: We prospectively monitored breathing patterns using polysomnography (PSG) in 40 patients with MRI-confirmed acute ULMI (70% male, aged 57 (IQR 51-69) years) during the 1st 3 weeks after symptom onset. We compared the breathing patterns among MRI groups according to lesion location and extension. Lesions were categorized vertically into 4 groups according to their extension (localized/extensive: involving ≤ 2 / > 2 horizontal sections, respectively) and involvement of open/closed medulla, and horizontally into anterolateral, lateral or posterior (Figure 1).

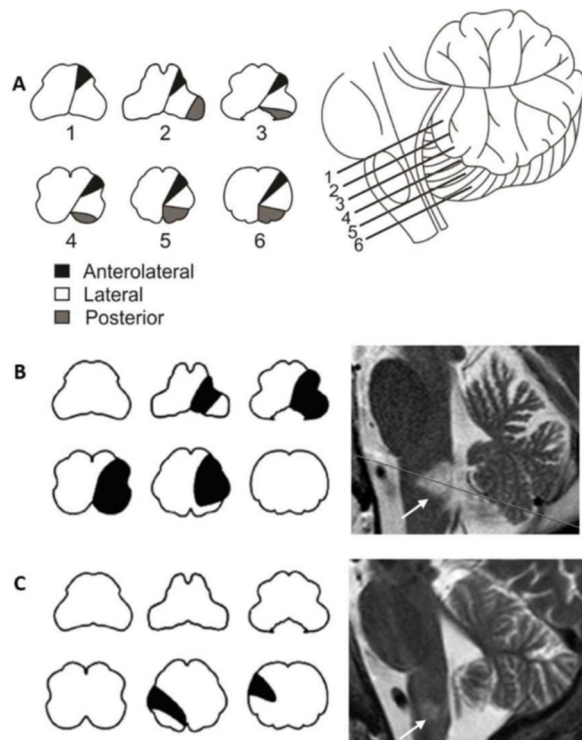

Schematic presentation of lesion mapping. A) Sections 1-3: open medulla, sections 4-6: closed medulla. Shaded areas: horizontal territories. B) Vertically extensive open medulla lesion, involving posterior, lateral and anterolateral horizontal territories. C) Vertically localized closed medulla lesion, involving lateral horizontal territory.

Results: Abnormal breathing patterns of ≥ 10 minutes long episodes were observed in 26 (65%) patients; ataxic in 23 (58%), periodic in 16 (40%) and tachypnea in 8 (20%) (Figure 2). Abnormal breathing patterns occurred more frequently in vertically extensive and localized open medulla lesions than in localized closed medulla lesions ($p=0.027$, Table 1) and in horizontally large lesions involving \geq half of the lateral territory or multiple horizontal territories ($p=0.001$, Table 1). Ataxic breathing was significantly more frequent in patients with concomitant cerebellar lesions compared to pure ULMI (12/15 cases [80%] vs 11/25 cases [44%], respectively, $p=0.046$).

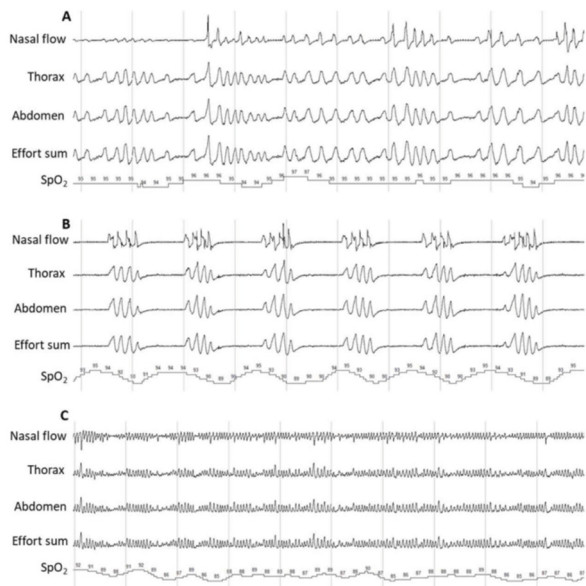

Figure 2. 5-min epochs of PSG recordings representing different abnormal breathing patterns. A) Ataxic breathing. B) Periodic breathing. C) Sustained tachypnea accompanied by low oxygen saturation.

Vertical lesion extension	Extensive inv. open (n=20)	Localized inv. open (n=9)	Extensive restr. to closed (n=5)	Localized restr. to closed (n=6)	p-value
Ataxic	14 (70%)	4 (44%)	4 (80%)	1 (17%)	0.078
Periodic	10 (50%)	3 (33%)	2 (40%)	1 (17%)	0.513
Tachypnea	5 (25%)	2 (22%)	1 (20%)	0 (0%)	0.714
Any abnormal breath. pattern	16 (80%)	5 (56%)	4 (80%)	1 (17%)	0.027

Horizontal lesion extension	P (n=6)	L small (n=10)	L large (n=10)	P+L (n=11)	P+L+AL (n=2)	L+AL (n=1)	p-value
Ataxic	1 (17%)	3 (30%)	8 (80%)	10 (91%)	0 (0%)	1 (100%)	0.001
Periodic	0 (0%)	2 (20%)	5 (50%)	7 (64%)	2 (100%)	0 (0%)	0.019
Tachypnea	1 (17%)	0 (0%)	2 (20%)	4 (36%)	0 (0%)	1 (100%)	0.127
Any abnormal breath. pattern	1 (17%)	4 (40%)	7 (70%)	11 (100%)	2 (100%)	1 (100%)	0.001

Table 1. Frequencies of abnormal breathing patterns in regards to vertical and horizontal lesion extension. P – posterior, L small – lateral lesion involving < half lateral territory, L large – lateral lesion involving \geq half lateral territory, AL – anterolateral.

Conclusion: Majority of our ULMI patients presented with abnormal breathing patterns, which were associated with vertically and/or horizontally extensive lesions as well as involvement of the open medulla. Concomitant cerebellar lesions seemed to contribute to ataxic breathing.

Disclosure: The study was funded by the Slovenian Research Agency (Grants Nos. P3-0171 and P3-0338).

EPR2015

Electrochemical skin conductance as a marker of autonomic failure in patients with Multiple System Atrophy

S. Lloret Perez¹, V. Fabry², F. Ory-Magne³, C. Brefel-Courbon⁴, A. Foubert-Samier⁵, W. Meissner⁶, O. Rascol³, J.-M. Senard³, A. Pavy-Le Traon²

¹Institute of Cardiology Research, National Research Council, Buenos-aires, Argentina, ²Neurology, Toulouse University Hospital, Toulouse, France, ³TOULOUSE, France, ⁴University hospital of Toulouse, Toulouse, France, ⁵French Reference Center for MSA, Department of Neurology, University Hospital of Bordeaux and Institute of Neurodegenerative Diseases, Bordeaux, France, ⁶Bordeaux, France

Background and aims: Multiple System Atrophy (MSA) is a rare neurodegenerative disabling disease combining poorly levodopa-responsive parkinsonism, cerebellar ataxia and autonomic failure (AF). Severe cardiovascular AF is associated with poor prognosis. Since sweating dysfunction is less well known, we investigated the interest of a quick and non-invasive assessment of sweating (Sudoscans[®]) as a marker of AF in MSA.

Methods: 129 patients of the French Reference center for MSA with an annual follow-up including the Unified MSA Rating Scale (UMSARS) and measurements of electrochemical skin conductance (ESC) of feet and hands (Sudoscans[®]) participated to this study. 67 patients had annual follow-up data (mean \pm SD follow-up was 29.2 \pm 18.0 months). Statistical analysis included: (i) correlations between ESC and MSA type, age, disease duration, BP (supine and standing), autonomic symptoms (COMPASS), (ii) comparisons between groups with normal or abnormal ESC, and (iii) multivariate analysis by logistic regression. Relationship between MSA severity progression during follow-up with ESC and other variables were modeled by Generalized Estimating Equation (GEE).

Results: Feet or hand ESC were abnormal at the 1st visit in 72 (57%) and 103 (81%) patients. Abnormal ESC were related to greater systolic BP fall upon standing and UMSARS II scores. Significant and independent predictors of worsening were female gender, a probable diagnosis, longer disease duration and lower feet and hand ESC. Abnormal ESC baseline values were significant predictors of future worsening independently from other factors.

Conclusion: Feet and skin ESC were significantly related to MSA severity and orthostatic hypotension. Furthermore, baseline SUDOSCAN results could predict more severe disease progression.

Disclosure: Nothing to disclose

EPR2016

Temporal Relation of Ictal Asystole to Onset of Syncope in Focal Seizures

A. Van Westrhenen¹, S. Shmueli¹, R. Surges², B. Diehl³, D. Friedman⁴, F. Leijten⁵, G. Van Dijk⁶, R. Thijs¹

¹Department of Epilepsy, Stichting Epilepsie Instellingen Nederland (S.E.I.N.), Heemstede, Netherlands,

²Epileptology, University Clinic Bonn, Bonn, Germany,

³Neurology, UCL Institute of Neurology, London, United Kingdom, ⁴Neurology, NYU, New York City, USA,

⁵Neurophysiology, University Medical Center Utrecht, Utrecht, Netherlands, ⁶Neurology and Clinical

Neurophysiology, Leiden University Medical Center, Leiden, Netherlands

Background and aims: Ictal asystole (IA) is the most common peri-ictal cardiac arrhythmia. IA may cause traumatic falls due to syncope with sudden loss of muscle tone. Pacemaker implantation may only help to prevent syncope in IA if cardioinhibition is the dominant pathomechanism. We investigated the temporal relation between IA and syncope to determine how often IA was the primary cause of syncope [Saal DP;2017].

Methods: Video-EEG databases of the participating centers were searched for subjects with recorded focal seizures and IA, defined as an RR interval of ≥ 3 2nds preceded by heart rate deceleration. We assessed time of onset and duration of asystole and syncope, if present. Presence of syncope was evaluated using video (loss of muscle tone) and EEG (generalized slowing or flattening). We determined that asystole < 3 seconds before syncope could not have been the primary cause of syncope [Saal DP;2017].

Results: We reviewed 39 seizures with IA from 30 subjects (17 male, median age 41 years [range 15-74 years]). Syncope occurred in 23 IA events; in all 21 IA events ≥ 10 seconds and in 2 out of 18 IA events < 10 seconds. IA always preceded syncope. According to the predefined criteria, in three cases IA could not have been the primary cause of syncope.

Conclusion: Our results show that IA is the likely cause of syncope in 20 out of 23 seizures and syncope is more likely to occur in IA events ≥ 10 seconds. Cardioinhibition is an important early but not exclusive mechanism causing syncope in IA.

Disclosure: Nothing to disclose

EPR2017

Abnormal circadian blood pressure and supine hypertension in patients with multiple system atrophy and pure autonomic failure - diagnostic and therapeutic implications.

E. Vichayanrat¹, F. Casolaro¹, J.S. Koay², C. Mathias³, V. Iodice²

¹Autonomic Unit, National hospital for Neurology, London, United Kingdom, ²Queen Square Institute of Neurology, UCL, London, United Kingdom, ³Autonomic & Neurovascular Medicine Centre, Hospital of St John and St Elizabeth, London, United Kingdom

Background and aims: Supine hypertension and reversal of circadian blood pressure (BP) pattern occur in chronic autonomic failure due to multiple system atrophy (MSA) and pure autonomic failure (PAF). 24-hour ambulatory BP monitoring (24hr-ABPM) has been specifically modified to additionally assess both supine hypertension and orthostatic hypotension (OH) during daily activities in patients with MSA and PAF. This has not been compared in these disorders alongside with BP and heart rate (HR) responses during head-up tilting (HUT). The aim of this study is to characterise supine hypertension and circadian blood pressure rhythm in MSA and PAF patients.

Methods: 45 patients (26 MSA, 19 PAF) without anti-hypotensive medications underwent cardiovascular autonomic testing and 24hr-ABPM. Age, gender, clinical features and disease duration were recorded with BP and HR responses during HUT and 24-hr ABPM.

Results: Both groups had confirmed autonomic failure and OH during HUT, greater in PAF ($p < 0.01$) despite similar disease duration. With 24hr-ABPM, nocturnal hypertension was present in $> 25\%$ of both groups. Supine hypertension was present in 10/26 (38%) MSA and 10/19 (53%) PAF. A higher proportion of PAF had abnormally reversed circadian rhythms compared to MSA (68% vs 54%, respectively), without statistical significance. Nocturnal hypertension was significantly correlated with longer disease duration in MSA ($p = 0.03$).

Conclusion: Supine hypertension and reversed circadian BP rhythms are present in MSA and PAF. 24hr-ABPM does not differentiate between the groups. However, it provides information contributing to risk evaluation of supine hypertension, and should aid therapeutic intervention and efficacy of different (non-pharmacological and drug) measures in MSA and PAF.

Disclosure: Dr Shiwen Koay was funded by the Guarantors of Brain Entry Fellowship. Dr Valeria Iodice is grateful to the NIHR Biomedical Research Centre for their support.

EPR2018

Effects of Once-Daily Amprelosetine (TD-9855), a Norepinephrine Reuptake Inhibitor, on Blood Pressure in Subjects With Symptomatic Neurogenic Orthostatic Hypotension Associated With Synucleinopathies

H. Kaufmann¹, I. Biaggioni², W. Wang³, B. Haumann³, R. Vickery⁴

¹Department of Neurology, NYU Medical Center, New York, USA, ²Department of Medicine, Vanderbilt University Medical Center, Nashville, USA, ³Theravance Biopharma US, South San Francisco, USA, ⁴Theravance Biopharma Ireland Limited, Dublin, Ireland

Background and aims: In neurogenic orthostatic hypotension (nOH), standing blood pressure (BP) falls due to inadequate norepinephrine (NE) release. Amprelosetine, a novel, long-acting, NE reuptake inhibitor, has shown durable symptom improvement in subjects with nOH associated with synucleinopathies. The objective of this study was to evaluate BP regulation in subjects with symptomatic nOH treated with open-label amprelosetine.

Methods: In a phase 2 study, subjects received amprelosetine once-daily (3–20mg) for up to 20 weeks, with 4-week follow-up after amprelosetine withdrawal. Assessments included Orthostatic Hypotension Symptom Assessment Item 1 score (OHSA#1; dizziness, lightheadedness, feeling faint); standing/sitting/supine systolic BP (SBP); standing duration; and plasma NE.

Results: 17 symptomatic subjects (baseline OHSA#1 score >4) were enrolled (mean age, 65 years). Mean increase in 3-minute standing SBP from baseline at Weeks 4 and 20 was 9.0mmHg and 10.8mmHg, respectively; >50% of subjects maintained SBP >80mmHg. Sitting SBP changes were less, with little change in supine SBP. At Week 4, 67% of subjects could stand for >5 mins, 31% improvement from baseline. NE plasma levels rose from pre-dose to Week 4 (1664.93–2231.67pmol/l). Baseline NE plasma levels correlated with standing BP increase. Amprelosetine was well tolerated.

Durable symptom improvement in nOH was accompanied by increase in standing and sitting SBP, standing duration, and NE plasma levels, with little effect on supine SBP.

Conclusion: These encouraging findings on BP regulation in nOH with amprelosetine treatment for up to 5 months are being evaluated in ongoing Phase 3, double-blind, confirmatory studies in subjects with nOH.

Disclosure: R Vickery is an employee of Theravance Biopharma Ireland Limited and stockholder of Theravance Biopharma US, Inc.

EPR2019

Automated calculation of baroreflex sensitivity (BRS) indices

N. Visnjic¹, I. Mostak¹, T. Mutak¹, D. Pucic¹, A. Junaković², I. Adamec², M. Krbot Skoric², M. Habek¹
¹University of Zagreb, School of Medicine, Zagreb, Croatia, ²University Hospital Centre Zagreb, Zagreb, Croatia

Background and aims: Baroreflex sensitivity (BRS) indices provide information about the sympathetic adrenergic function by defining the parameters of the blood pressure (BP) response to Valsalva manoeuvre (VM). Indices are usually calculated manually which is time consuming and dependent on the subjective assessment and subject to human error. The aim of this research was to objectify the method with automatization of calculation of BRS indices.

Methods: In 69 individuals with a history of vasovagal syncope and no other neurological or systemic illnesses (mean age 47.04±11.18, 55 females) autonomic nervous system testing that included BP response to VM was performed. For each participant BRS indices were calculated from the systolic BP curves during the VM: BRSa1, alpha BRSa (α -BRSa) and beta BRSa (β -BRSa). BRS indices were calculated manually and through an automated process with MATLAB R2019b. Automatization software was created according to previously known formulas for BRS indices, with additional calculation of average baseline BP values.

Results: Median values for manually calculated indices were 21.45 for BRSa1, 7.01 for α -BRSa, and 1.37 for β -BRSa, and for automatically calculated 23.91 for BRSa1, 6.99 for α -BRSa, and 1.19 for β -BRSa. There was statistically significant correlation between the manually and automatically calculated results for all three coefficients (BRSa1: rs=0.920, p<0.001; α -BRSa: rs=0.879, p<0.001; β -BRSa: rs=0.889, p<0.001).

Conclusion: Automatization of BRS indices calculation shows results highly correlated with manually calculated indices, reduces time required for calculation and reduces the impact of subjective human component on the calculations.

Disclosure: Nothing to disclose

EPR2020

Cognitive impairment in multiple system atrophy versus Lewy body disorders

L. Weißmante¹, K. Kerer¹, F. Leys¹, C. Raccagni¹, S. Eschlboeck¹, C. Kaindlstorfer¹, V. Sidoroff¹, F. Krismer¹, R. Granata¹, M. Perez², J.A. Palma², H. Kaufmann², L. Norcliffe-Kaufmann², W. Poewe¹, K. Seppi¹, G.K. Wenning¹, A. Fanciulli¹

¹Department of Neurology, Medical University of Innsbruck, Innsbruck, Austria, ²Department of Neurology, New York University School of Medicine, New York, USA

Background and aims: Dementia is considered a non-supportive diagnostic feature for multiple system atrophy (MSA). Nevertheless, post-mortem verified dementia with Lewy bodies and Parkinson's disease masquerade as MSA. Cognitive impairment (CI), especially executive dysfunction, may occur in MSA patients. It is, however, unclear whether CI manifests in early disease stages.

Objective: To compare the prevalence of CI in MSA versus other Lewy Body disorders (LBD), including dementia with Lewy bodies and Parkinson's disease, in early (<3 years from symptom onset) versus more advanced disease stages (≥3 years from symptom onset).

Methods: A total of 364 patients (LBD: n=83; MSA: n=281) of the natural history study of synucleinopathies register have been analysed. Consensus diagnostic criteria for dementia with Lewy bodies, Parkinson's disease and MSA were applied. To assess CI, the Montreal Cognitive Assessment (MoCA) has been used.

Results: In early disease stages, median MoCA scores did not differ significantly between MSA and LBD. In advanced disease stages, MSA patients had a significantly higher median MoCA score compared to LBD patients (27 versus 25, p=0.006).

Table 1: Comparison of the median MoCA Scores of Lewy Body disorders versus MSA patients at early and advanced disease stages

Early disease stage (<3 years disease duration)			
	Lewy Body disorders	MSA	P*
No. of patients	15 (16.5%)	76 (83.5%)	
Female	6 (40%)	28 (36.8%)	0.817
Age	74.00 (66.00; 77.00)	61.00 (55.00; 66.75)	< 0.001
MoCA	27.00 (23.00; 30.00)	29.00 (26.25; 30.00)	0.784
Advanced disease stage (≥3 years disease duration)			
	Lewy Body disorders	MSA	P*
No. of patients	68 (24.9%)	205 (75.1%)	
Female	15 (22.1%)	92 (44.9%)	0.001
Age	69.50 (62.25; 75.00)	61.00 (56.00; 67.00)	< 0.001
MoCA	25.00 (20.25; 28.00)	27.00 (23.00; 29.00)	0.006

Dichotomous variables are reported by frequency (percentage), quantitative variables by median (1st quartile; 3rd quartile). * Gender was tested with the Pearson's Chi-Square-Test, Age with the T-Test and MoCA with the Mann-Whitney-Test; No.: Number; MSA: Multiple System Atrophy; MoCA: Montreal cognitive Assessment

Comparison of the median MoCA Scores of LBD versus MSA patients at early and advanced disease stages

Conclusion: In patients with longer disease duration severity of CI helps to differentiate LBD from MSA.

Disclosure: Nothing to disclose

Cerebrovascular diseases 3

EPR2021

The clinical benefit of mechanical thrombectomy after 6 to 24 hours of acute large vessel occlusion in very elderly stroke patients.

J.-G. Kim¹, B.S. Kang²

¹Neurology, Jeju National University Hospital, Jeju, Jeju, Korea, Republic of, ²Neurology, Yangpyeong Hospital, Yangpyeong, Korea, Republic of

Background and aims: Previous studies evaluating 90-day outcomes of acute large vessel occlusion patients with late window in elderly patients ≥ 80 years have been limited to small numbers undergoing endovascular reperfusion therapy.

Methods: Using a multicenter prospective stroke registry adult patients (aged ≥ 18 years) with acute large vessels occlusion in patients with ischemic stroke, who were hospitalized in one of the 15 participating centers between March 2010 and December 2018. And patients who underwent endovascular reperfusion therapy at 6 to 24 hours and had available measured 90-days modified Rankin scale was collected for this study. We compared neurological and functional outcomes between patients in patients ≥ 80 vs. < 80 years.

Results: We included 146 patients with ≥ 80 (mean age 83.4 ± 3.3 , 38.4% males) and compared them to 758 patients with < 80 years (mean age 65.4 ± 11.5 , 66.6 % males). Only eighteen percent of our elderly cohort achieved good 90-day mRS compared to 45.1% in younger patients ($p < 0.001$). 20.5% percent of elderly patients died compared to 11.7% ($p = 0.006$), respectively of younger patients. Old age (OR 3.99; 95% CI 1.11–17.57, $p < 0.046$) and higher baseline NIHSS (OR 1.10; 95% CI 1.01–1.20, $p < 0.03$) correlated with poor prognosis in study patients.

Conclusion: Mechanical thrombectomy performed late time window was significantly less effective in older patients. A more careful approach is needed before performing the EVT in these patients.

Disclosure: Nothing to disclose

EPR2022

Endovascular treatment in orally anticoagulated stroke patients: An analysis from the German Stroke Registry-Endovascular Treatment

C. Küpper¹, K. Feil¹, F.A. Wollenweber¹, S. Tiedt¹, M. Herzberg², F. Dorn², T. Liebig², M. Dieterich¹, L. Kellert¹

¹Department of Neurology, Ludwig Maximilians University, Munich, Germany, ²Department of Neuroradiology, Ludwig Maximilians University, Munich, Germany

Background and aims: Endovascular treatment (ET) in orally anticoagulated (OAC) patients has not yet been evaluated in randomized clinical trials and data regarding this issue are sparse.

Methods: We retrospectively analyzed the German Stroke Registry-Endovascular Treatment (GSR-ET). Primary outcomes were successful recanalization defined as modified thrombolysis in cerebral infarction (TICI 2b-3), good outcome at 3 months according to modified Rankin scale (mRS 0-2 or back to baseline) and intracranial hemorrhage (ICH) until hospital discharge.

Results: Out of 2521 patients, 442 (17.6%) were treated with OAC, 201 (8.0%) with Vitamin-K-antagonists (VKA), and 241 (9.6%) with non-Vitamin-K-antagonist oral anticoagulants (NOAC). OAC-patients were older (VKA 77.6 years, NOAC 76.2 years vs no-OAC 71.6 years, $p < 0.005$), had more often known atrial fibrillation (88.1%, 85.3% vs 30.9%, $p < 0.005$) and a higher rate of arterial hypertension (85.0%, 83.6% vs 73.7%, $p < 0.005$). With regards to efficacy, the rate of mTICI 2b-3 were similar among the 3 groups (82.7%, 85.5% vs 82.7%, $p = 1.00$ and 0.57). On day 90, good outcome was less frequent in OAC patients (28.4%, 31.1% vs 40.9%, $p < 0.005$ and < 0.05). ICH rates were similar among the 3 groups (12.1%, 12.4% vs 10.4%, $p = 1.00$ and $p = 0.86$). (For patient details see table 1) Regression analysis revealed no influence of OAC status neither on good outcome (OR 1.03, 95% CI 0.99-1.08) nor on ICH (OR 1.03, 95% CI 0.94-1.05).

Parameter	No OAC	Thrombolysis	p-value	NOAC	p-value	Missing values
n (%)	2079 (82.5)	201 (8.0)	n. a.	241 (9.6)	n. a.	0 (0)
Age, mean \pm SD	71.6 \pm 13.4	77.6 \pm 10.7	< 0.005	76.2 \pm 10.5	< 0.005	0 (0)
Female, n (%)	1051 (49.6)	114 (56.7)	0.308	127 (52.7)	0.722	0 (0)
Anticoagulant therapy, n (%)	790 (38.0)	12 (6.0)	< 0.005	30 (12.4)	< 0.005	0 (0)
Arterial hypertension, n (%)	1527 (73.7)	170 (85.0)	< 0.005	199 (83.6)	< 0.005	12 (5.0)
Diabetes mellitus, n (%)	414 (20.0)	44 (21.9)	1	69 (28.6)	< 0.005	8 (3.3)
Hypertension, n (%)	868 (41.4)	82 (40.7)	0.004	93 (38.4)	0.008	18 (7.5)
Atrial fibrillation, n (%)	638 (30.9)	177 (88.1)	< 0.005	203 (85.3)	< 0.005	18 (7.4)
History of smoking, n (%)	464 (22.4)	22 (10.9)	< 0.005	38 (15.8)	0.008	320 (12.7)
psfL, median	0 (0, 1)	0 (0, 2)	< 0.005	0 (0, 1)	< 0.005	90 (3.7)
NIHSS, median	15 (10, 19)	15 (11, 19)	0.788	16 (12, 20)	< 0.005	30 (12.2)
ASPECTS, median	9 (8, 10)	9 (8, 10)	0.384	9 (8, 10)	0.384	584 (23.2)
Reperfusion rate (mTICI)	1688 (82.7)	162 (82.7)	1	206 (85.5)	0.37	44 (1.7)
30-90, n (%)	325 (15.6)	25 (12.4)	1	25 (10.4)	0.006	0 (0)
ICH until discharge, n (%)	795 (40.8)	50 (28.4)	< 0.005	64 (28.1)	< 0.05	399 (15.8%)

Table 1: Baseline patient, stroke, imaging and treatment characteristics. Abbv.: OAC=oral anticoagulation, NOAC=non-Vitamin K-antagonist oral anticoagulant, SD=standard deviation, psfL=perceived modified Rankin scale, NIHSS=National Institutes of Health Stroke Scale, ASPECTS=Alberta Stroke Program Early CT Score, mTICI=modified thrombolysis in cerebral infarction, ICH=intracranial hemorrhage

Table 1

Conclusion: Data from daily routine suggest that ET can be performed successfully and safely in LVO stroke patients treated with OAC.

Disclosure: Nothing to disclose

EPR2023

Atrial fibrillation as the hidden cause of cryptogenic stroke The Nordic Atrial Fibrillation and Stroke Study (NOR-FIB) – an interim analysis

A.T. Lambert¹, B. Ratajczak-Tretel¹, V. Bjerkeli², D. Russell³, H. Ihle-Hansen⁴, H. Næss⁵, V. Novotny⁶, T.C. Truelsen⁷, K.L. Ægidius⁸, H. Tobro⁹, S.B. Krogseth¹⁰, H. Ihle-Hansen¹¹, C. Kruuse¹², K. Arntzen¹³, G. Eldøen¹⁴, A. Gulsvik¹⁵, R. Ul-Haq Qazi¹⁵, M. Rezai¹⁶, H. Khan Ahmed¹⁶, J. Sømarn¹⁷, H.M. Otterholt Bekkeseth¹⁷, S. Ingebrigtsen¹⁸, G.A. Høie¹⁹, D. Atar²⁰, A.H. Aamodt³

¹Department of Neurology, Østfold Hospital Trust, Grålum, Norway, ²Research Institute of Internal Medicine, Oslo University Hospital, Oslo, Norway, ³Department of Neurology, Oslo University Hospital, Oslo, Norway, ⁴Department of Neurology, Stroke Unit, Oslo University Hospital, Oslo, Norway, ⁵Department of Neurology/ Department of Clinical Medicine, Haukeland University Hospital/University of Bergen, Bergen, Norway, ⁶Department of Neurology, Haukeland University Hospital, Bergen, Norway, ⁷Department of Neurology, Rigshospitalet University Hospital, Copenhagen, Denmark, ⁸Department of Neurology, Bispebjerg Hospital, Bispebjerg, Denmark, ⁹Department of Neurology, Skien Hospital, Skien, Norway, ¹⁰Department of Neurology, Vestfold Hospital, Tønsberg, Norway, ¹¹Department of Internal Medicine, Vestre Viken Hospital Trust, Bærum, Norway, ¹²Department of Neurology, Herlev Gentofte Hospital, Herlev, Denmark, ¹³Department of Neurology, Norland Hospital, Bodø, Norway, ¹⁴Department of Neurology, Møre og Romsdal Hospital Trust, Molde, Norway, ¹⁵Department of Internal Medicine, Diakonhjemmet Hospital, Oslo, Norway, ¹⁶Department of Neurology, Stavanger University Hospital, Stavanger, Norway, ¹⁷Department of Neurology, Innlandet Hospital Trust, Lillehammer, Norway, ¹⁸Department of Neurology, University Hospital of North Norway, Tromsø, Norway, ¹⁹Department of Cardiology, Østfold Hospital Trust, Grålum, Norway, ²⁰Department of Cardiology B, Div. of Medicine, University of Oslo, Oslo, Norway

Background and aims: Studies with insertable cardiac monitors (ICMs) show that up to 30% of cryptogenic stroke patients have an underlying atrial fibrillation (AF) that would not be detected with standard clinical follow-up. There is, however, no consensus about the timing and duration of rhythm monitoring. Furthermore, there are no specific biomarkers widely used in clinical praxis for selecting patients for prolonged cardiac rhythm monitoring. **Methods:** NOR-FIB is an international multi-center prospective observational study of the occurrence of AF in cryptogenic stroke / TIA patients with ICMs for 12 months. Blood samples measuring biomarkers are taken in the acute phase and at 12 months' follow-up. Patient inclusion started in January 2017 and will continue until March 2020. Patients are included within 14 days from symptom onset. Threshold for the AF or atrial flutter diagnosis is set to 2 minutes.

Results: By January, a total of 235 patients have been included in 16 participating centres. 7 patients were excluded due to reclassification to another stroke subtype after acquiring additional data. 1 patient with neoplasm was incorrectly classified as having ischemic stroke at the 1st evaluation. 2 patients have experienced adverse events that required earlier removal of the device and there was registered 1 spontaneous explantation. From 227 studied patients, AF or atrial flutter was detected in 54 patients, resulting in detection rate of 23.8%.

Conclusion: ICMs are effective in detecting atrial fibrillation in patients with cryptogenic stroke and are associated with low complication rate. New interim analyses and update will be presented.

Disclosure: Nothing to disclose

EPR2024

Brain imaging as the predictor of atrial fibrillation The Nordic Atrial Fibrillation and Stroke Study (NOR-FIB)

A.T. Lambert¹, B. Ratajczak-Tretel¹, M. Lambert², V. Bjerkeli³, H. Ihle-Hansen⁴, H. Næss⁵, V. Novotny⁶, T.C. Truelsen⁷, K.L. Ægidius⁸, H. Ihle-Hansen⁹, H. Tobro¹⁰, S.B. Krogseth¹¹, C. Kruuse¹², K. Arntzen¹³, G. Eldøen¹⁴, A. Gulsvik¹⁵, R. Ul-Haq Qazi¹⁵, M. Rezai¹⁶, H. Khan Ahmed¹⁶, J. Sømmark¹⁷, H.M. Otterholt Bekkeseth¹⁷, S. Ingebrigtsen¹⁸, G. Høie¹⁹, D. Atar²⁰, A.H. Aamodt²¹

¹Department of Neurology, Østfold Hospital Trust, Grålum, Norway, ²Department of Radiology, Oslo University Hospital, Oslo, Norway, ³Research Institute of Internal Medicine, Oslo University Hospital, Oslo, Norway, ⁴Department of Neurology, Stroke Unit, Oslo University Hospital, Oslo, Norway, ⁵Department of Neurology/Department of Clinical Medicine, Haukeland University Hospital/University of Bergen, Bergen, Norway, ⁶Department of Neurology, Haukeland University Hospital, Bergen, Norway, ⁷Department of Neurology, Rigshospitalet University Hospital, Copenhagen, Norway, ⁸Department of Neurology, Bispebjerg Hospital, Bispebjerg, Denmark, ⁹Internal medicine, Bærum Hospital, Bærum, Norway, ¹⁰Department of Neurology, Skien Hospital, Skien, Norway, ¹¹Department of Neurology, Vestfold Hospital, Tønsberg, Norway, ¹²Department of Neurology, Herlev Gentofte Hospital, Copenhagen, Denmark, ¹³Department of Neurology, Norland Hospital, Bodø, Norway, ¹⁴Department of Neurology, Møre og Romsdal Hospital Trust, Molde, Norway, ¹⁵Department of Internal Medicine, Diakonhjemmet Hospital, Oslo, Norway, ¹⁶Department of Neurology, Stavanger University Hospital, Stavanger, Norway, ¹⁷Department of Neurology, Innlandet Hospital Trust, Lillehammer, Norway, ¹⁸Department of Neurology, University Hospital of North Norway, Tromsø, Norway, ¹⁹Department of Cardiology, Østfold Hospital Trust, Grålum, Norway, ²⁰Department of Cardiology B, Div. of Medicine, University of Oslo, Oslo, Norway, ²¹Department of Neurology, Oslo University Hospital, Oslo, Norway

Background and aims: The presence of simultaneous acute infarctions in different arterial territories and affection of predominantly anterior circulation is suggestive of cardioembolism. In the ongoing Nordic Atrial Fibrillation and Stroke study (NOR-FIB) we evaluate the incidence of atrial fibrillation (AF) in patients with cryptogenic stroke using insertable cardiac monitors. The purpose of the single-center interim analysis was to evaluate whether there is a specific imaging pattern associated with post-stroke detected AF or atrial flutter lasting at least 2 minutes.

Methods: 86 patients were included by 8th January 2020 in Østfold Hospital Trust with 51 patients concluding the 1-year observation period. 1 patient was excluded. Brain MRIs or CTs were evaluated for the presence and localization of acute and chronic ischemic lesions. T-test for numerical and Chi-Square test for categorical variables were used.

Results: 16 patients had newly diagnosed AF or atrial flutter within 12 months (detection rate of 32%). Median (IQR) time to inclusion after the index event was 9 (7-13) days and to AF detection 23.5 (7.25-156.25) days. No sex differences between patients with and without AF were observed but patients with AF were significantly older ($p=0.005$). There was no specific imaging pattern of acute lesions associated with AF. Previous ischemic lesions in posterior circulation and particularly cerebellar lesions were significantly associated with AF [OR 5.8 95% CI (1.482, 22.694) and OR 6.2 95% CI (1.305,29.459) respectively].

Conclusion: Previous infarctions in posterior circulation and especially cerebellum were suggestive of underlying AF. New interim analyses with updated results including other markers will be presented.

Disclosure: Nothing to disclose

EPR2025

Cognitive Outcome after Carotid Endarterectomy in Patients with Carotid Artery Stenosis

S. Lattanzi¹, L. Carbonari², G. Pagliariccio², M. Silvestrini¹

¹Marche Polytechnic University, Ancona, Italy, ²Vascular Surgery, Ospedali Riuniti of Ancona, Ancona, Italy, Ancona, Italy

Background and aims: The effect of carotid revascularization on the neurocognitive functioning remains elusive. The study aimed to evaluate the change in cognitive performance and its predictors in patients with symptomatic internal carotid artery (ICA) stenosis undergoing carotid endarterectomy (CEA).

Methods: Patients with history of transient ischemic attack within the past 6 months and ipsilateral high-grade stenosis of ICA undergoing CEA were prospectively enrolled. Cerebral hemodynamics was assessed by cerebral vasomotor reactivity (CVR) measured through transcranial Doppler ultrasonography. Colored Progressive Matrices plus Complex Figure Copy Test, and phonemic plus categorical Verbal Fluency tests were performed to assess right and left hemisphere cognitive functions, respectively. Cerebral hemodynamics and cognitive functions were assessed before and 6 months after CEA.

Results: 183 patients were included. The mean age was 73.1 (6.9) years. At 6 months from CEA, cerebral hemodynamics and neurocognitive functioning were significantly improved. The performance change in cognitive tests exploring the revascularized hemisphere was inversely associated with pre-operative ipsilateral CVR and positively associated with the improvement in cerebral hemodynamics. At the multivariable analysis, the cognitive improvement was associated with exhausted CVR ($\beta=2.36$, 95% CI 0.37- 4.35; $p=0.020$) and mean velocity of middle cerebral artery below normal values ($\beta=4.47$, 95% CI 2.66-6.28; $p<0.001$) on the side of ICA stenosis before CEA.

Conclusion: In patients with symptomatic high-grade ICA stenosis, cognitive performance was enhanced at 6 months since CEA. The cognitive improvement was related to the increase in CVR on the side of stenosis correction and predicted by baseline cerebral hemodynamic status.

Disclosure: Nothing to disclose

EPR2026

Stroke patients' adherence to direct oral anticoagulants – preliminary results from the MAAESTRO Study

V. Albert¹, A. Polymeris², F. Dietrich¹, S.T. Engelter³, K. Herberger¹, P. Lyrer², I. Arnet¹

¹Pharmaceutical Care Research Group, Pharmaceutical Sciences, Pharmazentrum, University of Basel, Basel, Switzerland, ²Department of Neurology and Stroke Center, University Hospital Basel and University of Basel, Basel, Switzerland, ³Neurology and Neurorehabilitation, University Department of Geriatric Medicine Felix Platter and University of Basel, Basel, Switzerland

Background and aims: Non-adherence to direct oral anticoagulants (DOACs) is a matter of concern, especially in secondary stroke prevention. Here, we present preliminary results on stroke patients' adherence to DOACs from the MAAESTRO study's observational phase.

Methods: MAAESTRO includes DOAC-treated AF patients with a recent ischemic stroke. Adherence is measured electronically with the Time4Med™ device, on which patients self-register their medication intakes by pressing a button. Taking adherence was calculated as (total number of recorded intakes)/(total number of prescribed doses). Timing adherence was defined as (total number of intakes recorded within 25% of the average dosing time)/(total number of prescribed doses). Drug holidays were defined as ≥ 3 consecutive days without recorded intake.

Results: We report on the 1st 28 patients who completed the 6-month observational phase (36% female, median age 77.5, median CHA2DS2-VASc score 5). 21 patients (75%) took a twice-daily DOAC and 17 patients (60.7%) used a pillbox. The median (IQR) taking and timing adherence were 94.1% (90.8-96.4) and 92.3% (88.8-95.5) respectively (Figure). Among patients with a twice-daily DOAC, taking adherence in the morning was significantly higher than in the evening (95.2% vs. 93.4%, $p=0.02$). 10 patients (36%) had at least one drug holiday. There was 1 recurrent stroke in a patient with 75.5% taking adherence and concomitant large artery atherosclerosis.

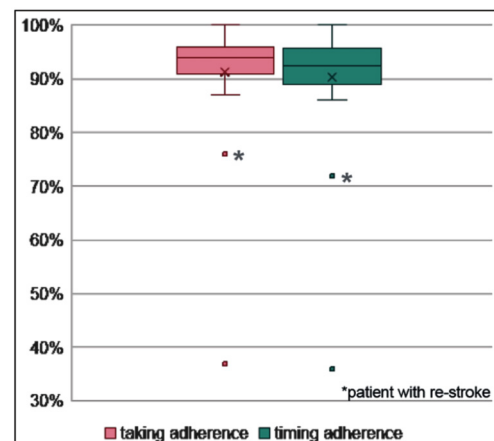

Taking and timing adherence of 28 MAAESTRO patients

Conclusion: Stroke patients showed high adherence rates to DOACs. However, the lower adherence to evening intakes among patients with twice-daily DOACs and the high number of patients with drug holidays are alarming.

Disclosure: Nothing to disclose

EPR2027

Clinical features and frequency of paediatric stroke code. An uncommon emergency.

R.J. Martínez Marín¹, B. Fuentes Gimeno¹, J.A. Ruiz², C. Verdú³, P. Tirado⁴, E. Diez Tejedor¹

¹Neurology, Hospital Universitario La Paz, Madrid, Spain,

²Paediatric Urgency service, Hospital La Paz, Madrid,

Spain, ³Paediatric Intensive Care Unit, Hospital La Paz,

Madrid, Spain, ⁴Neuropaediatric division, Hospital La Paz, Madrid, Spain

Background and aims: Our aim is to analyse the frequency, clinical features and diagnosis of extrahospitalary stroke code at pediatric age (from 1 month to 16 years-old) in a stroke centre with a multidisciplinary paediatric stroke management pathway attending a total population of about 500,000 in-habitants .

Methods: Retrospective analysis of all the consultations from the pediatric emergency department to the on-duty neurologist selecting those corresponding to extrahospitalary stroke code between January 2014 to March 2018. We analysed demographic data, final diagnosis and treatments.

Results: A total of 204 consultations were analysed, of which 22 (10.7%) were activated as stroke codes (6 cases per year on average). The diagnosis was confirmed in 7 children (31.8%), with 2 hemorrhagic (29 %) and 5 ischemic strokes (71 %). The mean door-to-neuroimaging time was 177 minutes (IQR 267) and the mean NIHSS was 11 (IQR 10). 2 ischemic stroke patients out of 5 (40%) were treated with recanalization therapies: 1 patient with intravenous thrombolysis and both of them with mechanical thrombectomy. The main diagnosis in the group of patients without confirmed stroke was migraine (7 out of 15 patients).

Conclusion: The paediatric stroke code is an uncommon emergency in a stroke centre, being the migraine the main stroke mimic. The paediatric stroke code facilitates an early evaluation and the proper indication of recanalization treatment for ischemic stroke.

Disclosure: Nothing to disclose

EPR2028

Extracellular vesicles as circulating biomarkers linked to intracerebral haemorrhage severity and outcome.

M. Alonso de Leciñana, R.J. Martínez Marín, F. Laso García, M.C. Gómez de Frutos, L. Diekhorst, L. Otero Ortega, R. Gutierrez Zuñiga, J. Rodríguez Pardo de Donlenbún, R. Rigual Bobillo, B. Fuentes Gimeno, E. Diez Tejedor, M. Gutiérrez Fernández
Neuroscience and Cerebrovascular Research Laboratory, Neurosciences Area., Hospital Universitario La Paz. IdiPAZ (Health Research Institute). Universidad Autónoma de Madrid, Madrid, Spain

Background and aims: After intracerebral haemorrhage (ICH), extracellular vesicles (EVs) can be released from any type of cell, that could reflect the severity of the process but also the underlying restorative processes. We explore the relationship between circulating EVs with the severity and functional outcome of ICH.

Methods: Observational prospective study including patients with ICH. Demographics, risk factors, comorbidities (Charlson index), etiology, ICH volume, clinical severity according to NIHSS score at baseline, 24 hours and 7 days [categorized as mild (<4), moderate (5-15) or severe (>15)] and functional outcome (mRS) at 7 blood samples at 24-48h and at 5-7 days (ExoQuick Kit) and quantified by ELISA.

Results: 28 patients were included. 18 (62%) men; age [median (IQR)]: 70 (22.75); NIHSS [median (IQR)] at baseline: 12 (12), at 24h: 8.5 (10.5), at 7d: 7.5 (8.75). The number of EVs at 24h was higher in the most severely affected patients ($p=0.035$, Kruskal Wallis test) and a significant correlation between the number of EVs and NIHSS scores at 24h was found ($p=0.039$, Spearman's Rho). At 7 days, there was a decrease in the number of EVs, that was significantly greater in patients with mRS 0-2 at 3 months at 3 months ($p=0.017$, Wilcoxon rank-sum test).

Conclusion: This study suggests a relationship between the release of EVs with the severity and outcome of ICH. These findings deserve further research on the role of EVs as a prognostic biomarker of ICH.

Disclosure: Nothing to disclose

EPR2029

After stroke, apraxia of eyelid opening is associated with high morbidity and right hemispheric infarctions

V. Nersesjan¹, P. Martens², T.C. Truelsen¹, D. Kondziella¹
¹Neurology, Rigshospitalet, University hospital, Copenhagen, Denmark, ²Neuro-Radiology, Rigshospitalet, University hospital, Copenhagen, Copenhagen, Denmark

Background and aims: Apraxia of eyelid opening (AEO) refers to impaired voluntary eyelid elevation of presumed supranuclear origin. It is well described in neurodegenerative disorders and traumatic frontal lobe injury, but the frequency of AEO in stroke is unknown.

Methods: To investigate the prevalence of AEO after stroke, we consecutively enrolled stroke patients with an anterior circulation occlusion admitted for acute endovascular thrombectomy (EVT) to the Department of Neurology, Rigshospitalet, Copenhagen University Hospital. Exclusion criteria were posterior circulation stroke, impairment of consciousness and a history of other eyelid disorder. Patients were systematically screened for AEO, conjugated gaze palsies and cortical ptosis within 48 hours after EVT. Integrity of the pupillary light reflex was verified by automated pupillometry. CT of the brain 24 hours after thrombectomy were analyzed for stroke location by an independent neuroradiologist.

Results: 98 patients with anterior circulation large vessel occlusions were included. AEO was present in 6 patients, conjugated gaze palsy in 37 and cortical ptosis in 16. 54 did not have eye symptoms. AEO was associated with high National Institute of Health Stroke Scale and Modified Ranking Scale scores ($p<0.01$). AEO and conjugated gaze palsy were associated with right hemispheric infarctions ($p<0.01$).

Conclusion: AEO is frequent and underreported in acute large vessel stroke. Recognition of AEO is important because it signals increased mortality and morbidity. AEO was associated with right hemispheric infarctions, suggesting that supranuclear eyelid control may have a right hemispheric dominance.

Disclosure: Nothing to disclose

EPR2030

Withdrawn

EPR2031

Analysis of 13 Cases of adult PCNSV

H. Onomura¹, K. Kunitake¹, R. Inagaki¹, S. Furukawa¹,
H. Moriyoshi², A. Ogura², S. Nishida¹, Y. Ito¹

¹Neurology, Toyota Memorial Hospital, Toyota, Japan,

²COM—Neurology, Nagoya University Graduate School of
Medicine, Nagoya-city Aichi, Japan

Background and aims: Primary central nervous system vasculitis (PCNSV) is a rare but a well-recognized cause of neurological injury. We aim to explore characteristics and outcomes of PCNSV diagnosed patients.

Methods: Total of 13 cases diagnosed as PCNSV from 2011 to 2019 in our hospital were enrolled and followed up for more than 3 months. Clinical, laboratory, radiographic, histological and therapeutic data were collected and analyzed. We differentiated patients into 2 groups due to size of involved vessels: large/proximal (angiogram confirmed) and small/distal vessel group (biopsy confirmed).

Results: 7 presented with focal neurologic deficits due to stroke, 6 with cognitive dysfunction, 5 with headache, 1 seizure and 1 palinopisa. 6 were diagnosed by brain biopsy with no findings of angiogram (small/distal vessel group) and 6 by angiogram only (large/proximal vessel group). Patients in small/distal vessel group frequently had cognitive dysfunction at presentation, radiologically leptomeningeal gadolinium-enhanced lesions, microbleeds, and subarachnoid hemorrhage on MRI. Patients in large/proximal vessel group had higher incidence of focal neurologic deficits and headache. All patients received prednisone, 2 treated with additional cyclophosphamide and another 2 with azathioprine. Relapse were more common in large/proximal vessel group.

Conclusion: PCNSV is a multifarious disease containing subdivided groups. Larger vessel type presents more aggressive course. The identification of PCNSV subgroups could help selection of adequate treatment and prediction of clinical course.

Disclosure: Nothing to disclose

Cerebrovascular diseases 4

EPR2032

Malignant left atrial appendage morphology: current classification vs H-L system

P. Parra Díaz¹, L. Salido Tahoces², A. Pardo Sanz², Á. Beltrán Corbellini¹, F. Rodríguez Jorge¹, J.L. Chico García¹, S. García Madrona¹, C. Matute Lozano¹, R. Vera Lechuga¹, A. Cruz Culebras¹, J. Masjuan¹, A. De Felipe Mimbres¹

¹Neurology, Hospital Universitario Ramón y Cajal, Madrid, Spain, ²Cardiology, Hospital Universitario Ramón y Cajal, Madrid, Spain

Background and aims: A subset of patients with atrial fibrillation suffer recurrent embolic strokes despite appropriate anticoagulant therapy. In previous studies the risk of stroke recurrence has been associated with the left atrial appendage (LAA) morphology (non-chicken wing according to the current classification), knowing those with a greater risk as malignant LAA. Recently, it has been suggested a simpler classification with 2 categories: Low-risk (LAA-L) and High-risk (LAA-H) morphologies; which could be easier to apply and could correlate better with the risk of embolic stroke.

Methods: Retrospective analysis from a registry of patients with recurrent embolic strokes despite appropriate anticoagulant therapy, in which LAA morphology had been studied with cardiac CT scan for LAA occlusion in our tertiary hospital. LAA morphology was classified according to the four current categories and H-L morphology by the same cardiologist.

Results: 26 cases were included in the analysis. We identified 22 (84.6%) chicken wing, 1 (3.8%) windsock and 3 (11.5%) cactus by the current classification system, while 15 (57.7%) were classified as LAA-H and 11 (42.3%) as LAA-L by the new system. Half of the 22 cases with chicken wing morphology were considered LAA-H by the new classification (11; 50%), whereas all non-chicken wing LAA were also classified as LAA-H morphology (4; 100%).

Conclusion: Most cases were classified as chicken wing morphology, as opposed to other previous studies. However, applying the new classification system more than half of the cases were classified as high-risk morphology, which constitutes a more expected result in our series of malignant LAA.

Disclosure: Nothing to disclose

EPR2033

Predictors of long-term mortality in spontaneous intracerebral haemorrhage survivors.

M. Pasi¹, B. Casolla², M. Kyheng³, G. Boulouis¹, G. Kuchcinski³, S. Moulin², J. Labreuche⁴, H. Hénon¹, C. Cordonnier⁵, D. Leys²

¹Lille, France, ²Stroke Unit, Lille University Hospital, Lille, France, ³Univ-Lille, Lille, France, ⁴Biostatistics, University of Lille, Lille, France, ⁵Department of Neurology, Hôpital Roger Salengro CHU, Lille, France

Background and aims: Factors associated with long-term mortality after spontaneous intracerebral haemorrhage (ICH) have been poorly investigated. Our objective was to identify predictors of long-term mortality in a prospective cohort of 30-day survivors of spontaneous ICH.

Methods: We prospectively included consecutive adults admitted between 2004 and 2009 within the 1st 24 hours of a spontaneous ICH, who survived at least 30 days. We evaluated clinical and radiological predictors of long-term mortality using univariate and multivariable Cox' proportional hazard regression models.

Results: Of 560 patients with spontaneous ICH, 304 survived more than 30 days and consented for the follow-up. During a median follow-up of 10 years (interquartile range [IQR] 8.0-10.5), 176 patients died, leading to a median survival of 6.8 (IQR 6.0-7.8) years after ICH. Age (hazard ratio [HR] per 10-year increase: 1.63; 95% confidence interval (CI): 1.42-1.87), national institutes of health stroke scale score at admission (HR per 1-point increase: 1.03; CI: 1.01-1.04), baseline ICH volume higher than 30 ml (HR: 1.62; CI: 1.10-2.38), on-going antiplatelet therapy before ICH (HR: 1.45; CI: 1.06-1.99) and pre-stroke modified Rankin scale >2 (HR: 1.72; CI: 1.20 to 2.43) were independent predictors of long-term mortality. In the subgroup of 239 patients who underwent a magnetic resonance imaging (MRI)-scan, cerebral atrophy (HR per 1-point increase: 1.48; CI: 1.11-1.97) was also independently associated with long-term mortality.

Conclusion: Characteristics related to both the ICH and pre-existing status influence long-term mortality. Cerebral atrophy was the only MRI marker independently associated with long-term mortality.

Disclosure: Nothing to disclose

EPR2034

Frailty predicts short and long-term outcomes of reperfusion treatment in acute stroke

P. Lochner¹, K. Fassbender¹, F. Roell², A. Gawlitza², A. Morotti³, A. Pezzini⁴, A. Padovani⁵, A. Pilotto⁶
¹Homburg/Saar, Germany, ²Neurology, Saarland University Medical Center, Homburg, Germany, ³Clinical and Experimental Sciences, Brescia, Brescia, Italy, ⁴Neurology, University of Brescia, Brescia, Italy, ⁵Clinical Neurology, Section for Neuromuscular Diseases and Neuropathies, Brescia, Italy, ⁶Brescia, Italy

Background and aims: Frailty is the most important short and long term predictor of disability in the elderly. The aim of the study was to evaluate whether diagnosis frailty predicts short and long-term mortality and neurological recovery in old patients who underwent reperfusion acute treatment in stroke unit

Methods: Consecutive patients were older than 65 years who underwent thrombectomy or thrombolysis in a single Stroke Unit from 2015 to 2018. Predictors of stroke outcomes were assessed including demographics, baseline NIHSS, time to needle, treatment and medical complications. Premorbid frailty was assessed with a comprehensive geriatric assessment (CGA) including functional, nutritional, cognitive, social and comorbidities status. At 3 and 12months, all-cause of death and clinical recovery (using mRS) were evaluated.

Results: 102 patients, of whom 31 underwent mechanical thrombectomy and 71 venous thrombolysis (mean age 77.5, 65- 94 years) entered the study. Frailty was diagnosed in 32 out of 70 patients and associated with older age ($p=0.001$) but no differences in baseline NIHSS score or treatment strategies. At follow-up, frail patients showed higher incidence of death at 3 (25% vs 3%, $p=0.008$) and 12 (38% vs 7%, $p=0.001$) months. Frailty was associated with worse neurological recovery at 3 month (mRS 3.4+1.8 vs 1.9+1.9, $p=0.005$) and 1 year follow-up (mRS 3.2+1.9 vs 1.9+1.9) for free survival patients.

Conclusion: Frailty is an important predictor of efficacy of acute treatment of stroke beyond classical predictors of stroke outcomes. Larger prospective studies are warranted in order to confirm our findings.

Disclosure: Nothing to disclose

EPR2035

Lymphocyte-to-monocyte ratio and C-reactive protein as potential biomarkers of cerebral venous thrombosis severity

M.J. Pinto, L. Dias, M. Carvalho
 Neurology, Hospital de São João, Porto, Portugal

Background and aims: Recent studies have shown that inflammatory biomarkers as C-reactive protein (CRP) and lymphocyte-to-monocyte ratio (LMR) are involved in thromboembolic diseases, including stroke. However, their role in cerebral venous thrombosis (CVT) is yet to be established. Our aim is to evaluate the association of LMR and CRP with clinical and imaging severity in CVT patients.

Methods: We performed a retrospective analysis of CVT cases admitted to a tertiary hospital from 2006 to 2019. We excluded cases of infection at admission, autoimmune inflammatory and haematological diseases. We evaluated the occurrence of focal neurological deficit at admission and parenchymal lesion due to CVT. Functional outcome was assessed by modified Rankin Scale (mRS) at discharge. Bivariate analyses were done with Mann Whitney U or Spearman correlation. For multivariate analyses we used binary logistic regression or linear regression.

Results: Our cohort included 78 adult patients, 74,4% female, median age of diagnosis of 43 years old. The median National Institutes of Health Stroke Scale at admission and discharge was 0. The median mRS at discharge was 1. Lower LMR levels correlated with the presence of focal neurological deficit ($p=0.016$; OR 0.663; CI 0.475-0.927) and with parenchymal lesion due to CVT ($p=0.017$, OR 0.656, IC 0.465-0.926). CRP correlated positively ($p=0.046$, OR 1.017, CI 1.000-1.035) with the occurrence of haemorrhagic lesions and with higher mRS at discharge ($p=0.037$; OR 1.027; IC 1.002-1.053).

Conclusion: In our cohort, CRP and LMR were associated with a clinical course and brain lesions suggestive of greater severity. These findings may have implication in functional outcome.

Disclosure: Nothing to disclose

EPR2036

Disability improvement in remote ischemic conditioning following acute ischemic stroke

A. Poalelungi¹, E. Turiac¹, D. Tulbă², D. Stoian³, B.O. Popescu⁴

¹Radiology, Emergency Clinical Hospital Bucharest, Bucharest, Romania, ²Neurology, Clinical Hospital Colentina, Bucharest, Romania, ³UMF Carol Davila Bucharest, Bucharest, Romania, ⁴Laboratory of Molecular Biology, "Victor Babes" National Institute of Pathology, Bucharest, Romania, Bucharest, Romania

Background and aims: Remote ischemic conditioning (RIC) is a procedure that supposedly reduces the ischemic injury of an organ. Few studies assessed the role of RIC in acute ischemic stroke (AIS)-related disability.

We aimed to evaluate the efficiency and safety of RIC in AIS patients who are ineligible for reperfusion therapy.

Methods: We performed a double-blind randomized controlled trial. The patients with AIS were assigned to receive 5 cycles of RIC twice daily during the 1st 5 days of hospitalization – an arm tourniquet was inflated either to 180mmHg (intervention group) or 30mmHg (sham group). Clinical severity and disability scales (i.e. NIHSS, mRS, Barthel, IADL, ADL), CT brain infarct volume and complications were recorded at baseline, 90 days and 180 days.

Results: 27 patients were included. Mean age was 65 years old and 60% were men. Although the outcome in terms of disability (median mRS score=0.5 vs. 1, median Barthel score=10 vs. 5, median ADL score=2.5 vs. 1) and infarct volume (median infarct volume=0.29 vs. 0.37) was better in the interventional group than in the sham group, the difference between them was not statistically significant ($p=0.9$, $p=0.7$, $p=0.7$ and $p=0.6$ respectively). RIC did not correlate with local or cerebral complications (e.g. recurrence of stroke, hemorrhagic transformation, convulsions). Prior stroke was associated with better functional outcome ($p=0.04$), suggesting the beneficial role of preconditioning in stroke.

Conclusion: In AIS, RIC is safe and well tolerated. Larger studies are required in order to prove its potential neuroprotective effect.

Disclosure: Nothing to disclose

EPR2037

Neutrophil lymphocyte ratio is associated with the severity of cerebral edema and worse functional outcome in patients with acute ischemic stroke

M. Ramalho Matias¹, D. Ferro¹, J. Neto², B. Ferraz³, A. Lima², G. Moreira⁴, E. Azevedo¹, P. Castro⁵

¹Department of Neurology, Hospital de São João - Porto, Porto, Portugal, ²Faculdade de Medicina da Universidade do Porto, Porto, Portugal, ³Depa, Faculdade de Medicina da Universidade do Porto, Porto, Portugal, ⁴Internal Medicine, São João Hospital Centre, Porto, Portugal, ⁵Neurology, São João Hospital Centre, Porto, Portugal

Background and aims: Inflammation has an important role in the pathophysiology of acute ischemic stroke. The search for biomarkers to better monitor patients with acute stroke has been of great importance and investigation. Particularly, the neutrophil lymphocyte ratio (NLR) has been associated with functional outcome. Our aim is to determine the association between NLR, cerebral edema (CED) and functional outcome, in patients with acute ischemic stroke treated with intravenous thrombolysis or/and mechanical thrombectomy.

Methods: In this retrospective study, we included all patients with acute ischemic stroke from the anterior circulation treated with intravenous thrombolysis or/and mechanical thrombectomy, between January 2017 and December 2018. We collected demographic, clinical, analytical, and imagological data on all patients. CED was classified from 0 to 3, according to severity. Functional outcome was classified using the modified Rankin scale (mRs). We estimated the odds ratios (OR) and the 95% confidence intervals, between the NLR and CED using ordinal logistic regression, and between NLR and functional outcome using binary logistic regression.

Results: 375 patients were included, median NIHSS 14 (IQR 7-19); 67% were submitted to intravenous thrombolysis and 61% to mechanical thrombectomy. In the multivariate regression model, NLR was associated with an increase of CED (OR=1.47; CI95% 1.18-1.82; $p<0.01$), and worse functional outcome (OR=0.64; CI95% 0.48-0.81; $p<0.01$).

Conclusion: In acute ischemic stroke, systemic inflammation is associated with an increased risk of severe cerebral edema and worse functional outcome. The neutrophil-to-lymphocyte ratio maybe useful in future clinical trials testing immunomodulators efficacy in acute ischemic stroke.

Disclosure: Nothing to disclose

EPR2038

Prevalence of Dehydration at acute ischemic stroke onset and correlation between stroke severity and dehydration sub-type: A prospective study from a tropical country

R. Ramesh, P. Hazeena, V. Shankar, S. Shanmugam, S. Venkatasubramaniam

Neurology, Sri Ramachandra Institute of Higher Education and Research, Chennai, India

Background and aims: Dehydration can be pathophysiologically categorised into intracellular (ID), extracellular (ED) and mixed (MD) types. Prior studies on dehydration in stroke have not taken this into consideration. The objective was determining the prevalence of dehydration at stroke onset and correlating stroke severity with dehydration subtype.

Methods: Consecutive anterior circulation ischemic stroke patients, who presented within 24 hours of symptom onset to our centre, were included. Patient’s clinical features, stroke characteristics, and severity (NIHSS score) were recorded. Patients with renal and pulmonary diseases, uncontrolled diabetes, on diuretics, and intravenous fluids were excluded. Dehydration subtypes were categorised and their surrogate markers, including Urine osmolarity/plasma osmolarity ratio (>1.5), BUN creatinine ratio (>15,) urine specific gravity (>1.020), apart from U.sodium, Serum chloride, sodium, uric acid levels, and IVC collapsibility were recorded.

Results: 177 ischemic stroke admissions were surveyed, of which 72 met the inclusion criteria. 65% were dehydrated, of which 33.3% had ID, 30 % had MD and interestingly 36 % had positive markers for both MD and ID (ED not separately categorised as no defined surrogate marker). Average NIHSS for hydrated, ID, MD and MD+ID groups were 4.1, 5.9, 6.5 and 9 respectively. Statistically significant correlation was found between presence of dehydration, especially a multitype dehydration and severity of stroke at onset (p<0.005).

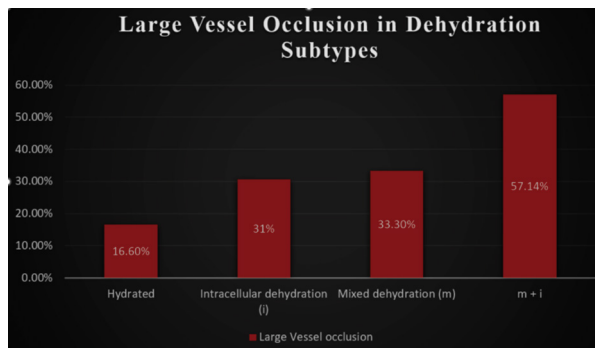

Large vessel occlusion percentages in various Dehydration subtypes

Conclusion: Nearly 2/3rds of stroke patients were dehydrated at onset. There was significant correlation between the presence of multi-type dehydration and a more severe stroke. Our study emphasizes that, accumulated Dehydration, as a precipitous trigger for ischemic incidents, needs scrutiny.

Disclosure: Nothing to disclose

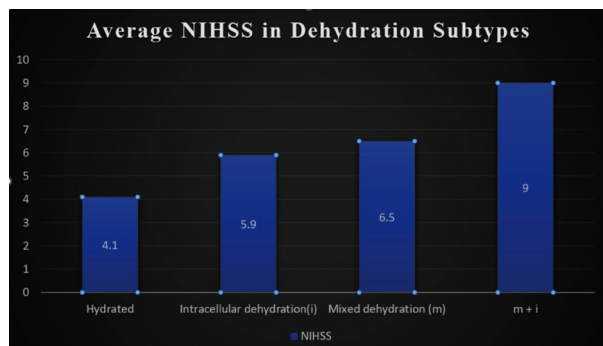

Average NIHSS in Dehydration subtypes

EPR2039

CHA2DS2-VASc score in predicting stroke severity, mortality and worse prognosis in a cohort of 566 patients, with or without atrial fibrillation, admitted for ischaemic stroke

N. Rifino¹, C. Scaccabarozzi², V. Mantero², A. Aliprandi², D. Sangalli², G. Costantino², M.G. Filizzolo³, C. Ferrarese¹, A. Salmaggi²

¹Neurology, University of Milano-Bicocca, Monza, Italy,

²Department of Neurology, Lecco Hospital, Lecco, Italy,

³Department of Neuroradiology, Lecco Hospital, Lecco, Italy

Background and aims: The CHA2DS2-VASc score is recommended by the International Guidelines. Its predictive abilities in stroke and thromboembolic risks stratification of atrial fibrillation(AF) patients have largely been demonstrated. However, its use as predictor of stroke severity and as prognostic factor is controversial, both in AF and non-AF-patients. Our aim is to investigate if the CHA2DS2-VASc would predict ischaemic stroke severity and prognosis in patients with or without AF.

Methods: We performed a retrospective study including 566 patients (AF:26%; non-AF:74%), admitted with ischaemic stroke between 2012 and 2013. We divided our population into 3 groups, depending on their CHA2DS2-VASc (low-L-,middle-M- and high-risk-H-patients). We calculated their NIHSS at admission and their modified-Rankin scale score (mRS) before admission, at discharge and after 6 months (excluding those who died during the hospitalization-7.9%). Finally, for each group, we analysed if any difference between AF and non-AF-patients could be detected.

Results: Patients with higher CHA2DS2-VASc had a greater risk to develop a stroke with higher NIHSS (P-value<0.0001) (fig.1) and a higher mortality rate (L-2.9%;M-9.9%;H-8%);both in AF and non-AF-patients. However, AF-patients had a worse NIHSS compared to the non-AF-patients. They also had increased mortality in the low and middle-risk-group.

The rate of patients with a worse mRS after 6 months increased over the groups(7%-L, 18.5%-M and 29%-H-risk-group) (fig.2). The same is observed both for AF and non-AF-patients(fig.3).

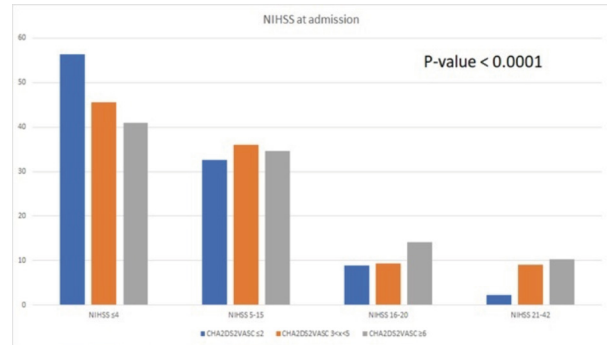

The patients have been divided into 3 different groups, depending on their CHA2DS2-VASc score (low-blue; middle-orange; high risk patients-grey column) and into 4 groups depending on their NIHSS score. Thus, the correlation between the pre-admission CHA2DS2-VASc score and the NIHSS has been detected

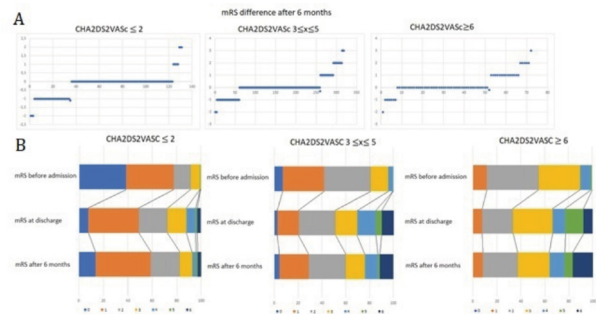

A. Difference between mRS score after 6 months and at discharge for each CHA2DS2-VASc score group. B. Shift analysis of the mRS score in each CHA2DS2-VASc score group

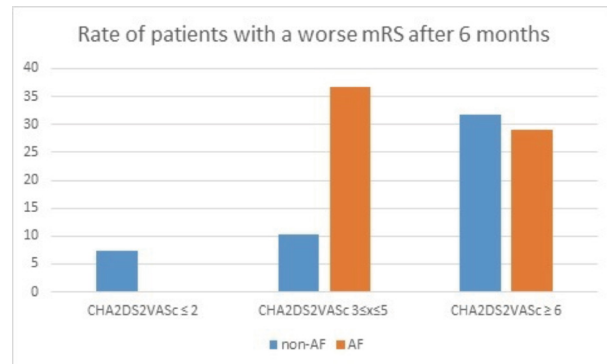

Correlation between worse mRS score at 6 months and presence or absence of comorbid atrial fibrillation in each CHA2DS2-VASc score group

Conclusion: Our data seem to support the use of the CHA2DS2-VASc-score not only as simple tool for cerebrovascular risk but also as a predictor of stroke severity, mortality and worse recovery in AF and, interestingly, also in non-AF-patients.

Disclosure: Nothing to disclose

EPR2040

Anticoagulation treatment in the acute phase of cardioembolic stroke: a retrospective study

R. Rigual, G. Torres Iglesias,
C. Lastras Fernández-Escandón, R. Gutierrez Zuñiga,
J. Rodríguez Pardo de Donlenbún, G. Ruiz Ares,
E. De Celis, S. Pastor Yvorra, M. Alonso de Leciñana,
B. Fuentes, E. Diez Tejedor
Neurology, Hospital Universitario La Paz, Madrid, Spain

Background and aims: Although anticoagulation treatment for cardioembolic stroke prevention is recommended, there is no consensus for continuation or disruption anticoagulation in the stroke acute phase. Our aim is to describe treatment variations and compare clinical outcomes in these patients.

Methods: A pilot, retrospective, observational, cohort study of adult patients admitted in a Stroke Center between January 2014 and December 2018 with diagnosis of acute cardioembolic ischemic stroke receiving anticoagulation at admission. Patients who received intravenous thrombolysis were excluded. According to continuation or discontinuation anticoagulation by treating neurologist at admission, we compared safety and clinical outcomes at discharge and at 90 days.

Results: We identified 177 patients, anticoagulation was continued in 106 (59 %) patients. These patients had lower National Institutes of Health Stroke Scale (NIHSS) scores (median 4 vs 14, $P < 0.001$), lower hemorrhagic transformation in neuroimaging (14.8% versus 33%, $P = 0.025$) but similar thrombotic and major bleeding events at discharge. We found lower mortality and better functional outcome at 90 days in patients in whom anticoagulation was continued (mortality 6% versus 34%, $P = 0.01$ and modified Rankin Scale score of 0–2, 54.2% versus 73.7%, $P = 0.031$), however the statistical difference disappears after adjusting by NIHSS at admission. Among patients with a severe stroke ($\text{NIHSS} > 15$) there was no difference in clinical outcome or mortality between

Conclusion: Our pilot study suggests the continuation of anticoagulation in early phase of cardioembolic stroke is safe, even in severe stroke, and it was associated with better outcomes. Further prospective studies are needed to confirm these findings.

Disclosure: Nothing to disclose

EPR2041

Cancelled

EPR2042

Causes and rates of switching across direct oral anticoagulants: a real-life setting prospective study, systematic review and meta-analysis

M. Romoli¹, G. Marchetti², F. Bernardini², S. Urbinati²

¹Neurology, Rimini "Infermi" Hospital, Rimini, Italy,

²Cardiology, Bellaria Hospital, Bologna, Bologna, Italy

Background and aims: Crossover between direct oral anticoagulants (DOACs) has been underinvestigated, but happens frequently in clinical practice. The purpose of this study was to evaluate causes, rates and outcomes of DOAC-to-DOAC switch.

Methods: Patients receiving first DOAC prescription at the Anticoagulation-Center, Cardiology-Dept, Bologna-Bellaria Hospital in 2017-2018 were consecutively included and prospectively followed-up. DOAC-to-DOAC switch was the main outcome; causes of switch (cardiovascular-CV-events and non-CV drug-related adverse events), had direct biannual assessment before and after switch. We systematically reviewed (OSF-registered protocol) published studies reporting DOAC-to-DOAC switch, and determined by meta-analysis the pooled odds ratio (OR) for switch depending on index DOAC prescribed.

Results: Among 300 patients enrolled (mean age=79.3, mean follow-up=1.5 years), with no difference in CV risk factors depending on index DOAC, 13% underwent DOAC-to-DOAC switch, minor bleeding and non-CV adverse events being the most frequent causes. Dabigatran carried a 3-fold increase in risk of switch compared to other DOACs. Factors leading to switch resolved in 87% of cases afterwards. Annual rates of CV/non-CV events did not differ before and after switch. Pooling our data with those from 5 retrospective claim-based studies (n=259308), apixaban had consistently lower risk of DOAC-to-DOAC switch compared to dabigatran [OR=0.29 (0.25-0.34)] or rivaroxaban [OR=0.58 (0.50-0.67)], the former carrying a higher risk than the latter [OR=0.2.35 (1.93-2.86)].

Conclusion: DOAC-to-DOAC switch happens in 9%/year, and seems not to impact rates of CV events after switch. Dabigatran might carry a higher risk of DOAC-to-DOAC switch. Further studies are needed to confirm long-term safety and effectiveness of switching paradigm.

Disclosure: Nothing to disclose

Cognitive neurology/neuropsychology 2

EPR2043

Motor imagery by the hand laterality task in Wilson's disease patients

N. De Lucia, A. Roca, G.R. Palmieri, L. Ambrosio, G. De Michele, A. De Rosa
Department of Neurosciences, Reproductive and Odontostomatological Sciences, University of Naples Federico II, Naples, Italy

Introduction: Motor Imagery (MI) refers to mental simulation process in which we imagine to perform an action without actually moving any muscles of body. MI impairments have been reported in several neurological disorders, but it has never been investigated in Wilson's disease (WD).

Methods: To explore MI in WD, we enrolled 19 WD patients attending the Movement Disorders Unit of the University of Naples and 15 healthy controls (HC) of similar sex, age and education. All participants completed the Global Assessment Scale (GAS), constructional, frontal and memory neuropsychological tests and scales for apathy and depression, and MI tasks (i.e., hand laterality judgement and letter rotation). In both tasks, participants had to judge whether a visual stimulus (hand or capital letter) presented in different angular orientations (0°, 90°, 180°, 270°) portrays a left or right laterality (left-right hand or canonical-mirror letter).

Results: Independent-sample t-tests showed that WD achieved significant lower scores on attentional ($p=0.02$) and Raven's matrices ($p=0.01$) tests, compared to HC. ANOVAs on correct response (accuracy) and reaction times (RTs) showed significant effects of orientation [$F(3,96)=7.611$, $p<.001$, $F(3,96)=4.145$, $p<.001$] and orientation-by-laterality, [$F(3,96)=3.199$, $p=0.02$, $F(3,96)=12.064$, $p<0.001$], with responses less accurate and RTs slower in judging left hand at 180° compared to the others orientations (all $p<0.05$), in WD.

Conclusion: Our findings demonstrate a specific alteration of MI skills in WD, thus supporting the simulation view according to which MI would be crucial in understanding intention and actions of others.

Disclosure: Nothing to disclose

EPR2044

Emotional Memory in Multiple Sclerosis Patients

C. Lafi¹, C. Bakirtzis², E. Konstantinopoulou¹, M. Dimitriou², R. Katsavou¹, M. Kotouba¹, P. Ioannidis², V. Giantzi², T. Afrantou², N. Grigoriadis², E. Aretouli¹
¹*School of Psychology, Laboratory of Cognitive Neuroscience, Aristotle University of Thessaloniki, Greece, Thessaloniki, Greece, ²2nd Department of Neurology, Aristotle University of Thessaloniki, AHEPA University Hospital of Thessaloniki, Thessaloniki, Greece*

Background and aims: Emotional memory has been poorly studied in Multiple Sclerosis (MS). This study investigated the ability of MS patients to recognize emotionally charged material and compared this ability with their performance in verbal and visual episodic memory testing.

Methods: 30 MS patients and 30 healthy individuals matched for age, gender and education were included in the study. Participants underwent 2 memory tests (Greek Verbal Learning Test-II, Brief Visuospatial Memory Test-Revised) that assessed verbal and visuospatial learning and an experimental task (Emotional Memory Test, EMT). Addenbrooke's Cognitive Examination – Revised (ACE-R) and Depression Anxiety Stress Scale-21 were administered as measures of overall cognitive ability and presence of psychiatric symptoms respectively. Repeated measures ANOVA was conducted to investigate memory performance of MS patients and stepwise linear regression to clarify the contributing factors affecting EMT scores.

Results: MS patients performed poorly on all memory tests as compared to healthy participants (GVLII-II: $p=0.029$, BVMT-R: $p=0.013$, Emotional Memory Test- Word Recognition: $p=0.018$, Emotional Memory Test – Picture Recognition: $p=0.007$). Patients' performance on the verbal condition of the Emotional Memory Test was predicted by their overall cognitive ability [$R^2=0.363$, $F(2,24)=6.84$, $p=0.004$ ACE-R: $\beta=0.368$, $p=0.037$] but no variable predicted the particularly low performance observed in the visual condition of the test.

Conclusion: Findings support the presence of a specific deficit in visual emotional memory of MS patients, which is not related to clinical characteristics and performance in memory testing.

Disclosure: Nothing to disclose

EPR2045

Nonverbal cognitive deficits in left-hemisphere aphasic patients: relationship with sites of lesion and linguistic measures

A. Economou¹, C. Routsis¹, S. Papageorgiou², S. Varlokosta³

¹Department of Psychology, National and Kapodistrian University of Athens, Athens, Greece, ²Second Department of Neurology, "Attikon" University General Hospital, National and Kapodistrian University of Athens, Athens, Greece, ³Department of Linguistics, School of Philology, National and Kapodistrian University of Athens, Athens, Greece

Background and aims: Studies on the relationship between nonverbal and verbal measures in aphasia have yielded contradictory findings. This study examines the relationship between these measures and site of lesion in aphasic stroke patients.

Methods: Participants: 27 aphasic stroke patients (mean age 59.96±10.35) and 35 controls (65.80±9.42) were administered a neuropsychological battery. Patients scoring below a nonverbal cognitive screening cutoff were excluded. Patient lesion areas were measured from MRI scans. Measures and analyses: Number of lesion areas (Table 1), Modified Rankin Scale (Rankin), Barthel Index (Barthel), verbal and nonverbal measures (Table 2) are shown per patient. Patients scoring below 1.5 SD of the mean of controls in nonverbal domains were compared with those scoring above. Performance in verbal and nonverbal domains was correlated with lesion areas and the two disability measures.

Partic code	L.ACA lesions	L.PCA lesions	L.MCA lesions	L. subcort	L.BG	L.int caps	L. ant chor art	L. total	R.ACA lesions	R.PCA lesions	R.MCA lesions	R. subcort	R.BG	R. total
100	6	1	1	1	1	1	1	9						0
110	1	10	1	1	1	1	1	14			1			1
121	4	1	1	1	1	1	1	6				1		3
301	3					1		4			3			3
302	2	4	1					7	3		4			7
303	9							9						0
304	1	9	1				1	12						0
601	3	1	1	1	1	1	1	7						0
604	8	1	1	1	1	1	1	12						0
605	6	1	1	1	1	1	1	9						0
801	6	1						7		3	1	1	1	5
802	3	1	1					5		1				1
904	1	5	1	1	1	1	1	9						0
905	1	6	1					8			1	1	1	2
906	2	10	1	1	1	1	1	16		1	2	1	1	4
907	1	5	1					7			2	1	3	3
908		6	1					7						0
910	4	7	1					12			3			3
912	3	1	1	1	1			6						0
913	1	10					1	12	1		2			3
914	1	8	1	1	1	1	1	13						0
915		7	1	1	1	1	1	11						0
916	2	4	1	1	1	1	1	10						0
917	1	2	1					5						0
918	2	9	1	1	1	1	1	14						0
920		7	1	1	1	1	1	9				1		1
922	1	2	7	1	1	1	1	14						0

Partic. code: participant code; L: left hemisphere; R: right hemisphere; ACA: anterior cerebral artery; PCA: posterior cerebral artery; MCA: middle cerebral artery; subcort: subcortical; BG: basal ganglia; int caps: internal capsule; ant chor art: anterior choroidal artery. Note: no R internal capsule and R anterior choroidal artery lesions were found in any of the participants.

Table 1. Number of lesions in each vascular territory per stroke patient

110	B	4	>5	<3	<3	3	0	2	1	7	00	14	3	0	9
121	B	3	90	<3	<3	0	2	0	0	15	64	12	6	9	34
301	C	1	95	>5	>5	13	5	6	7	13	45	12	5	4	13
302	A	1	100	>5	>5	9	3	7	7	7	36	10	2	4	11
303	NF	3	3	3.5	3.5	7	1	3	2	10	32	5	7	6	5
304	B	4	55	<3	<3	0	0	0	0	6	58	12	4	7	20
601	G	4	55	<3	<3	0	0	0	2	5	29	6	4	3	8
604	B	4	70	<3	<3	0	0	0	4	4	43	10	5	6	13
605	A,C	4	60	>5	>5	6	1	3	5	12	65	14	5	5	26
801	G	2	95	<3	<3	6	0	0	4	12	54	13	6	6	8
802	B	1	95	<3	<3	9	6	10	5	12	56	14	8	7	38
904	TM	3	75	3.5	3.5	0	3	0	1	11	7	43	9	4	7
905	NF	3	50	<3	3.5	10	3	3	4	14	34	9	5	5	16
906	NF	4	40	3.5	3.5	12	6	4	9	9	54	11	7	8	13
907	A, Dys	4	65	<3	>5	12	15	7	13	12	69	11	8	7	17
908	B	3	55	3.5	3.5	0	3	2	3	10	70	10	7	2	14
910	B	3	60	<3	<3	0	0	0	4	9	56	13	5	7	9
912	A, Ag	2	85	>5	>5	8	0	2	7	5	81	10	3	2	7
913	A	1	95	>5	>5	13	18	10	10	8	54	10	5	2	14
914	G	3	90	<3	<3	0	0	0	0	16	57	14	7	6	33
915	B	3	95	<3	<3	3	2	3	2	13	67	12	7	7	16
916	A	1	100	>5	>5	14	16	9	17	18	68	14	7	8	27
917	F	4	65	3.5	>5	9	2	1	4	12	48	12	4	5	11
918	B	4	55	<3	<3	1	0	1	1	9	39	11	6	7	7
920	A	0	100	>5	>5	13	12	11	11	18	70	12	7	7	28
922	G	4	70	<3	<3	2	0	0	1	3	37	5	1	2	3
CN	-	-	-	-	-	13.91	35.23	17.40	14.03	13.83	64.97	13.20	7.00	7.37	22.91
						(±0.28)	(±9.58)	(±3.11)	(±2.53)	(±3.16)	(±7.44)	(±1.08)	(±1.57)	(±1.90)	(±13.25)

Aphasia type: B = Broca's, C = Conduction, A = Anomic, G = Global, TM = Transcortical Motor, NF = Nonfluent unspecified, F = Fluent unspecified, Ag =agrammatic, Dys = dysarthric, Artic agilty: Articulatory agility, <3 = severe impairment, 3.5 moderate impairment, >5 = mild-no impairment; Phon fluency: phonological fluency; Animal: animals (semantic fluency); Vis mem immed: Visuospatial memory immediate; Vis mem del: Visuospatial memory delayed; Symp point: symbol pointing task (a span task); Pict point: picture pointing task; GAMA: General Ability Measure for Adults. Note: Tests in italics are nonverbal; in bold are test results <1.5 SD from the mean of the controls.

Table 2. Disability measures and test performance in verbal and nonverbal domains per stroke patient

Results: Patients were impaired in most verbal areas compared to controls, as expected. 12 patients scored within the normal range in the 6 nonverbal measures employed (Table 2), but did not differ from those scoring below in number of left or right hemisphere lesions, nor in verbal task performance. Left hemisphere lesions correlated with few verbal tasks (none after correction). The Rankin correlated negatively with all verbal tests and 1 nonverbal, and the Barthel positively with 1 verbal test and 2 nonverbal (Table 3).

	Rankin	Barthel	Artic agility	Phrase length	Mental Control	Phon fluency	Animal	Digit span	Spatial span	V mem immed	V mem del	Symp point	Pict point	GAMA
L.ACA	.03	-.15	.09	.10	.01	-.04	-.08	.11	-.36	-.16	-.07	-.29	-.09	-.38*
L.PCA	.13	-.02	-.01	.03	.00	-.03	-.18	.10	-.09	-.11	-.09	-.44*	-.19	-.08
L.MCA	.27	-.36	-.29	-.30	-.20	.02	-.08	-.25	-.12	.08	-.02	-.20	-.29	-.11
L.subcort	.30	-.09	-.39*	-.27	-.37	-.30	-.29	-.10	.01	.27	.27	.03	.26	.20
L.BG	.20	-.10	-.14	-.28	-.19	-.19	-.06	-.15	-.12	.07	.15	.09	.12	.14
L.int caps	.16	-.15	-.22	-.22	-.30	-.12	-.20	-.03	.03	.04	-.11	.08	.18	.16
L. ant chor art	.25	-.09	.10	.05	-.03	.07	-.09	-.00	-.13	-.02	-.02	-.21	-.08	-.07
L. lesions	.39*	-.35	-.27	-.30	-.28	-.07	-.21	-.18	-.27	.03	-.02	-.03	.18	-.18
R.ACA	-.35	-.31	.37	.28	.21	.15	.30	.15	-.20	-.26	-.11	-.38*	-.25	-.11
R.PCA	.20	-.35	.06	.22	.24	.09	.30	.18	-.07	.01	-.01	.16	.24	-.06
R.MCA	-.30	-.20	.16	.19	.34	.21	.23	.25	-.09	-.09	.16	-.11	-.03	-.22
R.subcort	-.03	-.04	-.15	.12	.32	.28	.11	.21	.37	.19	.05	.29	.38*	.19
R.BG	-.05	-.33	-.25	-.14	.12	-.11	-.15	-.07	.18	-.21	-.01	-.00	-.00	-.12
R.lesions	-.31	-.18	.16	.25	.41*	.24	.26	.27	-.02	-.13	.08	-.12	.01	-.16
total														
Rankin			-.58***	-.36	-.57**	-.49**	-.76***	-.52**	-.48*	-.19	-.27	-.23	-.01	-.36
Barthel			.36	.14	.31	.34	.52**	.34	.44*	.31	.37	.14	.07	.44*

Artic agility: Articulatory agility (BDAE); Phrase length: Phrase length (BDAE); Mental Control: Mental Control (BDAE); Phon fluency: phonological fluency; Animal: animals (semantic fluency); Vis mem immed: Visuospatial memory immediate (trials 1-5); Vis mem del: Visuospatial memory delayed; Symp point: symbol pointing task (a span task); Pict point: picture pointing task (a span task); GAMA: General Ability Measure for Adults. * p < 0.05, ** p < 0.01, *** p < 0.001. Note: Tests in italics are nonverbal; in bold are correlations that remain significant after Bonferroni correction.

Table 3. Correlations of verbal, nonverbal and disability measures with number of regions in each vascular territory

Conclusion: Nonverbal cognitive deficits were frequent in the aphasic patients but were unrelated to number of lesions in left or right hemisphere or to verbal task performance. The Rankin and Barthel are sensitive to different verbal and nonverbal domains.

Disclosure: The present study is funded by the European Union (European Social Fund – ESF) and Greek national funds through the Operational Programme “Education and Lifelong Learning” of the National Strategic Reference Framework (NSRF) – Research Funding Programme: THALES – UOA – “Levels of impairment in Greek aphasia: relationship with processing deficits, brain region, and therapeutic implications.”

EPR2046

Non-prescribed usage of psychostimulant drugs by medical students

S. Ertuğrul¹, M. Nabantoglu², D. Necioglu Orken²
¹Neurology Intern, Demiroglu Bilim University, Istanbul, Turkey, ²Neurology, Demiroglu Bilim University, Istanbul, Turkey

Background and aims: Students feel pressure to succeed in the highly competitive medical school environment and misuse stimulant drugs in order to enhance their focus and endurance. The aim of this study is to investigate the frequency and the side effects of stimulant usage.

Methods: A total of 326 people participated to the study. 32 students who were previously diagnosed with ADHD were excluded from analysis. The control group consisted of 93 1st grade and the study group consisted of 101 4th, 5th and 6th grade students. An online survey was used to investigate the habits of stimulant drugs usage, side effects and grade point average of the students.

Results: 16.1% of study group versus 6.8% of controls was using drugs. Although stimulant usage was higher in the study group, it was not statistically significant ($p=0.06$). Among the study group 64% were using methylphenidate, 14% modafinil and 21% were using both. 75% of the study group stated that they experienced various side effects. According to their evaluations, 79% of the students had increased performance. But grade point averages were not differ between stimulant user and not users ($GPA_{non-users}=2.91\pm 0.8$ and $GPA_{users}=3.07\pm 0.8$, $p=0.85$).

Conclusion: Our study has shown that stimulant usage increases in the course of medical education. However stimulants don't have any positive effects on GPA. We advocate more research in this area to expose the extent of the problem and begin to explore potential solutions for study habits and lifestyle choices.

Disclosure: Nothing to disclose

EPR2047

Lower motor neuron signs in the clinical spectrum of Creutzfeldt-Jakob disease: a case report

F. Serrazina, M. Fernandes, A. Caetano
 Neurology Department, Hospital Egas Moniz, Centro Hospitalar de Lisboa Ocidental, Lisbon, Portugal

Background: Creutzfeldt-Jakob disease (CJD) is a neurodegenerative disease characterized by rapidly progressive dementia. The clinical signs of CJD mainly reflect involvement of the central nervous system, although lower motor neuron involvement is rarely reported.

Methods: Case Report

Results: A 69-year-old man presented with a subacute cerebellar axial ataxia and important cognitive decline, rapidly progressing over 3 weeks. He scored 25/30 on Mini-Mental State Examination. Neurological examination revealed generalized hyperreflexia, a left pyramidal syndrome and ataxic gait, rendering him unable to walk unassisted. 2 months later, amyotrophy of the lower limbs with fasciculations were present. By this time, he also presented generalized myoclonic jerks and rapidly progressed to akinetic mutism 3 months after admission. Brain MRI diffusion-weighted imaging showed left caudate head, putamen and thalamus hyperintensity; CSF examination was positive for 14.3.3 protein; electroencephalogram denoted periodic complexes; and needle electromyography showed diffuse neurogenic potentials with spontaneous activity, suggestive of active denervation. Genetic studies found no mutations in prion gene PRNP and codon 129 polymorphisms analysis showed valine/valine (VV) homozygosity. Post-mortem brain histopathology revealed extensive vacuolization in the neocortex and basal ganglia and evaluation of spinal cord (L2-S1 segment) showed marked atrophy and neuronal loss of anterior horn cells, suggestive of motor neuron disease related to sporadic CJD.

Conclusion: Although rare, lower motor neuron signs can be part of the clinical spectrum of sporadic CJD, with histopathological correlation in neuropathology studies.

Disclosure: Nothing to disclose

EPR2048

Withdrawn

EPR2049

Spatial navigation in early multiple sclerosis

J. Lacz^ó, E. Nema, A. Kalina, T. Nikolai, M. Vyhⁿálek, E. Meluzinova

Department of Neurology, Charles University, 2nd Faculty of Medicine, Motol University Hospital, Prague, Czech Republic

Background and aims: Cognitive deficits with predominant slowing of information processing speed and impairment of episodic memory are common in early multiple sclerosis (MS). Spatial navigation changes and their associations with brain pathology have not been studied in MS. The aim was to characterize the profile of spatial navigation changes in 2 main navigational strategies (egocentric and allocentric) and their associations with demyelinating and neurodegenerative changes in early MS. **Methods:** Participants with early MS after the first clinical event (n=51) and age-, gender- and education-matched controls (n=42) underwent spatial navigation testing in a real-space human analogue of the Morris water maze, neuropsychological assessment, and MRI brain scan with voxel-based morphometry and volumetric analyses.

Results: The early MS group had lower performance in all spatial navigation tasks ($p \leq 0.038$). Based on the applied criteria, lower performance was present in 22–41% and 14–33% of the participants with early MS. The early MS group with less accurate spatial navigation had lower performance in various neuropsychological tests ($p \leq 0.039$). Smaller volume of the left nucleus accumbens ($\beta = -0.36$; $p = 0.011$) and larger lesion load volume in the cortical, subcortical and cerebellar regions ($\beta \geq 0.29$; $p \leq 0.032$) were associated with less accurate allocentric navigation performance.

Conclusion: Lower spatial navigation performance is present in 14–41% of the participants with early MS, who also have lower performance in other cognitive functions. Lesion load in specific brain regions is associated with allocentric spatial navigation changes in early MS.

Disclosure: This study was supported by the Grant Agency of the Charles University, Prague Grant No. 546317; Ministry of Health, Czech Republic – conceptual development of research organization, University Hospital Motol, Prague, Czech Republic Grant No. 00064203; and Institutional Support of Excellence 2. LF UK Grant No. 699012.

EPR2050

Memory impairment in FTD patients with pathogenic mutations

M. Lima¹, I. Baldeiras², M.R. Almeida³, M. Pereira¹, D. Duro⁴, I. Gomes⁵, I. Santana¹

¹Neurology Department, Centro Hospitalar e Universitário de Coimbra, Coimbra, Portugal, ²Laboratório de Neuroquímica, Centro Hospitalar e Universitário de Coimbra, Coimbra, Portugal, ³Genetics, CNC, Coimbra, Portugal, ⁴Neurology, Centro Hospitalar e Universitário de Coimbra, Coimbra, Portugal, ⁵Coimbra, Portugal

Background and aims: A relative sparing of episodic memory compared to semantic/working memory is accepted in FTD patients, but this particular cognitive profile is more controversial in genetic-forms. Our aim was to characterize memory-related profiles of GRN and C9orf72 patients, the most prevalent genetic-forms in Portugal.

Methods: 31 FTD patients, including 18 GRN and 13 C9orf72 mutation carriers, were assessed with a neuropsychological comprehensive battery including Wechsler Memory Scale. Individual raw scores were converted into Z-scores. Differences between groups in working, semantic and verbal/visual episodic memory were examined and group performances in the different memory tasks were further correlated with data from CSF-biomarkers (A β 42, tau, p-tau and NfL).

Results: GRN patients had a mean age-of-onset of 56.39 (SD=5.69) years and the C9orf72 group tend to be older (M=59.45, SD=7.04). Of the total sample 71.4% (22/31), 72% (18/25) and 78% (25/31) had respectively working memory, episodic memory and semantic/autobiographic memory deficits, usually as a compound deficit. Considering episodic memory 61% (16/27) had verbal memory deficits, 49% (13/27) had visual memory deficits and 87% (18/27) had a mixed deficit. Group comparisons through non-parametric Mann-Whitney U test, showed that C9orf72-patients performed better in working memory and episodic memory/learning ($p < 0.05$). Concerning differences in CSF-biomarkers between groups, only higher levels of p-tau in C9orf72-patients were found ($p = 0.007$). A significant correlation between p-tau/tau ratio and visual memory was found in GRN-patients ($r = 0.711$, $p = 0.001$).

Conclusion: This study shows that there is a broad profile of memory impairment in genetic-forms of FTD, including episodic memory, which correlates with biomarkers of neurodegeneration.

Disclosure: Nothing to disclose

EPR2051

Effect of subthalamic nucleus deep brain stimulation on emotional prosody processing in Parkinson's disease: a review and meta-analysis

S. Kalampokini, E.E. Lyros, P. Lochner, K. Fassbender, M. Unger
Neurology, Saarland University Medical Center, Homburg, Germany

Background and aims: Deep brain stimulation (DBS) of subthalamic nucleus (STN) leads to substantial motor improvement of Parkinson's disease (PD). Nevertheless, it is followed by behavioral or emotional changes. Aim of this study was to examine whether STN DBS induces changes in emotional processing (perception, recognition, expression) of vocal stimuli.

Methods: We conducted a literature search in Medline and Web of science between 2000 and 2019 using the keywords "prosody", "emotion", "deep brain stimulation", "Parkinson". We included studies assessing prosody processing of the basic emotions (happiness, sadness, fear anger, surprise, disgust and neutral) in PD patients after STN DBS. Additionally, we conducted a meta-analysis including 5 studies assessing emotional prosody recognition in the same or matched PD patients before and after STN DBS (both on medication, ON stimulation).

Results: Most studies showed no prosody recognition impairment after STN DBS (analysis comparing matched PD patients: random model Hedges' $g=-0.038$, $p=0.852$, $I^2=0$, $P=0.665$; analysis comparing the same PD patients pre- and post-operative: random model Hedges' $g=-0.087$, $p=0.577$, $I^2=0$, $P=0.354$). Moreover, there was no difference in prosody recognition ON or OFF stimulation. Nevertheless, patients perceived emotions more strongly after STN DBS. Concerning prosody emotion expression, fear was less well recognized when expressed postoperative.

Conclusion: Our results suggest that although STN DBS can induce changes in emotional prosody processing, there seems to be no prosody recognition impairment post-operative. Future studies with larger patient samples using standardized testing are needed, in order to derive definite conclusions about the effect of STN DBS on emotional prosody processing.

Disclosure: Nothing to disclose

EPR2052

Neuropsychological and neurological signs associated with the phenomenon of an alien hand in stroke

K. Mashkovich¹, V. Grigoryeva¹, V. Nesterova²
¹*Department of Nervous System Diseases, Privolzhsky Research Medical University, Nizhny Novgorod, Russian Federation*, ²*Stroke center, Nizhny Novgorod Regional Hospital named after N.A. Semashko, Nizhny Novgorod, Russian Federation*

Introduction: Alien hand syndrome (AHS) is a rare neurological disorder characterized by involuntary movements of the hand in association with the feeling that it acts on its own will. Typical combinations of an alien hand with other neurological and neuropsychological syndromes are underexplored. The aim of the work was to analyze the relationship between AHS and neurological/neuropsychological signs in patients with acute ischemic stroke (IS).

Methods: 9 acute stroke patients with AHS (mean age of 64.2 ± 4.7 years, range 42-86) were identified in the stroke center over a 10 year period. Neurological, neuropsychological and neuroimaging data were evaluated.

Results: 7 patients had right and 2 patients had left hemisphere IS. Foci of lesions had different topography but all patients ($n=9$) had at least partial involvement of a parietal lobe. Other involved structures included the frontal ($n=3$), temporal ($n=2$) and occipital ($n=3$) lobes, basal ganglia ($n=6$), corpus callosum ($n=1$). AHS was the earliest manifestation of IS and caused fright. It developed along with the feeling of coldness, mild hypoesthesia for pain and impairment of stereognosis and graphesthesia in the same hand. Ideomotor apraxia in both hands was present in all cases while constructional apraxia was identified in the majority ($n=6$), but still not in every patient. Executive dysfunction was not a hallmark of these patients and was found in only 2 cases.

Conclusion: Alien hand syndrome in IS patients is strongly associated with parietal lesions, impairment of elementary and discriminative sensation in the same hand as well as with ideomotor apraxia.

Disclosure: Nothing to disclose

Epilepsy 2

EPR2053

Validation of SeLECT score in prediction of late seizures in ischaemic stroke patients

P. Jansky¹, T. Růžičková¹, A. Olšerová¹, L. Šfovičková¹, J. Paulasova-Schwabova¹, V. Šulc¹, H. Magerova¹, I. Sarbochova¹, J. Otáhal², P. Jiruška², P. Marusic¹, M.S. Vosko³, J. Reichl⁴, M. Vosko⁴, A. Tomek¹

¹Neurology, ^{2nd} Medical Faculty of Charles University and Motol University Hospital, Prague, Czech Republic,

³Institute of Physiology CAS, Prague, Czech Republic,

⁴Technical University of Munich, School of Medicine, Munich, Germany, ⁵Neurology, Kepler Universitätsklinikum, Med Campus III, Linz, Austria

Background and aims: Ischaemic stroke is an important cause of structural epilepsy in adults. The SeLECT score is a major prediction model for late post-stroke seizures. The aim of our study is to verify the ability of the SeLECT score and its parameters (severity of the stroke, large-artery atherosclerosis, early seizures, cortical involvement, the involvement of the middle cerebral artery territory) to predict late seizures in ischaemic stroke patients.

Methods: Retrospective analysis of consecutive supratentorial ischaemic stroke survivors with a negative history of epilepsy admitted to 2 major comprehensive stroke centers in the Czech Republic and Austria in a year period (2015). The follow-up information was collected from available medical documentation, structured telephone questionnaire, and patients visits. The median follow-up period was 3.3 years. To assess the risk of late seizures, Cox proportional hazards regression analysis was performed.

Results: 315 patients were included (59% men, average age 69 years, median NIHSS 4, 29.2% received intravenous thrombolysis, in 6.3% mechanical thrombectomy was done). Late seizures occurred in 24 patients (7.6%). The SeLECT score as continuous variable showed hazard ratio 1.576 per point (95% CI 1.229–2.020; $p < 0.001$) with AUC 0.69 (95% CI 0.586–0.794). The hazard ratio of large-artery atherosclerosis was 2.210 (95% CI 0.989–4.942, $p = 0.053$) and cortical involvement of the ischaemic lesion 3.807 (95% CI 1.576–9.195, $p = 0.003$). The rest of the SeLECT score parameters performed insignificantly.

Conclusion: The SeLECT score was a significant predictor of late seizures in ischaemic stroke patients of our cohort. Cortical involvement had the highest hazard ratio of SeLECT score parameters.

Disclosure: Nothing to disclose

EPR2054

Focal cortical dysplasia type IIA and IIB: Is there any clinical difference?

J. Jesus-Ribeiro¹, A.F. Jorge², J. Barbosa Melo³, O. Rebelo⁴, C. Pereira⁵, C. Robalo⁵, C. Bento¹, F. Sales¹, A. Freire-Gonçalves²

¹Unidade de Monitorização de Epilepsia e Sono, Serviço de Neurologia, Centro Hospitalar e Universitário de Coimbra (CHUC), Coimbra, Portugal, ²Neurology, Centro Hospitalar e Universitário de Coimbra, Coimbra, Portugal, ³CBR/CIMAGO and Laboratório de Citogenética e Genómica, Faculdade de Medicina da Universidade de Coimbra, Coimbra, Portugal, ⁴Laboratório de Neuropatologia, Serviço de Neurologia, Centro Hospitalar e Universitário de Coimbra (CHUC), Coimbra, Portugal, ⁵Centro de Desenvolvimento da Criança, Hospital Pediátrico, Centro Hospitalar e Universitário de Coimbra (CHUC), Coimbra, Portugal

Background and aims: Focal cortical dysplasia (FCD) type II is divided in 2 subgroups based on absence (IIA) or presence (IIB) of balloon cells. The differences between these 2 entities are not completely understood. The aim of this study was to analyze distinctions between these 2 subgroups regarding clinical features and surgery outcome.

Methods: Cohort study including patients that underwent surgery for drug-resistant epilepsy and had histological proven FCD Type II. Clinical and neuroimaging data and 2-year surgery outcomes (Engel's classification) were obtained.

Results: Six FCD-IIA and 9 FCD-IIB were included. The median age at epilepsy onset was 4 years (IQR 6) in FCD-IIA and 12 years (IQR 20) in FCD-IIB. Regarding seizure characteristics, in FCD-IIA 33% had aura, 83% had impaired awareness, 83% had motor component and 50% had secondary generalization; in FCD-IIB 44% had aura, 67% had impaired awareness, 89% had motor component and 56% had secondary generalization. 83% of FCD-IIA versus 44% of FCD-IIB had daily seizures. Frontal lobe was the most frequent localization in both groups. Surgical outcomes for FCD-IIA were Engel Class I 50%, III 33% and IV 17%; for FCD-IIB were Engel Class I 56%, III 22% and IV 22%. 50% of FCD-IIA patients reduced antiepileptic drugs after 2 years follow-up versus 33% for FCD-IIB.

Conclusion: FCD-IIA patients presented earlier age of epilepsy onset and higher seizure frequency. Seizure semiology was similar despite a higher percentage of impaired awareness in FCD-IIA. Surgery outcomes were similar in both groups, but a higher percentage of FCD-IIA patients reduced antiepileptic drugs during follow-up.

Disclosure: Nothing to disclose

EPR2055

Epilepsy of infancy with migrating focal seizures (EIMFS) due to KCNT1 mutations shows an identifiable temporal sequence and a poor outcome with pharmaco-resistant epilepsy and high mortality with SUDEP

M. Kuchenbuch¹, G. Barcia², N. Chemaly¹, A. Kaminska³, P. Benquet⁴, R. Nabbout¹

¹UMR 1163, Centre de référence des épilepsies rares, service de neuropédiatrie, Institut Imagine, Necker Enfants malades, Paris, France, ²UMR1163 translationnal research, genetic department for neurological disorder, Institut Imagine, Necker-enfants malades, Paris, France, ³Clinical Neurophysiology, Centre De Référence Des Épilepsies Rares, Necker-enfants malades, Paris, France, ⁴LTSI UMR1099, Rennes University, Rennes, France

Background and aims: Assessing data from patients with KCNT1 mutations associated to EIMFS to refine the phenotypic spectrum in particular their long term outcome. **Methods:** We sorted available medical reports of children with KCNT1 mutations and EIMFS followed in the French reference centre for rare epilepsy (2006-2016) and sent a dedicated questionnaire to update their health data for the last 6 months.

Results: 17 patients were included (age: median: 4[25th percentile:2-75th percentile:15] years, sex ratio: 1.4, duration of follow-up: 4[2-15] years). Epilepsy started with sporadic motor seizures in 71% of cases (n=12) at 6[1-52] days. Then, gradually increased to give way to a stormy phase at 57[30-89] days. The remaining patients (29%, n=5) started their epilepsy directly in the stormy phase at 1[1-23] days. On the EEG, interictal suppression patterns were frequent (n=12 patients, 71%). 3 patients received quinidine with no efficacy. 10 patients then entered a 3rd phase called consolidation phase, at 1.3[1-2.8] years. Seizures persisted at least daily (n=8.80%), taking a more frontal aspect. Long-term outcome was poor at 13.6[7.2-16.4] years marked by major mental and motor retardation with an active epilepsy, except for one patient. 8 patients (47%) died at 3[1.5-15.4] years, 3 of them by suspected SUDEP.

Conclusion: Refining the electro-clinical characteristics and the temporal sequence of epilepsy in infancy with migrating focal seizures should help recognizing this epilepsy syndrome. The poor prognosis requires the urgent development of trials targeting the treatment of patients in the stormy phase but also in the consolidation phase.

Disclosure: This work was supported by funds from the French Pediatric Society (PhD 1-year grant) and the French Institute of Health and Medical Research (PhD 2-year grant: poste d'accueil Inserm, M.K.). This work was carried out with the support of the Institute of Clinical Neurosciences in Rennes (INCR).

EPR2056

IL-8 overexpression in Mesial Temporal Lobe Epilepsy with Hippocampal Sclerosis

B. Leal¹, M. Silva², R. Martins-Ferreira¹, J.M.M. Chaves³, R. Rangel⁴, A. Santos⁵, R. Samões³, J. Lopes⁶, J. Ramalheira⁶, B. Martins Da Silva¹, A. Martins Da Silva⁶, P.P Costa⁷

¹Autoimmu and NeuroScien, Unidade Multidisciplinar Invest Biomed, Inst Ciencias Biomed Abel Salazar, Porto, Portugal, ²Immunogenetics Laboratory - Department of Molecular Pathology and Immunology, Institute of Biomedical Sciences Abel Salazar of the University of Porto, Porto, Portugal, ³Department of Neurology, Hospital de Santo António, Centro Hospitalar do Porto, Portugal, Porto, Portugal, ⁴Neurosurgery Service, Hospital de Santo António - Centro Hospitalar e Universitário do Porto, Porto, Portugal, ⁵Delegação Porto, INMLCF, Porto, Portugal, ⁶Neurophysiology Service, Hospital de Santo António - Centro Hospitalar e Universitário do Porto, Porto, Portugal, ⁷Instituto Nacional de Saúde Dr. Ricardo Jorge, Porto, Portugal

Background and aims: Active inflammation is a feature of pharmaco-resistant Mesial Temporal Lobe Epilepsy with Hippocampal Sclerosis (MTLE-HS). One of its manifestations, experimentally corroborated, is the activation of hippocampal microglia with consequent expression of pro-inflammatory cytokines. These molecules can interfere with normal neurotransmission, and contribute to decrease seizure threshold. IL-8 is a microglia-produced chemokine, with the ability to recruit inflammatory cells. Although studies of IL-8 levels during epilepsy are scarce, serum upregulation, correlating with seizure severity, has been reported. The aim of this study was to quantify IL-8 gene expression in brain tissue of MTLE-HS patients.

Methods: IL-8 gene expression was quantified by Real-time PCR in surgically resected hippocampus and cortex of 18 MTLE-HS (10F, 8M, 39.8±8.6y) patients and 10 controls (2F, 8M, 69.7±7.8y). Relative expression values were calculated using the 2- $\Delta\Delta C_t$ method. Patient and Hospital Ethical Committee approval was obtained.

Results: Hippocampal IL-8 expression was higher in MTLE-HS patients in comparing to controls (3.73-fold, p=0.024). IL-8 gene expression was significantly increased in hippocampus of MTLE-HS patients in comparison to cortex of the same patients (4.58-fold; p=0.002); whilst no difference between brain regions were observed (p=0.33) in controls. Cortical IL-8 expression correlated positively with disease duration (rs=0.529; p<0.05).

Conclusion: IL-8 has been associated with Blood-Brain-Barrier disruption and immune cell migration to the Central Nervous System. Hippocampal IL-8 upregulation may thus contribute to the establishment of a vicious cycle of seizure activity – inflammation with disease perpetuation and progressive spreading of inflammation to the adjacent neocortical regions.

Disclosure: Funding: Tecnifar BICE

EPR2057

Can we predict drug response by functional connectivity in patients with juvenile myoclonic epilepsy?

W.G. Lee, B.G. Yoo
 Busan, Korea, Republic of

Background and aims: We investigated functional connectivity in patients with newly diagnosed juvenile myoclonic epilepsy (JME), and whether it could play a role as a biomarker predicting antiepileptic drug (AED) response.

Methods: We consecutively enrolled 38 patients with JME and 40 normal controls. The initial EEG was undertaken at the time of diagnosis of JME. The 2nd MRI was done after at least 12 months from the time of the initial EEG. We classified the patients with JME into 2 groups according to AED response at the time of taking the 2nd EEG. We investigated functional connectivity in the patients with JME and healthy controls.

Results: Of the 38 patients with JME, 4 patients were classified as AED poor responders, whereas 34 patients were enrolled as AED good responders. In the analysis of functional connectivity using coherence as a connectivity measure, the global efficiency and local efficiency in the AED poor responders were decreased, whereas the small-worldness index was increased. In the analysis of functional connectivity using phase locking value as a connectivity measure, the global efficiency and local efficiency in the AED poor responders were decreased. However, in the AED good responders, none of the network measures were different from those in healthy controls.

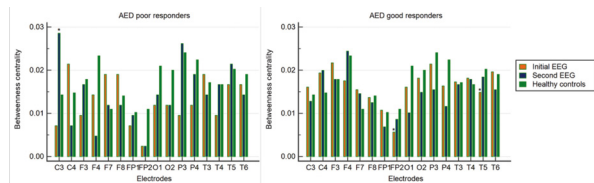

In the analysis of functional connectivity using coherence as a connectivity measure, the betweenness centrality at the Fp2 and T5 electrodes in the AED good responders was decreased compared to that in the healthy controls (0.0058 vs. 0.0109, p=0.0393 at Fp2; 0.0145 vs. 0.0202, p=0.0396 at T5)

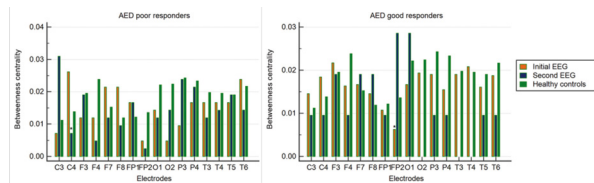

In the analysis of functional connectivity using phase locking value as a connectivity measure, the betweenness centrality at the Fp2 electrode in the AED good responders was decreased compared to that in the healthy controls (0.0064 vs. 0.01357, p=0.0039 at Fp2)

Table 3. Differences of the changes in global functional connectivity according to antiepileptic drug response

AED poor responders				AED good responders					
	Initial EEG, mean ± SD	2nd EEG, mean ± SD	p-value	95% CI		Initial EEG, mean ± SD	2nd EEG, mean ± SD	p-value	95% CI
Coherence					Phase locking value				
Average strength	5.7027 ± 0.1597	5.8100 ± 0.2589	0.2081	-0.3724 to 0.1578	Average strength	4.7179 ± 0.2050	4.8217 ± 0.2414	0.1988	-0.2460 to 0.0794
Characteristic path length	2.8725 ± 0.0842	2.8229 ± 0.1236	0.2628	0.0050 to 0.1646	Characteristic path length	3.483 ± 0.1383	3.4207 ± 0.1441	0.1758	-0.1746 to 0.0506
Clustering coefficient	0.3634 ± 0.0091	0.3694 ± 0.0165	0.3290	-0.0223 to 0.0103	Clustering coefficient	0.3013 ± 0.0123	0.307 ± 0.0143	0.1756	-0.0405 to 0.0157
Global efficiency	0.3870 ± 0.0129	0.3955 ± 0.0175	0.2404	-0.0168 to 0.0099	Global efficiency	0.3224 ± 0.0144	0.3269 ± 0.0163	0.2069	-0.0953 to 0.0162
Local efficiency	0.6062 ± 0.0403	0.6317 ± 0.0561	0.2956	-0.0841 to 0.0330	Local efficiency	0.4202 ± 0.0387	0.4338 ± 0.0460	0.2412	-0.0413 to 0.0161
Small-worldness index	0.9681 ± 0.0103	0.9640 ± 0.0155	0.3393	-0.0074 to 0.0337	Small-worldness index	0.9618 ± 0.0069	0.9611 ± 0.0130	0.8385	-0.0096 to 0.0138
AED good responders				AED poor responders					
Coherence					Phase locking value				
Average strength	6.1809 ± 0.7428	6.2263 ± 0.6510	0.6602	-0.2539 to 0.1611	Average strength	5.2082 ± 0.6243	5.2361 ± 0.5904	0.7346	-0.1938 to 0.1361
Characteristic path length	2.7181 ± 0.2016	2.6927 ± 0.2457	0.5692	-0.0608 to 0.1324	Characteristic path length	3.2426 ± 0.1381	3.2252 ± 0.2899	0.7158	-0.1442 to 0.0793
Clustering coefficient	0.3919 ± 0.0475	0.3951 ± 0.0422	0.6190	-0.0174 to 0.0100	Clustering coefficient	0.3297 ± 0.0386	0.3317 ± 0.0377	0.7046	-0.0809 to 0.0136
Global efficiency	0.4201 ± 0.0493	0.4223 ± 0.0430	0.7494	-0.0159 to 0.0115	Global efficiency	0.3536 ± 0.0422	0.3549 ± 0.0389	0.8005	-0.0096 to 0.0125
Local efficiency	0.7254 ± 0.1798	0.7311 ± 0.1579	0.8126	-0.0536 to 0.0423	Local efficiency	0.5166 ± 0.1315	0.5198 ± 0.1248	0.8514	-0.0371 to 0.0308
Small-worldness index	0.9486 ± 0.0267	0.9501 ± 0.0213	0.7284	-0.0189 to 0.0071	Small-worldness index	0.9436 ± 0.0292	0.9426 ± 0.0262	0.7966	-0.0663 to 0.0081

However, in the AED good responders, none of the network measures were different from those in the healthy controls.

Conclusion: We newly found that there were significant differences of functional connectivity based on initial EEG according to AED response in the patients with JME. This suggests that brain connectivity could play a role as a new biomarker predicting AED response in patients with JME.

Disclosure: Nothing to disclose

EPR2058

Comparing the effectiveness and tolerability of Perampanel and Brivaracetam: a preliminary retrospective, observational study based on real-world data

C. Liguori¹, N. Manfredi², R. Renna³, F. Izzi⁴, M. Pagliuca³, F. Pagliuca³, N.B. Mercuri⁴, F. Placidi⁴

¹Rome, Italy, ²Epilepsy Center, Neurology/Neurophysiopathology Unit, Department of Systems Medicine, University Hospital of Rome "Tor Vergata", Rome, Italy, ³UOC Neurologia, A.O.R.N. "A. Cardarelli", Naples, Italy, ⁴Department of Systems Medicine, University Hospital of Rome Tor Vergata, Rome, Italy

Background and aims: Perampanel (PER) and Brivaracetam (BRV) are 3rd-generation antiepileptic drugs (AEDs). The aim of the present retrospective, double-center study was to compare the effectiveness and tolerability of PER and BRV in patients affected with epilepsy.

Methods: Clinical charts of patients affected by epilepsy admitted to the Epilepsy Centre at the University Hospital of Rome Tor Vergata and the Cardarelli Hospital in Naples were reviewed. Patients started BRV or PER as add-on treatments for controlling seizures and had a follow-up visit of 12 months. We compared seizure freedom, seizure reduction >50%, retention rate, and adverse events reported at the follow-up. Moreover, we considered the effects of both drugs after distributing patients for age (≥60 y.o.), gender, and whether previously treated by Levetiracetam (LEV).

Results: 40 patients treated with BRV and 64 patients treated with PER were included and followed at both sites for 12 months. We found similar effectiveness for both BRV and PER, with similar seizure freedom and seizure reduction >50% at the follow-up. Moreover, PER and BRV discontinuation rates due to inefficiency or adverse events were similar. We also compared the groups of patients who started BRV or PER as 1st add-on treatments and did not observe differences in effectiveness and tolerability. Finally, a better effectiveness of BRV was observed in patients who were not previously treated with LEV.

Conclusion: This retrospective study observed comparable effectiveness and tolerability of PER and BRV as add-on treatments in patients affected with epilepsy, as well as when starting these drugs as first add-on treatments.

Disclosure: Nothing to disclose

EPR2059

Adjunctive Perampanel 4 mg/day for Partial-Onset Seizures (POS): Time to Seizure Onset in Pivotal Phase III Studies

A. Salah¹, A. Patten², M. Malhotra¹

¹Eisai Inc., Woodcliff Lake, NJ, USA, ²Eisai Ltd., Hatfield, Hertfordshire, United Kingdom

Background and aims: Although recommended maintenance dosing of perampanel for POS is 8–12mg/day, some patients may respond to 4mg/day. This post-hoc analysis evaluated the efficacy of adjunctive perampanel 4mg/day for treatment of POS, with/without secondarily generalised seizures (SGS), by assessing time to 1st seizure following perampanel administration.

Methods: During Phase III Studies 304 (NCT00699972), 305 (NCT00699582) and 306 (NCT00700310), patients (aged ≥12 years) with POS, with/without SGS, despite 1–3 anti-seizure medications were randomised to once-daily placebo or adjunctive perampanel 2–12mg/day (19-week Double-blind Treatment Period [6-week Titration; 13-week Maintenance]). Time to 1st seizure from Day 1 of placebo or perampanel administration was assessed in the Intent-to-Treat (ITT) Analysis Set using the Kaplan–Meier method. Placebo data were available from Studies 304, 305 and 306; perampanel 4mg/day data came from Study 306 (the only study to include the randomised 4mg/day dose).

Results: ITT Analysis Set included 437/442 (98.9%) placebo-treated patients (182/185 [98.4%] from Study 306) and 168/172 (97.7%) patients who received perampanel 4mg/day. Perampanel 4mg/day was associated with longer time to 1st seizure vs placebo (Figure). Mean time to 1st seizure was 9.3 days with perampanel 4mg/day vs 4.9 and 4.5 days for Study 306 placebo and pooled placebo, respectively (Table).

Table. Summary statistics for time to first seizure analysis in patients who received placebo or once-daily adjunctive perampanel 4 mg/day (ITT Analysis Set)

	Placebo (Study 306) (n=182)	Pooled placebo (Studies 304, 305, 306) (n=437)	Perampanel 4 mg/day ^a (n=168)
Time to first seizure, days			
Mean (SD)	4.9 (7.10)	4.5 (6.33)	9.3 (22.80)
Median (min, max)	3 (1, 73)	3 (1, 73)	3 (1, 135)

^aData from Study 306.

ITT, intent-to-treat; max, maximum; min, minimum; SD, standard deviation.

Table. Summary statistics for time to first seizure analysis in patients who received placebo or once-daily adjunctive perampanel 4 mg/day (ITT Analysis Set)

Figure. Kaplan–Meier plots of time to first seizure in patients who received placebo in (A) Study 306 or (B) Study 304, 305 or 306, vs once-daily adjunctive perampanel 4 mg/day in Study 306 (inset shows Days 0–14; ITT Analysis Set).

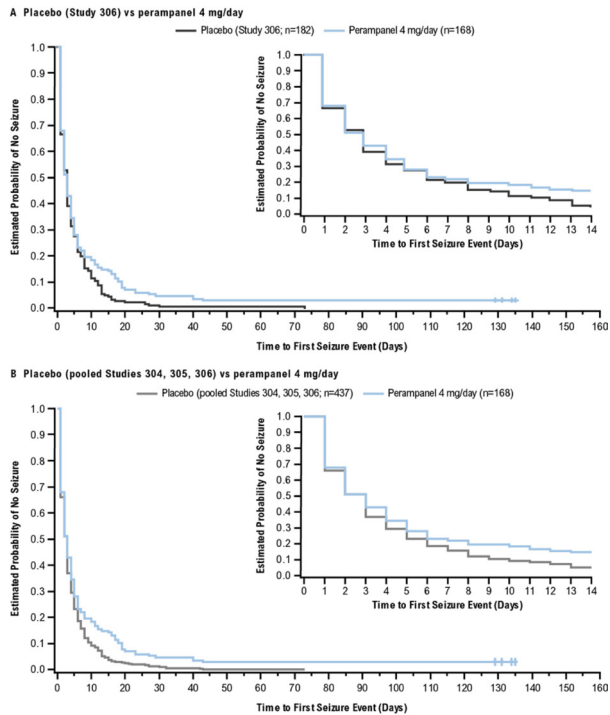

Figure. Kaplan–Meier plots of time to first seizure (ITT Analysis Set)

Conclusion: Adjunctive treatment with once-daily perampanel 4mg/day delayed the time to 1st seizure in patients aged ≥ 12 years with POS, with/without SGS, compared with placebo. These data further support the efficacy of perampanel 4mg/day.

Disclosure: Studies 304, 305 and 306, and this analysis were funded by Eisai Inc. Medical writing support, under the direction of the authors, was provided by Kirsty Muirhead, PhD, of CMC AFFINITY, a division of McCann Health Medical Communications Ltd., Glasgow, UK, in accordance with Good Publication Practice (GPP3) guidelines, funded by Eisai Inc.

EPR2060

NF- κ B subunit p65 is transcriptionally up-regulated in the hippocampus of MTLE-HS patients

R. Martins-Ferreira¹, M. Silva², J. Chaves³, R. Rangel⁴, A. Santos⁵, J. Lopes⁶, J. Ramalheira⁶, B. Martins Da Silva¹, A. Martins Da Silva⁶, P. Pinho E Costa⁷, B. Leal¹

¹Autoimmunity and Neurosciences, Unit for Multidisciplinary Research in Biomedicine (UMIB), Institute of Biomedical Sciences Abel Salazar of the University of Porto, Porto, Portugal, ²Immunogenetics Laboratory - Department of Molecular Pathology and Immunology, Institute of Biomedical Sciences Abel Salazar of the University of Porto, Porto, Portugal, ³Neurology Service, Hospital de Santo António - Porto, Portugal, ⁴Neurosurgery Service, Hospital de Santo António - Porto, Portugal, ⁵Delegation of Porto, National Institute of Legal Medicine, Porto, Portugal, ⁶Neurophysiology Service, Hospital de Santo António - Porto, Portugal, ⁷Department of Human Genetics, Instituto Nacional de Saúde Dr. Ricardo Jorge, Porto, Portugal

Background and aims: Mesial Temporal Lobe Epilepsy with Hippocampal Sclerosis (MTLE-HS) is the most common form of refractory epilepsy. A better understanding and characterization of signalling pathways dysregulated in MTLE-HS is necessary for the development of novel and more efficient treatments. We aimed to evaluate the gene expression of NF- κ B (nuclear factor kappa-light-chain-enhancer of activated B-cells) subunit p65 (RELA gene) in MTLE-HS patients and to correlate it with clinicopathological features.

Methods: Expression levels of RELA were quantified by Real-time PCR in hippocampus and cerebral cortex of 18 MTLE-HS (10F, 8M, 39.8 \pm 8.6 years) patients and 10 controls (2F, 8M, 69.7 \pm 7.8 years). Relative expression values were calculated using the 2- $\Delta\Delta$ Ct method. Correlations were evaluated using Spearman's test. Patient and Hospital Ethical Committee approval was obtained.

Results: RELA was significantly up-regulated in the hippocampus of MTLE-HS patients in comparison to controls (1.97-fold; $p < 0.001$). RELA expression in the cortex of MTLE-patients correlates positively with disease duration ($r_s = 0.529$; $p < 0.05$).

Conclusion: Inflammation is known to occur in epilepsy. It is considered a consequence and/or a cause of seizure activity. The NF- κ B pathway is one of the major inflammation regulatory mechanisms. In epilepsy, increased NF- κ B activity has been reported. However, NF- κ B up-regulation was only previously observed through increased protein levels in hippocampus of MTLE-HS patients. We demonstrated, for the first time, that p65 expression up-regulation in MTLE-HS occurs at the transcriptional level. The association of cortical p65 gene expression with disease duration may indicate progressive spreading of inflammation to the areas surrounding the epilepsy focus with disease progression.

Disclosure: Nothing to disclose

EPR2061

In silico exploration of candidate CpGs uncovers IRAK2 hypomethylation in brain tissue of epilepsy patients

R. Martins-Ferreira¹, B. Leal¹, J. Chaves², A. Garcia-Gomez³, R. Rangel⁴, A. Santos⁵, J. Lopes⁶, J. Ramalheira⁶, B. Martins Da Silva¹, A. Martins Da Silva⁶, P. Pinho E Costa⁷, E. Ballestar³
¹Autoimmunity and Neuroscience Group, Unit for Multidisciplinary Research in Biomedicine (UMIB), Institute of Biomedical Sciences Abel Salazar of University of Porto, Porto, Portugal, ²Neurology Service, Hospital de Santo António - Centro Hospitalar e Universitário do Porto, Porto, Portugal, ³Epigenetics and Immune Disease Group, Josep Carreras Leukaemia Research Institute, Badalona, Spain, ⁴Neurosurgery Service, Hospital de Santo António - Centro Hospitalar e Universitário do Porto, Porto, Portugal, ⁵Delegation of Porto, Instituto Nacional de Medicina Legal e Ciências Forenses, Porto, Portugal, ⁶Neurophysiology Service, Hospital de Santo António - Centro Hospitalar e Universitário do Porto, Porto, Portugal, ⁷Department of Human Genetics, Instituto Nacional de Saúde Dr. Ricardo Jorge, Porto, Portugal

Background and aims: Mesial Temporal Lobe Epilepsy with Hippocampal Sclerosis (MTLE-HS) is the most pharmaco-resistant epilepsy. An epileptogenic phenotype has been described, characterized by persistently dysregulated inflammation-related mechanisms, possibly epigenetically encoded. Genomic cytosine methylation, at CpG dinucleotides (CpGs), is a major epigenetic mechanism of gene expression regulation. Our aim was to evaluate the DNA methylation of specific CpGs, located at regulatory regions of inflammation-related genes in MTLE-HS, selected with an in-silico pipeline.

Methods: 3 publicly available datasets, concerning trans-criptomic (GSE46706) and whole-genome DNA methylation profiling (GSE96615 and GSE111165) were screened for candidate putative differentially methylated CpGs, using a customized statistical approach implemented in R. Methylation percentage of selected candidate CpGs, located at inflammation-related genes including IL1B, IRAK2 and TRAF3, was evaluated using bisulphite pyrosequencing in hippocampus and neocortex of 41 MTLE-HS patients (18M, 23F; aged 39.6±9.8y), comparing to 10 healthy controls (8M, 2F; aged 67.0±10.9y).

Results: We determined significant hypomethylation for two CpGs of the IRAK2 gene. The CpG located at chr3:10215652-10215653 (hg19) was significantly hypomethylated in both hippocampus (6.7±5.1 vs 12.0±2.4, p<0.001) and neocortex (11.0±7.4 vs 22.2±6.9, p<0.001) of MTLE-HS patients vs controls. The chr3:10215713-10215714 (hg19) methylation site showed a similar behaviour in hippocampus (6.8±3.0 vs 10.3±2.3, p<0.001) and neocortex (9.1±5.0 vs 16.5±4.8, p<0.001).

Conclusion: Interleukin-1 receptor-associated kinase 2 (Irak2) is a crucial mediator of TLR/IL-1R-induced signalling, resulting in NFκB activation and pro-inflammatory cytokine expression. NFκB activation and

up-regulation is well documented in epilepsy. However, the epigenetic determinants of this pathway need further exploration.

Disclosure: Nothing to disclose

EPR2062

Epileptic phenotypes, treatment options, and long-term outcomes of autoimmune epilepsies: an Italian multicentre observational cohort study.

S. Matricardi¹, T. Granata², C. Marini¹, S. Casciato³, E. Freri⁴, I. Pappalardo², A. Stabile⁵, A.T. Giallonardo⁶, L. Zuliani⁷, R. Michelucci⁸, A. Gambardella⁹, S. Sartori¹⁰, M. Nosadini¹⁰, E. Ferlazzo¹¹, L. Fusco¹², S. Bozzetti¹³, S. Mariotto¹³, S. Ferrari¹³, F. Villani¹⁴

¹Department of Neuropsychiatry, Children's Hospital "G. Salesi", Ospedali Riuniti, Ancona, Italy, ²Department of Paediatric Neuroscience, Foundation IRCCS Neurological Institute "C. Besta", Milan, Italy, ³IRCCS NEUROMED Pozzilli Italy, ⁴Department of Paediatric Neuroscience, Foundation IRCCS Neurological Institute "C. Besta", Milan, Italy, ⁵Clinical and Experimental Epileptology Unit, Foundation IRCCS Neurological Institute "C. Besta", Milan, Italy, ⁶"La Sapienza" University, Rome, Italy, ⁷Neurology, Treviso Hospital, Treviso, Italy, ⁸Neurology Unit, IRCCS Institute of Neurological Sciences of Bologna, Bellaria Hospital, Bologna, Italy, ⁹Catanzaro, Italy, ¹⁰University Hospital of Padua, Padua, Italy, ¹¹Department of Medical and Surgical Sciences, Magna Graecia University of Catanzaro, Catanzaro, Italy, ¹²Rome, Italy, ¹³VERONA, Italy, ¹⁴Division of Clinical Neurophysiology, Policlinico IRCCS San Martino, Genoa, Italy

Background and aims: Seizures may be a presenting or prominent symptom of autoimmune encephalitis. They are usually resistant to antiepileptic drugs but may benefit from immunotherapy. This study aims to analyse seizure semiology, management, and outcomes of patients with autoimmune encephalitis.

Methods: The Autoimmune Epilepsies Study Group of the Italian League Against Epilepsy performed a multicentre retrospective observational cohort study over 10 years period (2008–2018), and enrolled patients affected by epileptic seizures with an autoimmune aetiology, defined by the detection of pathogenic antibodies or suspected on the clinical and paraclinical basis.

Results: The series comprised 278 patients (65 children, 213 adults), followed-up for a median time of 24 months (range: 16–54 months). Autoantibodies were detected in 60%. Most patients had focal seizures (85%), usually of temporal or bitemporal origin, drug-refractory in 56% of cases. At disease onset, high seizure frequency and episodes of status epilepticus occurred in 68% and 42%, respectively. In the majority of patients (90%), associated symptoms, like neuropsychological deficits, psychiatric symptoms, movement disorders, and decreased consciousness, were also present. Most patients (86%) received immunotherapy. A favourable response, with seizure freedom or significant ($\geq 50\%$) seizure reduction, was detected in those patients who received early immunotherapy, and in those with cell-surface antibodies ($p < 0.05$). Long-term sequelae as psychiatric symptoms and neuropsychological deficits (45%) were present also in seizure-free patients.

Conclusion: Early detection of seizures of definite or possible autoimmune aetiology, may improve the tailored management of the underlying brain dysfunction, likely leading to an improvement of long-term outcomes.

Disclosure: Nothing to disclose

EPR2063

Limbic encephalitis: a single-centre case series

V. Menghi¹, L. Licchetta¹, F. Bisulli¹, M.P. Giannoccaro², P. Avoni¹, C. Stipa², L. Ferri², B. Mostacci², R. Liguori¹, P. Tinuper¹

¹Department of Biomedical and Neuromotor Sciences, University of Bologna, IRCCS Istituto delle Scienze Neurologiche di Bologna, Bologna, Italy, ²IRCCS Istituto delle Scienze Neurologiche di Bologna, Bologna, Italy

Background and aims: To describe the anatomo-electroclinical and prognostic features of patients with limbic encephalitis (LE).

Methods: We reviewed patients referred to our Epilepsy Center from 2004 for a suspicion of autoimmune encephalitis who underwent a comprehensive diagnostic work-up. All cases fulfilling the criteria of LE [Graus et al., 2016] were included.

Results: Out of 16 screened cases, 12 met the criteria of LE (M/F:5/7). The mean age at presentation was 41.8±19.8 years. 9 patients presented with epileptic seizures (3 with status epilepticus), associated with other typical limbic manifestations in 2. 8 patients had focal seizures, 2 faciobrachial dystonic and 2 convulsive seizures. Ictal/interictal EEG showed epileptiform abnormalities in all patients. Brain MRI showed T2-hyperintensities of mesial temporal lobe in 75% of cases. CSF oligoclonal bands were detected in 4. Antibody testing was positive in 4 (33%; 2 with anti-GAD65 and 2 anti-Lgi1 antibodies); 1 patient with anti-GAD65 antibodies had also stiff-limb syndrome. 3 seronegative cases were diagnosed with paraneoplastic LE. 10 patients received 1st-line immunotherapies with improvement in 6; 2 were treated with rituximab/azathioprine with partial seizure control. After a mean follow-up-period of 7.3±4 years seizures/neuropsychological deficits persisted in 8 and 9 cases, respectively (2 with anti-GAD65 antibodies).

Conclusion: We describe 12 LE patients, 4 of whom with anti-GAD65/Lgi1 antibodies, 3 with paraneoplastic LE and 5 seronegative. Faciobrachial dystonic seizures were specifically associated with raised Lgi1 antibodies [Irani et al., 2011]; in these cases early immunotherapy was effective in terms of seizures/cognitive outcome. Among seropositive cases, anti-GAD65 antibodies-related LE showed the worst outcome.

Disclosure: Nothing to disclose

EPR2064

Targeting CD40L-CD40 in Epilepsy

A. Musto¹, A. Ojeda¹, D. Sharma², K. Major², R. Fisher³, E. Pototsky¹

¹Pathology & Anatomy, EVMS, Norfolk, USA, ²School of Medicine, EVMS, Norfolk, USA, ³Biomedical Science, EVMS, Norfolk, USA

Background and aims: Previously, we showed that CD40 deficiency downregulates seizure severity, increases seizure latency, and reduces seizure frequency in an experimental model of acute seizures. Therefore, the goal of this research was to determine if upregulation of CD40 and CD40L mediate epilepsy.

Methods: Status epilepticus (SE) was induced in adult male CD40 receptor deficient mice (CD40KO) and its respective wild type mice using pilocarpine model in epilepsy. Silicon probe with 16 microelectrodes was implanted in hippocampus 10 days prior to SE. Simultaneous video and local field potentials (V-LFP) were recorded before, during, and after SE. Clinical and electrical seizures were quantified daily over 4 weeks. Brain concentration of CD40-CD40L, neuronal damage and neuroinflammation was analyzed. In addition, in a group of WT mice, Anti-CD40 (BioXCell InVivoMAb anti-mouse CD40L (CD154) or vehicle (sterile saline) were administered intranasal 2 hours before seizure induction with pentylenetetrazole.

Results: Preliminary results show that concentration of CD40 and CD40L markedly increased in the cortex and hippocampus from Day 1 to Day 22 after SE. Upregulation of CD40L-CD40 was positively correlated with an increase of p38 and phosphorylated-p38, neuronal damage, gliosis and spontaneous seizures. CD40KO mice presented a reduction of spontaneous seizures, gliosis and neuronal damage compare to WT. Also, CD40KO mice showed a reduction of gamma oscillation after seizure. Also, antiCD40L administration limited seizure severity and increased latency for stage 3 seizure compare to vehicle.

Conclusion: These preliminary findings indicate that up-regulation of CD40L-CD40 could mediate epileptogenesis by influencing inflammatory mechanisms that involve and propagate seizure-induced neuronal damage.

Disclosure: Nothing to disclose

Headache and pain 3

EPR2065

Pooled Analysis of Cardiovascular Safety With Fremanezumab Treatment in Patients With Migraine and Concomitant Triptan Use

M. Kärppä¹, X. Ning², Y. Kessler², J.M. Cohen², R. Yang², L. Pazdera³

¹Department of Neurology, Oulu University Hospital, Oulu, Finland, ²Teva Branded Pharmaceutical Products R&D, Inc., West Chester, PA, USA, ³Vestra Clinics, Rychnov nad Kněžnou, Czech Republic

Background and aims: Fremanezumab, a fully-humanised monoclonal antibody (IgG2Δa) that selectively targets calcitonin gene-related peptide (CGRP), has proven efficacy for the preventive treatment of migraine in adults. Given the frequency of triptan use in patients with migraine, it is important to evaluate whether concomitant use of triptans with fremanezumab raises any safety concerns.

Methods: This analysis included data from three phase 3 trials (HALO EM, HALO CM, and FOCUS), in which patients were randomised 1:1:1 to receive subcutaneous quarterly or monthly fremanezumab or matched monthly placebo over 12 weeks. Cardiovascular adverse events (CVAEs) were evaluated in patients with and without triptan use.

Results: Of the total pooled population (N=2,842), 1,123 (40%) used triptans during the studies, with similar proportions using triptans across all treatment groups. Of patients with triptan use, 19 (2%) of patients experienced ≥1 CVAE (Table) with no difference between placebo and fremanezumab-treated patients noted. Occurrences of CVAEs were consistently low across all treatment groups; the only CVAE with >1 occurrence in the placebo and fremanezumab groups was hypertension (Table). The incidence of CVAEs was low and similar in patients without triptan use (n=1,719; 46 [3%]). Among patients without triptan use (not shown), CVAEs with >1 occurrence in any treatment group were palpitations, hypertension, hematoma and hot flush, and all were reported in ≤1% of patients.

Table. CVAEs in Patients With Concomitant Triptan Use

AEs, n (%)	Fremanezumab			
	Placebo (N=365)	Quarterly fremanezumab (N=393)	Monthly fremanezumab 675mg/225mg/225mg (N=202)	Monthly fremanezumab 225mg/225mg/225mg (N=163)
Patients with ≥1 CVAE	6 (2)	6 (2)	5 (2)	2 (1)
Palpitations	1 (<1)	1 (<1)	0	0
Tachycardia	1 (<1)	0	0	0
Heart rate increased	1 (<1)	1 (<1)	1 (<1)	1 (<1)
Blood pressure increased	1 (<1)	1 (<1)	0	0
ECG PR prolongation	0	1 (<1)	0	0
ECG QT prolonged	0	0	0	1 (<1)
Hypertension	2 (<1)	2 (<1)	1 (<1)	0
Hypotension	0	0	1 (<1)	0
Peripheral coldness	0	0	1 (<1)	0
Raynaud's phenomenon	0	0	1 (<1)	0

CV, cardiovascular; AE, adverse event; ECG, electrocardiogram.

Conclusion: This pooled analysis demonstrates that fremanezumab treatment over 12 weeks was well tolerated in patients with migraine and concomitant triptan use, with similar CV tolerability to those with no triptan use.

Disclosure: This study was funded by Teva Pharmaceuticals.

EPR2066

Prodromal symptoms in cluster headache: A prospective multicenter study

B.-K. Kim¹, S. Cho², S.-J. Cho³, M.J. Lee², M.K. Chu⁴

¹Seoul, Korea, Republic of, ²Neurology, Samsung Medical Center, Seoul, Korea, Republic of, ³Neurology, Dongtan Sacred Heart Hospital, Seoul, Korea, Republic of,

⁴Neurology, Severance Hospital, Seoul, Korea, Republic of

Background and aims: Epidemiological data of prodromal symptoms of cluster headaches (CH) are scarce in the literatures. Here, we investigated the prevalence and clinical characteristics of prodromal symptoms of CH.

Methods: This is a prospective multicenter study that enrolled consecutive patients with CH from 11 hospitals. We defined symptoms occurring minutes and hours before an individual attack as pre-attack symptoms, and symptoms occurring days and weeks before an upcoming cluster bout as pre-cluster symptoms. Patients underwent a semi-structured interview about the presence of 21 symptoms/signs in relation to cluster headache. The diagnosis of CH was verified according to ICHD-3 criteria. We excluded patients with probable CH and chronic CH.

Results: In total, 116 patients were enrolled. Pre-attack symptoms were reported by 65.5%, with an average of 2.5 per patients. Most patients experienced pre-attack symptoms within 30 minutes before a cluster attack. The most frequently reported symptoms were a local pain (51.3%) and sensory symptoms (12.9%) in the area of subsequent attack, followed by generalized symptoms (44.7%), neck pain (32.9%), autonomic symptoms (15.8%) and agitation (9.2%). Pre-cluster symptoms were found in 22.4% of participants. 81.9% experienced pre-cluster symptoms within 2 weeks before a cluster bout. The most frequently reported symptoms were a local pain (47.8%). Subjects with pre-attack symptoms were more likely to experience pre-cluster symptoms (p=0.01).

Conclusion: Prodromal symptoms are frequent in CH. Understanding of prodromal symptoms of CH could contribute to the preemptive treatment strategies for the prevention of CH.

Disclosure: Nothing to disclose

EPR2067

The importance of considering the patient's and treating physician's view to generate comprehensive und unbiased real-world evidence data.

K. Schuh¹, C. Gaul², A. Straube³, P. Stude⁴,
H. Israel-Willner⁵, M. Koch¹

¹TA Neuroscience, Novartis Pharma GmbH, Nuremberg, Germany, ²Königstein, Germany, ³Department of Neurology, Klinikum Grosshadern, Munich, Germany, ⁴Neurologische Praxis Bochum, Bochum, Germany, ⁵Klinik für Neurologie, Berlin, Germany

Background and aims: Real-World-Evidence can be collected from different perspectives – the patients' and treating physicians' perspective. Here, we describe the importance of considering the views of both patients and physicians in order to gather comprehensive real-life evidence.

Methods: Between July and December 2019, 2 independent online surveys were conducted in Germany to collect data from a) migraine patients regarding their experience with erenumab (PERISCOPE) and b) migraine-treating physicians regarding their therapy decisions and observations upon erenumab treatment (TELESCOPE). Results were compared regarding the overall therapy outcome, changes in quality of life and influence of quality of life parameters.

Results: The interim analyses of PERISCOPE (90 erenumab patients) and TELESCOPE (30 physicians with 354 erenumab patients) showed that 75% of all physicians already detected improvement after the 1st injection, but only 49% of patients reported a response after their 1st treatment. Further, patients and physicians weighted quality of life parameters differently. However, patients and physicians both reported a reduction of ~7 migraine days after 3 months of treatment. At EAN, the comparison of both full data sets will be presented including 155 erenumab patients (PERISCOPE) and 45 physicians/522 erenumab patients (TELESCOPE).

Conclusion: These analyses indicate differences and overlaps in the patients and physicians perception of therapy outcomes in migraine treatment. The comparison highlights the importance of understanding limitations of the interviewed population and thus shows that only considering both sides will generate comprehensive real-world evidence for treatment options.

Disclosure: This study has been funded by Novartis Pharma GmbH.

EPR2068

Analysis of the patient population for the assessment of long-term safety and tolerability of the monoclonal antibody Erenumab and the frequency of drug holidays in the German treatment algorithm

H. Göbel¹, M. Groth², M. Koch³

¹Migräne- und Kopfschmerzzentrum, Kiel, Germany, ²Novartis Pharma GmbH, Nuremberg, Germany, ³TA Neuroscience, Novartis Pharma GmbH, Nuremberg, Germany

Background and aims: In 2018, EMA and FDA approved erenumab for its safety and efficacy. Recently, 4.5-year data from an ongoing open-label treatment phase confirmed the long-term safety profile of erenumab in an international cohort. However, long-term data is still limited for the German population. Further, the impact and relevance of a drug holiday suggested by the German guidelines for migraine therapy by the DMKG (DGN 2018), which is suggested after 6-12 months of treatment should be investigated.

Methods: APOLLON is a 128-week open-label study of erenumab treatment, assessing long-term safety and tolerability data of migraine patients in Germany who previously participated in a head-to-head trial comparing the tolerability of erenumab and topiramate (NCT03828539). At scheduled visit, the treating physician can change the erenumab dose according to the approved label and. Thereby, monthly migraine days 4 weeks to, during and 12 weeks after the medication-free period are documented. In an interim analysis baseline characteristics and the current and planned drug holidays will be analyzed.

Results: At EAN we will present an analysis of the baseline characteristics of the approximately and an analysis of the number and time point of current and planned drug holidays in the treatment scheme.

Conclusion: This analysis will provide insights into the patient population as regards the assessment of long-term safety and tolerability of erenumab and the frequency and timeline for drug holidays during erenumab treatment in the treatment algorithm of approximately 80 German headache centers.

Disclosure: This study has been funded by Novartis Pharma GmbH.

EPR2069

Sentinel headache as a predictor of ischemic stroke

E.R. Lebedeva¹, A.V. Ushenin², N.M. Gurary³,
D.V. Gilev⁴, J. Olesen⁵

¹International Headache Center "Europe-Asia", the Ural State Medical University, Yekaterinburg, Russian Federation, ²Neurology, the Ural State Medical University, Yekaterinburg, Russian Federation, ³Neurological Department, Medical Union New Hospital, Ykaterinburg, Russian Federation, ⁴Department of Econometrics and Statistics, the Graduate school of Economics and Management, the Ural Federal University, Yekaterinburg, Russian Federation, ⁵Danish Headache Center, Department of Neurology, Rigshospitalet-Glostrup, University of Copenhagen, Copenhagen, Denmark

Background and aims: There are no previous controlled studies of sentinel headache in ischemic stroke. The purpose of the present study was to evaluate the presence of such headache, its characteristics and possible risk factors as compared to a simultaneous control group.

Methods: Eligible patients (n=550) had 1st-ever acute ischemic stroke with presence of new infarction on magnetic resonance imaging with diffusion-weighted imaging (n=469) or on computed tomography (n=81). As a control group we studied in parallel patients (n=192) who were admitted to the emergency room without acute neurological deficits or serious neurological or somatic disorders. Consecutive patients with stroke and a simultaneous control group were extensively interviewed soon after admission using validated neurologist conducted semi-structured interview forms.

Results: Among 550 patients with stroke 94 patients (17.1%) had headache during seven days before stroke and 12 (6.2%) of controls (p<0.001; OR 3.9; 95% CI 1.7-5.8). We defined sentinel headache as a new type of headache or a previous kind of headache with altered characteristics (severe intensity, increased frequency, absence of effect of drugs) within seven days before stroke. had Attacks of arrhythmia during seven days before stroke were significantly associated with sentinel headache (p=0.04, OR 2.3; 95% CI 1.1-4.8).

Conclusion: A new type of headache and a previous kind of headache with altered characteristics during one week before stroke are significantly more prevalent than in controls. Such sentinel headache should prompt urgent examination for stroke prevention.

Disclosure: Nothing to disclose

EPR2070

Abnormal cerebrovascular changes in sporadic hemiplegic migraine

L.Y. Long¹, K. Narasimhalu², Y. Zhao², S. Wee²

¹Singapore, Singapore, ²National Neuroscience Institute, Singapore, Singapore

Background: The pathophysiology of sporadic hemiplegic migraine (SHM) is not well understood. Cortical spreading depression affecting motor excitability and neurovascular coupling may be integral to development of weakness.

Aims: To study hemodynamic responses to a motor activation task in SHM patients using functional near-infrared spectroscopy (fNIRS), during the interictal period.

Methods: A total of 9 right-handed patients and 17 healthy controls were enrolled. Patients were diagnosed with SHM in accordance to IHS criteria, and studied after recovery from the hemiplegic episode. All patients had normal MR brain imaging. Each performed a finger opposition tasks at maximal velocity with simultaneous fNIRS recording.

Results: During motor activation, patients with SHM were less likely to demonstrate increase in oxyhemoglobin (oxyHb) ipsilateral and contralateral to the side of motor activation task than in controls (p=0.002). However, the area of involvement is larger on the side contralateral to motor activation (3 vs. 1 recording site). There were no significant differences found for deoxyhemoglobin (deoxHb) recordings.

Conclusion: Our findings suggest presence of an abnormal interictal hemodynamic response to increased metabolic demands during motor activation in SHM. In addition, these cerebrovascular changes appear to be more pronounced contralateral to the side of activation.

Disclosure: Nothing to disclose

EPR2071

Galcanezumab in patients with treatment-resistant migraine: results from the open-label phase of the CONQUER phase 3 trial

H.C. Detke¹, U. Reuter², C. Lucas³, D. Dolezil⁴, A. Hand⁵, A. Tockhorn-Heidenreich⁶, C. Stroud⁷, S.K. Aurora⁸

¹Eli Lilly and Company, Indianapolis, IN, USA, ²Charité Universitätsmedizin Berlin, Berlin, Germany, ³Pain Clinic, Service de Neurochirurgie, Hôpital Salengro, CHRU de Lille, Lille, France, ⁴Prague Headache Center, DADO MEDICAL s.r.o, Prague, Czech Republic, ⁵IQVIA, Durham, NC, USA, ⁶GPORWE-ACE HO & HTA, Eli Lilly and Company, Indianapolis, USA, ⁷Clinical, Eli Lilly and Company, Indianapolis, USA, ⁸Eli Lilly and Company, Indianapolis, USA

Background and aims: This study assessed 6-month efficacy and safety of galcanezumab in patients with treatment-resistant migraine.

Methods: During double-blind treatment (Months 1-3), 462 patients (18-75 years) with episodic or chronic migraine and 2-4 previous migraine preventive medication category failures were randomised 1:1 to injections of placebo or galcanezumab 120mg/month (with 240mg loading dose). After completing double-blind treatment, patients could enter an open-label extension (OLE; Months 4-6), in which all patients received galcanezumab 120mg/month. The primary endpoint was mean change from baseline in number of monthly migraine headache days. Key secondary endpoints included response rate ($\geq 50\%$ reduction in monthly migraine headache days) and mean change in Migraine-Specific Quality of Life Questionnaire Role Function-Restrictive domain score (MSQ-RFR).

Results: Of 451 patients who completed double-blind treatment, 449 entered the OLE, with 432 (96%) completing. From a baseline of approximately 13 monthly migraine headache days, the mean decrease at Month 6 was >5 days. At Month 6, approximately 54% of patients met the $\geq 50\%$ response criterion. Of the 87 galcanezumab-treated patients with $\geq 50\%$ response at double-blind treatment end, 52% maintained that response throughout OLE. Mean MSQ-RFR scores improved from baseline (score=45) to Month 6 by approximately 27 points on a 100-point scale.

Treatment-emergent adverse events occurring in $>2\%$ of patients were nasopharyngitis (4%), injection-site pain (4%), and injection-site erythema (3%). 5 patients (1%) discontinued due to an adverse event. There were no clinically meaningful changes in any safety parameters.

Conclusion: Galcanezumab was effective, safe, and well tolerated during the CONQUER open-label extension in patients with treatment-resistant migraine.

Disclosure: This research was supported by Eli Lilly and Company.

EPR2072

Eptinezumab Reduced Acute Medication Use in Patients with Chronic Migraine and Medication-Overuse Headache: Subgroup Analysis of PROMISE-2

M. Marmura¹, H.-C. Diener², J. Hirman³, R. Cady⁴, T. Brevig⁵, E. Brunner⁶, L. Mehta⁴

¹Jefferson Headache Center, Thomas Jefferson University Hospitals, Philadelphia, PA, USA, ²Institute for Medical Informatics, Biometry and Epidemiology, Medical Faculty of the University Duisburg-Essen, Essen, Germany, ³Pacific Northwest Statistical Consulting, Inc., Woodinville, WA, USA, ⁴Lundbeck Seattle BioPharmaceuticals, Inc., Bothell, WA, USA, ⁵H. Lundbeck A/S, Copenhagen, Denmark, ⁶Lundbeck LLC, Deerfield, IL, USA

Background and aims: Eptinezumab is a monoclonal antibody that inhibits CGRP for the prevention of migraine. This analysis evaluated the impact of eptinezumab on acute headache medication use in patients enrolled in the pivotal PROMISE-2 clinical trial who were given a dual diagnosis of chronic migraine (CM) and medication-overuse headache (MOH).

Methods: In PROMISE-2, patients with CM were randomized to eptinezumab 100mg, 300mg, or placebo for 2 intravenous doses administered every 12 weeks. MOH was diagnosed by trained investigators at screening based on 3 months of medication history and in alignment with ICHD-3b criteria. Endpoints included days/month of any acute medication use (days of ≥ 1 medication class), total acute medication use days/month (sum of days for each medication class), and days/month with triptan use over Weeks 1-12 and 13-24. Classes of acute medication included triptan, ergot, opioid, simple analgesic, and combination analgesic.

Results: Of 1072 patients treated in PROMISE-2, 431 (40.2%) were diagnosed with MOH (100mg, n=139; 300mg, n=147; placebo, n=145). During the 28-day baseline period, the mean days of any acute medication use was ~ 16.4 , total acute medication use was ~ 20.4 , and triptan use was ~ 8.9 across treatment arms. Over Weeks 1-12, mean days/month of any acute medication use was 8.8 (100mg), 9.9 (300mg), and 11.8 (placebo); total acute medication use was 10.8, 12.2, and 14.8; and triptan use was 4.3, 4.4, and 6.4. Similar or lower rates were observed over Weeks 13-24.

Conclusion: In patients diagnosed with both CM and MOH, eptinezumab treatment reduced acute headache medication use.

Disclosure: H. Lundbeck A/S, Copenhagen, Denmark

EPR2073

Wavelet-transform coherence analysis to assess the dynamic changes of the brain during NTG-induced migraine attacks

G. Castellazzi¹, D. Martinelli², R. De Icco², G. Savini³, A. Bacila⁴, M. Allena⁵, E. Guaschino⁶, G. Sances⁵, C. Wheeler-Kingshott¹, A. Pichiecchio⁷, C. Tassorelli²
¹Neuroinflammation, Institute of Neurology, London, United Kingdom, ²Pavia Headache Centre, C. Mondino National Institute of Neurology Foundation, IRCCS, Dept. of Brain and Behavioral Sciences University of Pavia, Pavia, Italy, ³Brain MRI 3T Center, IRCCS Mondino Foundation, Pavia, Italy, ⁴Neuroradiology Unit, IRCCS Mondino Foundation, Pavia, Italy, ⁵Headache Science Centre, C. Mondino National Neurological Institute, Pavia, Italy, ⁶Headache Science Center, C. Mondino National Neurological Institute, Pavia, Italy, ⁷C. Mondino National Neurological Institute, Pavia, Italy

Background and aims: Migraine is a cyclical disorder where the attack evolves over the span of hours to days. Resting state functional MRI (rs-fMRI) has been widely used to study the brain functional connectivity changes during migraine attacks, helping to better understand the complex mechanisms underlying this disorder. In this pilot study, we aimed to investigate the functional connectivity of the migraine brain using dynamic rs-fMRI analysis. To this end, the Wavelet Transform Coherence (WTC) approach, which allows to estimate the changes in the dynamic interactions between rs-fMRI signals from distinct brain areas, was applied to study the coherence between the salience network (SN) and the thalamus rs-fMRI signals during the different phases of a nitroglycerin (NTG)-induced episodic migraine attack.

Methods: 5 episodic migraineurs underwent 3T MRI examination consisting in 4 rs-fMRI repetitions matched with the different phases of an attack: baseline, prodromal, full-blown attack, recovery. Subjects' rs-fMRI data were processed to extract the SN and thalamic time-courses. The extracted time-series were treated with WTC to obtain a wavelet coherence map from which the time-in-phase coherence between SN and thalamic signals was assessed.

Results: Results revealed that in all subjects both right and left thalamic rs-fMRI signals were significantly ($p < 0.05$) anti-correlated with the SN time-course during the prodromal phase, while they showed significant in-phase correlation with SN during the full-blown attack.

WCT: Salience Network vs. right Thalamus

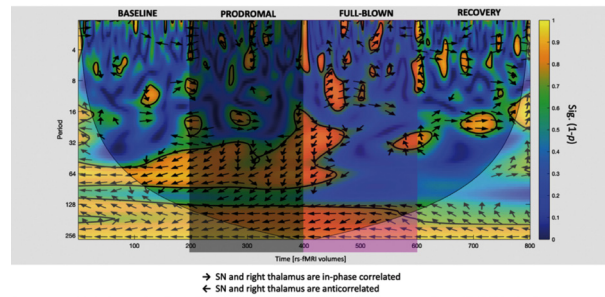

Wavelet coherence map showing the WTC results between the SN and the right thalamus rs-fMRI time-courses.

WCT: Salience Network vs. left Thalamus

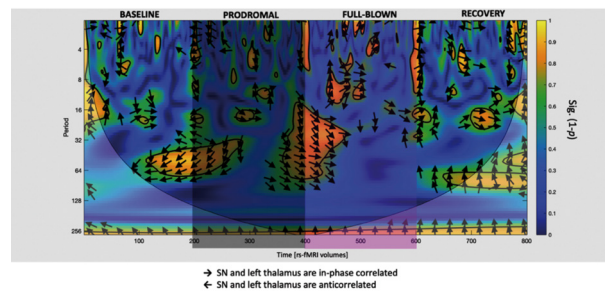

Wavelet coherence map showing the WTC results between the SN and the left thalamus rs-fMRI time-courses.

Conclusion: Overall, these results suggest that the temporal dynamic alterations of brain functional circuitries implicated in pain processing are differently involved during the attack and may play a key role in modulating the migraine experience.

Disclosure: Nothing to disclose

EPR2074

Efficacy of Galcanezumab In Patients with Migraine and History of Failure to at least Three Preventive Treatment Categories: Subgroup Results from CONQUER Study

R. Okonkwo¹, A. Tockhorn-Heidenreich¹, C. Stroud¹, M.-A. Paget¹, M.S. Matharu², C. Tassorelli³
¹Eli Lilly and Company, Indianapolis, USA, ²University College London (UCL) Queen Square Institute of Neurology and National Hospital for Neurology and Neurosurgery, London, UK, London, United Kingdom, ³Headache Science Centre, C. Mondino Foundation and Dept of Brain and Behavioural Sciences, University of Pavia, Pavia, Italy

Background and aims: CONQUER (NCT03559257) was a Phase 3, multicenter, randomized controlled trial in patients with episodic (EM) or chronic (CM) migraine who had 2–4 preventive category failures. We report efficacy outcomes from pre-specified subgroup of patients with three or more (≥3) preventive category failures, given the large unmet need in this population.

Methods: Eligible patients in CONQUER were aged 18–75 years, had 4–29 migraine headache days/month, and 2–4 migraine preventive medication category failures in past 10 years (reasons: inadequate efficacy and/or safety/tolerability). Patients were randomized 1:1 to monthly subcutaneous injections of galcanezumab_120mg (loading dose: 240mg) or placebo during the 3-month double-blind treatment period. Evaluated endpoints include overall mean change from baseline (CFB) of monthly migraine headache days across Month 1–3, overall proportion of patients achieving ≥50% reduction in monthly migraine headache days (Months 1–3) and mean CFB on the migraine-specific quality of life role function-restrictive (MSQ RF-R) domain (at Month 3).

Table 1. Baseline demographics and disease characteristics among patients with failures to three or more preventive categories* in CONQUER Study.

	Episodic migraine (N=100)	Chronic migraine (N=86)	Total Population (N=186)
Galcanezumab_120mg, n (%)	56 (56.0)	43 (50.0)	99 (53.2)
Placebo, n (%)	44 (44.0)	43 (50.0)	87 (46.8)
Demographics			
Age, years, mean (SD)	46.0 (11.5)	45.5 (12.5)	45.8 (11.9)
Gender (female), n (%)	83 (83.0)	72 (83.7)	155 (83.3)
Disease Characteristics			
Duration of migraine, years, mean (SD)	21.4 (13.8)	24.5 (15.5)	22.8 (14.7)
Migraine headache days/month, mean (SD)	9.9 (2.7)	18.8 (4.7)	14.0 (5.8)
Migraine attacks/month, mean (SD)	5.8 (1.7)	6.2 (2.3)	6.0 (2.0)
Headache days/month, mean (SD)	11.1 (2.5)	21.0 (4.5)	15.7 (6.1)
MSQ Role Function-Restrictive, mean (SD)	48.4 (16.9)	38.4 (18.9)	43.8 (18.5)
Acute Medication overuse, n (%)	36 (36.0)	63 (73.3)	99 (53.2)

MSQ, migraine-specific quality of life questionnaire; SD, standard deviation. *Following is the list of preventive categories: propranolol or metoprolol; topiramate; valproate or divalproex; amitriptyline; flunarizine; candesartan; botulinum toxin A or B (if documented that botulinum toxin was taken for chronic migraine); medication locally approved for prevention of migraine.

Table 1

Results: Of the 462 randomised patients, 186 (40.3%) had history of ≥3 preventive category failures (Table 1). For these patients, galcanezumab_120mg led to a significantly larger overall mean (SE) reduction in monthly migraine headache days versus placebo (p<0.001) for both populations: EM: galcanezumab_120mg: -3.6 (0.6); placebo: -0.7 (0.7); CM: galcanezumab_120mg: -6.7 (1.2);

placebo: -1.6 (1.1). Galcanezumab was also superior to placebo for ≥50% response and for improvements in MSQ RF-R score (Table 2).

Table 2. Efficacy measures in patients with failures to three or more preventive categories* in CONQUER Study.

Endpoint	Treatment	Episodic migraine		Chronic migraine		All Population	
		LS mean change (SE) / estimated rate (SE)	LS mean change difference (SE) / odds ratio (95% CI) (vs. placebo)	LS mean change / estimated rate (SE)	LS mean change difference (SE) / odds ratio (95% CI) (vs. placebo)	LS mean change (SE) / estimated rate (SE)	LS mean change difference (SE) / odds ratio (95% CI) (vs. placebo)
Monthly migraine headache days	Placebo	-0.7 (0.7)	---	-1.6 (1.1)	---	-1.0 (0.7)	---
	GMB 120	-3.6 (0.6)	-3.0 (0.8) [†]	-6.7 (1.2)	-5.1 (1.3) [†]	-5.5 (0.7)	-4.5 (0.7) [†]
≥50% response	Placebo	16.5 (4.1)	---	8.4 (3.9)	---	12.7 (2.9)	---
	GMB 120	41.1 (4.9)	3.5 (1.7, 7.3) [†]	41.5 (6.9)	7.8 (2.4, 24.8) [†]	41.0 (4.0)	4.8 (2.6, 8.7) [†]
MSQ Role Function-Restrictive ^b	Placebo	14.5 (3.6)	---	4.7 (3.4)	---	12.0 (2.8)	---
	GMB 120	22.7 (3.4)	8.2 (4.0) [*]	25.2 (3.6)	20.5 (4.2) [†]	27.3 (2.7)	15.3 (3.0) [†]

CI, confidence interval; MSQ, migraine-specific quality of life questionnaire; LS, least squares; SE, standard error; [†]p<0.05; ^{††}p<0.001. *Following is the list of preventive categories: propranolol or metoprolol; topiramate; valproate or divalproex; amitriptyline; flunarizine; candesartan; botulinum toxin A or B (if documented that botulinum toxin was taken for chronic migraine); medication locally approved for prevention of migraine. ^bAt Month 3

Table 2

Conclusion: In patients with ≥3 migraine preventive medication category failures, galcanezumab led to significant improvements in key efficacy outcomes over placebo.

Disclosure: The study was sponsored by Eli Lilly and Company, Indianapolis, Indiana, USA.

Headache and pain 4

EPR2075

Improvements in Quality-of-Life, Productivity, and Satisfaction With Fremanezumab in Migraine Patients ≥ 60 Years of Age: Pooled Results of 3 Randomised, Double-blind, Placebo-controlled Phase 3 Studies

P. McAllister¹, X. Ning², J.M. Cohen², L.J. Krasenbaum², R. Yang²

¹New England Institute for Neurology and Headache, Stamford, CT, USA, ²Teva Branded Pharmaceutical Products R&D, Inc., West Chester, PA, USA

Background and aims: Migraine is a leading cause of disability and negatively affects patients' quality of life. The impact of fremanezumab, a fully-humanised monoclonal antibody (IgG2 Δ a) that selectively targets calcitonin gene-related peptide (CGRP), on health-related quality of life (HRQoL) in a subgroup of patients ≥ 60 years of age was evaluated in this pooled analysis.

Methods: This analysis in patients ≥ 60 years of age with episodic migraine (EM) or chronic migraine (CM) included data from three phase 3 studies (HALO EM, HALO CM, and FOCUS), in which patients were randomised 1:1:1 to receive subcutaneous quarterly or monthly fremanezumab or matched monthly placebo over 12 weeks. Mean changes from baseline in Migraine-Specific Quality of Life (MSQoL) and Work Productivity and Activity Impairment (WPAI) questionnaire scores and proportions of Patient Global Impression of Change (PGIC) responders (rating, 5–7) over 12 weeks were evaluated.

Results: Overall, 246 patients ≥ 60 years of age were included in these analyses. Over 12 weeks, greater improvements from baseline were observed with both fremanezumab dosing regimens versus placebo across all MSQoL domains and WPAI percent work time missed due to health and percent impairment while working due to health domains (Table). Proportions of responders on the PGIC scale were also significantly higher with both quarterly (59%) and monthly (64%) fremanezumab versus placebo (40%, $P < 0.01$).

Table. Change From Baseline in WPAI and MSQoL in Patients ≥ 60 Years of Age During 12 Weeks of Double-blind Treatment

	Placebo (n=80)	Quarterly fremanezumab (n=74)	Monthly fremanezumab (n=92)
Change from BL in WPAI domains, LSM (SE)*			
Percent work time missed due to health	-5.0 (1.66)	-4.3 (1.65)	-3.4 (1.58)
Percent impairment while working due to health	-4.1 (3.16)	-17.0 (3.08) ^b	-12.9 (3.00) ^b
Percent overall work impairment due to health	-5.7 (3.59)	-17.9 (3.52) ^b	-14.1 (3.42)
Change from BL in MSQoL domains, LSM (SE)			
Role-function restrictive	9.6 (2.07)	15.9 (2.13) ^b	18.9 (1.97) ^b
Role-function preventive	10.8 (1.86)	13.5 (1.93)	14.2 (1.79)
Emotional function	13.7 (1.92)	20.3 (1.98) ^b	18.8 (1.84) ^b

WPAI, Work Productivity and Activity Impairment; MSQoL, Migraine-Specific Quality of Life; LSM, least-squares mean; SE, standard error.

*Assessed in patients who were working; placebo, n=32; fremanezumab quarterly, n=32; fremanezumab monthly, n=35.

^b $P < 0.01$ versus placebo.

^c $P < 0.05$ versus placebo.

Conclusion: This pooled analysis demonstrates that both fremanezumab treatment regimens over 12 weeks improved HRQoL, productivity, and satisfaction, as measured by MSQoL, WPAI, and PGIC, respectively, in patients ≥ 60 years of age with EM or CM.

Disclosure: This study was funded by Teva Pharmaceuticals.

EPR2076

Resting State Functional Connectivity Changes of the Hypothalamus in Migraine Patients: A Cross-Sectional and Longitudinal Study

R. Messina¹, M.A. Rocca¹, P. Valsasina², P. Misci², M. Filippi¹

¹Neuroimaging Research Unit, Institute of Experimental Neurology, Division of Neuroscience; and Neurology Unit, IRCCS San Raffaele Scientific Institute, Milan, Italy,

²Neuroimaging Research Unit, Institute of Experimental Neurology, Division of Neuroscience, IRCCS San Raffaele Scientific Institute, Milan, Italy

Background and aims: Previous studies support the role of the hypothalamus in migraine pathophysiology. The aim of our study was to explore cross-sectional and longitudinal resting state functional connectivity (RS FC) changes of the hypothalamus in patients with migraine.

Methods: Using a 3.0 Tesla scanner, RS functional magnetic resonance imaging (MRI) and 3D T1-weighted scans were acquired from 92 headache-free episodic migraine patients and 73 controls. 23 migraineurs and 23 controls were reexamined after 4 years. RS FC analysis was performed using a seed-region correlation approach and SPM12.

Results: At baseline, compared to controls, migraineurs showed a decreased RS FC between the left and right hypothalamus and the right cerebellum, frontal, temporal and occipital areas, bilaterally. At baseline, the decreased RS FC between the right hypothalamus and the ipsilateral lingual gyrus correlated with higher migraine attack frequency. After 4 years, migraine patients developed an increased RS FC between the hypothalamus and the orbitofrontal cortex, bilaterally, while RS FC between the right hypothalamus and the ipsilateral lingual gyrus decreased. RS FC between the right hypothalamus and the ipsilateral orbitofrontal cortex correlated with lower migraine attack frequency at year 4.

Conclusion: The hypothalamus modulates the activity of pain and visual processing areas in migraine patients. The recurrent experience of migraine attacks might disrupt the functional interaction between the hypothalamus and high-order visual processing areas. An increased RS FC between the hypothalamus and brain areas belonging to the descending pain-inhibitory pathway might reduce migraine attack frequency over time.

Disclosure: Nothing to disclose

EPR2077

Efficacy of Fremanezumab Treatment in Patients ≥ 60 Years of Age With Episodic or Chronic Migraine: Pooled Results of 3 Randomised, Double-blind, Placebo-controlled Phase 3 Studies

S.J. Nahas¹, X. Ning², J.M. Cohen², R. Yang², V. Ramirez-Campos², S.D. Silberstein¹

¹Department of Neurology, Thomas Jefferson University, Jefferson Headache Center, Philadelphia, PA, USA, ²Teva Branded Pharmaceutical Products R&D, Inc., West Chester, PA, USA

Background and aims: Preventive treatment of migraine may be challenging in older patients as some preventive medications may cause cognitive or cardiac side effects in this population. Fremanezumab, a fully-humanised monoclonal antibody (IgG2 Δ a) that selectively targets calcitonin gene-related peptide, has proven efficacy for preventive treatment of migraine in adults. Efficacy of fremanezumab was evaluated in a subgroup of patients ≥ 60 years of age in this pooled analysis.

Methods: This analysis in patients ≥ 60 years of age with episodic migraine (EM) or chronic migraine (CM) included data from 3 phase 3 trials (HALO EM, HALO CM, and FOCUS), in which patients were randomised 1:1:1 to subcutaneous quarterly or monthly fremanezumab or matched monthly placebo over 12 weeks. Changes from baseline in monthly migraine days, headache days of at least moderate severity, and days with acute headache medication use, as well as the proportion of patients achieving $\geq 50\%$ reduction in monthly migraine days, were evaluated over 12 weeks.

Results: Overall, 246 patients ≥ 60 years of age were included in these analyses. Reductions from baseline in monthly migraine days, headache days of at least moderate severity, and days with acute headache medication use over 12 weeks were significantly greater with quarterly and monthly fremanezumab versus placebo (all $P \leq 0.0103$; Table). The proportion of patients achieving $\geq 50\%$ reduction in monthly migraine days was significantly greater in patients receiving monthly fremanezumab versus placebo ($P = 0.0372$; Table).

Conclusion: This pooled analysis demonstrates that fremanezumab treatment was efficacious over 12 weeks in patients ≥ 60 years of age with EM or CM.

Disclosure: This study was funded by Teva Pharmaceuticals.

Table. Efficacy in Patients ≥ 60 Years of Age During 12 Weeks of Double-blind Treatment

	Placebo (n=80)	Quarterly fremanezumab (n=74)	Monthly fremanezumab (n=92)
Change from BL in monthly average number of migraine days			
LSM (SE)	-2.3 (0.57)	-4.3 (0.59)	-4.6 (0.54)
LSMD (SE) change from baseline	—	-2.0 (0.74)	-2.3 (0.70)
P value	—	0.0073	0.0011
Change from BL in monthly average number of days headache days of at least moderate severity			
LSM (SE) change from baseline	-2.1 (0.53)	-3.9 (0.55)	-4.2 (0.51)
LSMD (SE) change from baseline	—	-1.8 (0.69)	-2.1 (0.65)
P value	—	0.0103	0.0012
Change from BL in monthly average number of days of acute headache medication use			
LSM (SE)	-1.3 (0.55)	-3.7 (0.56)	-4.0 (0.52)
LSMD (SE) versus placebo	—	-2.4 (0.71)	-2.6 (0.66)
P value	—	0.0009	0.0001
$\geq 50\%$ reduction from BL in monthly average number of migraine days	=		
n (%)	20 (25)	27 (36)	37 (40)
OR (95% CI)	—	1.74 (0.87, 3.48)	2.01 (1.04, 3.88)
P value	—	0.1200	0.0372

BL, baseline; LSM, least-squares mean; SE, standard error; OR, odds ratio; CI, confidence interval.

EPR2078

SLEEP, PAIN, AND MIGRAINE: A blinded crossover study of experimental pain after sleep restriction

J.P. Neverdahl¹, J.O. Hansen¹, P.M. Omland², M. Uglem², D. Matre³, G.B. Gravdahl⁴, T. Sand²

¹Department of Neuromedicine and Movement Science (INB), NTNU, Trondheim, Norway, ²Department of neurology and clinical neurophysiology, Department of Neuromedicine and Movement Science (INB), St. Olavs Hospital, NTNU, Trondheim, Norway, ³AFP, STAMI, Oslo, Norway, ⁴Norwegian Advisory Unit on Headaches, Department of Neuromedicine and Movement Science (INB), St. Olavs Hospital, NTNU, Trondheim, Norway

Background and aims: There is an obvious link between insufficient sleep and migraine. Our objective was to explore whether sleep restriction increases pain perception more in episodic migraine than in headache-free controls. To our knowledge, this is the first study comparing the effect of sleep restriction on pain perception between migraineurs and controls.

Methods: Heat detection (HDT), heat pain (HPT), and heat pain tolerance (HPTT) thresholds were measured in interictal migraineurs and headache-free controls after 2 consecutive nights of habitual sleep (HS), and after 2 consecutive nights of partial sleep restriction (SR) (4 hours per night). 20 migraineurs (9 with aura, 15 females) and 29 controls (22 females) were included in the analyses. Investigators were blinded for diagnosis and sleep condition during recording and analysis of data.

Results: We did not find any significant between-group differences in effect of SR on thermal thresholds ($p=0.64$ for HDT, $p=0.59$ for HPT, $p=0.79$ for HPTT). HPT in migraineurs was $39.3^{\circ}\text{C}\pm 2.9$ after HS, 38.6 ± 2.8 after SR, and in controls 39.3 ± 3.1 after HS, and 39.2 ± 2.3 after SR. Notably, HPT was 0.7°C lower after SR in the migraine subgroup, although non-significantly ($p=0.41$).

Conclusion: Our hypothesis, that sleep restriction would increase pain sensitivity in episodic migraine more than in controls, was not confirmed in this study. Sleep restriction does not seem to have a large effect on experimental thermal pain thresholds in the interictal phase. More sensitive pain measures, increased sleep restriction, specific sleep-stage disruption, or larger groups may be necessary to further explore the hypothesis.

Disclosure: The research is funded by the Faculty of Medicine and Health Sciences, Norwegian University of Science and Technology, NTNU

EPR2079

Reversible cerebral vasoconstriction syndrome: triggers and minor brachiocephalic vascular abnormalities

M. Osipova, V. Goldobin, E. Klocheva
Neurology, NWSMU n.a. I.I. Mechnikov, StPetersburg, Russian Federation

Background and aims: Reversible cerebral vasoconstriction syndrome (RCVS) manifests by thunderclap headache with focal/universal cerebral symptoms and multiple segmental spasm of cerebral arteries which resolves within 3 months. Aim of study was to reveal main triggers, minor brachiocephalic vascular abnormalities (MBVA) in patients with RCVS

Methods: 172 patients with verified RCVS were examined (age 37.3 ± 11.3 years, women 133, men 39, $p<0.001$). Detailed neurological examination, brain MRI (1.5T/3T), MR arteriography and MR venography were performed in patients

Results: Primary RCVS was detected in 66 (38.4%) patients: 18 men and 48 women. Main triggers were: stress in 13 men and 39 women, physical or sexual activity in 8 men and 10 women. 2ndary RCVS was in 106 patients (61.6%): 18 men and 88 women, provoked by sympathomimetics (nasal spray) 9 men and 15 women; oral contraceptives in 45 women, alcohol consumption in 2 men and 9 women, cannabis in 3 men; paroxetine (2 men, 4 women) and triptan (3 women) administration. MBVA were revealed in 126 patients: vertebral artery hypoplasia: 68 women and 16 men, absence of posterior communicating arteries: 28 women and 7 men, anterior cerebral artery asymmetry: 12 women and 3 men, internal carotid artery trifurcation: 27 female, 6 males; venous sinus asymmetry: 36 women and 8 men

Conclusion: RSVS was more often in women comparing with men. Patients with RCVS had minor brachiocephalic artery abnormalities in 73.3% and venous sinus asymmetry in 25.6%. No significant difference in triggers in patients with primary and secondary RCVS was revealed.

Disclosure: Nothing to disclose

EPR2080

Effect of circadian phase on the discomfort and post injection complaints in preventive onabotulinumtoxin A injections for migrainesA. Packard¹, C. Smotherman²¹Neurology, University of Florida, Jacksonville, USA,²CHEQR, University of Florida, Jacksonville, USA

Background and aims: Determine circadian timing of the quarterly onabotulinumtoxin A (TBA) injections for chronic daily headaches/migraines associated with the lowest discomfort and minimal follow-up pain.

Methods: 61 patients receiving their initial TBA injection for migraine prevention were enrolled in the study and randomly assigned to morning or afternoon clinics. Patients self-reported level of discomfort prior to TBA injections by marking discomfort level on 100mm visual analog pain scale, VAPS. 155 units of BTA was administered by following the standardized PREEMPT injection protocol and the post-injection discomfort level was marked by the patient on the VAPS. The final patients' discomfort level was marked on the same VAPS 24-hours after TBA administration. Groups of morning versus afternoon patients were compared using the non-parametric Wilcoxon's Rank Sum Tests.

Results: 62% patients were injected during morning clinic and 38% were injected during afternoon clinic. There was no difference in gender, race and age variables between morning and afternoon patients. Increased in-pain was more frequent following the morning injections compared to the afternoon injections (78% vs 50%, $p=0.021$). 24 hour post-injection pain level was also significantly increased in patients that received morning injections compared to the afternoon injections (64% vs. 28%, $p=0.024$).

Conclusion: Performing TBA injections for migraine prevention during the morning clinic was associated with more treatment related discomfort both immediately following, as well as 24 hours after the injection. Scheduling patients with regular circadian rhythm for afternoon TBA injections might be beneficial in terms of decreasing treatment related discomfort and increasing therapeutic compliance.

Disclosure: Nothing to disclose

EPR2081

Patient-Reported Outcomes in Patients with Migraine and Prior Prophylactic Treatment Failure: A Subgroup Analysis from the BECOME StudyP. Pozo-Rosich¹, C. Lucas², C. Gaul³, D. Watson⁴,P. Martelletti⁵, S. Ritter⁶, J. Snellman⁷¹Headache Unit, and Headache and Neurological Pain Research Group, Vall d'Hebron University Hospital, andUniversitat Autònoma de Barcelona, Barcelona, Spain, ²Pain Clinic, Service de Neurochirurgie, Hôpital Salengro, CHRU de Lille, Lille Cedex, France, ³Migraine and HeadacheClinic Königstein, Königstein im Taunus, Germany, ⁴Hamilton Medical Group, Aberdeen, Scotland, UnitedKingdom, ⁵Department of Clinical and Molecular Medicine, Sapienza University of Rome, Sant'Andrea Hospital, Via diGrottarossa, Rome, Italy, ⁶Novartis Pharmaceuticals Corporation, East Hanover, NJ, USA, ⁷Novartis Pharma AG,

Basel, Switzerland

Background and aims: In this subgroup analysis from the BECOME study, we report the patient-reported outcomes (PROs) in patients with migraine and prior prophylactic treatment failure (PPTF 1, 2, 3, ≥ 4 medication categories) due to lack of efficacy and/or poor tolerability.

Methods: The BECOME study assessed disease characteristics of all patients with migraine visiting headache specialist centres (Part 1), and burden of disease using PROs and healthcare resource utilisation questionnaires in patients with ≥ 1 PPTF and ≥ 4 monthly migraine days (Part 2). Here, we assessed the impact of migraine on a patient's ability to work and perform regular activities using Work Productivity and Activity Impairment-headache (WPAI-headache), on general anxiety and depression using Hospital Anxiety and Depression Scale (HADS), and on daily functioning using the Migraine-Specific Quality of life (MSQ) questionnaire.

Results: Overall, 2419 patients were included in Part 2 analysis. The WPAI-headache scores indicated a high level of impairment due to migraine on absenteeism (15.6%), presenteeism (48.6%), and overall work impairment (52.6%) domains (Table). HADS scores indicated a possible presence of anxiety associated with migraine (mean[95%CI]: 8.0[7.8,8.2]). Migraine substantially limited and restricted patients' social and work-related activities (MSQ-RFR score 43.8[43.0,44.6]), and affected their emotional function (MSQ-EF: 50.5[49.4,51.6]). The burden of disease generally increased with higher PPTF, indicating a more difficult-to-treat population (except for HADS scores in ≥ 4 PPTF subgroup).

Conclusion: This subgroup analysis of the BECOME study confirms the burden of migraine on work productivity, anxiety, and quality of life in migraine patients, and an incremental increase with the number of PPTFs.

Table. PRO scores of the BECOME study population set for Part 2 (N=2419) by number of PPTF

	All N=2419 n=1587	1 PPTF N=1034 n=682	2 PPTF N=690 n=462	3 PPTF N=324 n=206	≥4 PPTF N=371 n=237
WPAI percent work time missed	15.6 (14.3, 16.9)	14.7 (12.7, 16.6)	15.0 (12.6, 17.4)	16.3 (12.5, 20.1)	18.8 (15.1, 22.4)
WPAI percent impairment while working	48.6 (47.2, 49.9)	47.1 (45.0, 49.2)	46.7 (44.1, 49.3)	52.8 (49.3, 56.3)	52.9 (49.6, 56.1)
WPAI percent overall work impairment	52.6 (51.2, 54.0)	50.7 (48.5, 52.9)	50.9 (48.2, 53.6)	56.5 (52.8, 60.1)	58.0 (54.6, 61.4)
WPAI Percent activity impairment	56.4 (55.3, 57.4)	53.6 (51.9, 55.3)	55.5 (53.4, 57.5)	60.7 (58.0, 63.5)	61.9 (59.4, 64.4)
HADS overall score	14.6 (14.3, 15.0)	14.3 (13.8, 14.8)	14.7 (14.1, 15.3)	15.5 (14.6, 16.4)	14.8 (13.9, 15.6)
HADS anxiety score	8.0 (7.8, 8.2)	7.9 (7.6, 8.2)	8.1 (7.8, 8.5)	8.2 (7.6, 8.7)	7.8 (7.4, 8.3)
HADS depression score	6.7 (6.5, 6.8)	6.4 (6.1, 6.7)	6.6 (6.2, 6.9)	7.3 (6.9, 7.8)	6.9 (6.5, 7.4)
MSQ-RFR score	43.8 (43.0, 44.6)	46.7 (45.4, 48.0)	44.8 (43.3, 46.3)	39.1 (37.0, 41.2)	38.1 (36.1, 40.1)
MSQ-RFP score	59.2 (58.2, 60.1)	61.7 (60.3, 63.1)	59.9 (58.2, 61.7)	55.7 (53.2, 58.2)	53.8 (51.4, 56.2)
MSQ-EF score	50.5 (49.4, 51.6)	54.2 (52.5, 55.8)	50.0 (48.0, 52.1)	46.9 (44.1, 49.8)	44.0 (41.2, 46.8)

All values are mean (95% CI), unless otherwise indicated
 CIs were calculated using Wald formula/method
 CI, confidence intervals; EF, emotional function; HADS, hospital anxiety and depression; HIT-6, headache impact test; HRCoL, health-related quality of life; mMIDAS, modified migraine disability assessment; MSQ, migraine specific quality-of-life; N, total number of patients in Part 2 or PPTF subgroups; n, number of patients responding to the respective questionnaire; PPTF, prior prophylactic treatment failures);
 PRO, patient-reported outcomes; RFR, role function restrictive; RFP, role function preventive; WPAI, work productivity and activity index
 WPAI scores range between 0 and 100, where higher scores indicate greater impairment
 MSQ scores range between 0 and 100, where higher scores indicate better HRCoL
 HADS scores range between 0 and 21, where higher scores indicate more severe distress
 Note: Data for the PRO measures including HIT-6 and mMIDAS were previously reported

PRO scores of the BECOME study population set for Part 2 (N=2419) by number of PPTF

Disclosure: This study was funded by Novartis Pharma AG, Basel, Switzerland. Erenumab is co-developed by Amgen and Novartis. A detailed disclosure from each author will be included in the e-poster presentation.

EPR2082

Treatment with Onabotulinumtoxin A versus Erenumab for Patients with Acquired/Post-traumatic Chronic Migraine

J. Rothrock

Neurology, George Washington University, Washington, MD, USA

Background and aims: Traumatic brain injury frequently is complicated by chronic headache which often has features of chronic migraine. We currently lack any evidence-based prophylactic therapy for chronic posttraumatic headache. In this study we assessed the relative efficacy, safety and tolerability of onabotulinumtoxinA versus erenumab for headache prophylaxis in patients with acquired/post-traumatic chronic migraine.

Methods: We randomized patients with chronic post-traumatic headache of at least 6 months duration and possessing the clinical phenotype of chronic migraine to treatment with open-label onabotulinumtoxin A versus erenumab. We evaluated the safety, tolerability and efficacy of each treatment, defining efficacy as a 50% or greater decline in monthly headache frequency at month 6 of treatment relative to the pre-treatment baseline month.

Results: We treated 172 patients (onabotulinumtoxin A n=87; erenumab n=85). There were no significant adverse events, and no patient discontinued treatment consequent to lack of tolerability. More patients achieved the primary treatment endpoint in the erenumab group (43/83: 52%) than in the onabotulinumtoxin A group (37/84: 44%), but the difference did not reach statistical significance.

Conclusion: Both onabotulinumtoxin A and erenumab appear to be safe and well-tolerated treatments for acquired/posttraumatic chronic migraine, and with either treatment over a period of 6 months approximately half of patients will experience a meaningful reduction in monthly headache frequency.

Disclosure: Consultant and speakers bureau: Amgen, Allergan My parent institution has received revenue from Amgen and Allergan for research I have performed. Amgen and Allergan advertise in and so provide revenue for a healthcare magazine (Migraineur) for which I serve as editor-in-chief.

EPR2083

Impact of an Employer-Provided Migraine Coaching Program on Patient Burden and Engagement

L. Schaetz¹, T. Rimmer², P. Pathak³, J. Fang⁴, F. Cadiou⁵, D. Chandrasekhar⁵, L. Vandervoort⁶, J. Mueller⁷, A. Gantenbein⁸

¹GPA, Novartis Pharma AG, Basel, Switzerland, ²Medgate, Basel, Switzerland, ³Novartis Ireland Limited, Dublin, Ireland, ⁴Novartis Pharma US, East Hanover, USA, ⁵Healint Pte. Ltd, Singapore, Singapore, ⁶Healint Pte Ltd., Singapore, Singapore, ⁷Novartis Pharma AG, Basel, Switzerland, ⁸Bad Zurzach, Switzerland

Background and aims: This retrospective study assessed the impact of a migraine telemedicine coaching program offered by a healthcare company as a complimentary service within its corporate health management program for its Swiss-based employees and their family members.

Methods: Of 339 participants who registered for the program from June 2018 until October 2019, 141 enrolled into a study for retrospective analysis of their data. All participants received six monthly sessions of individualized telecoaching comprised of educational modules and action plans from a specialized nurse by phone and through a specially developed module on the Migraine Buddy smartphone application. The study participants were evaluated through a series of questionnaires including Migraine Disability Assessment (MIDAS), Patient Activation Measure (PAM), and the commonly used coaching lessons and implemented action plans.

Results: Seventy-nine participants completed the program at 6 months. The mean age (standard deviation, SD) at baseline was 41.5 (8.8) years with 70.0% females, 64.1% had a confirmed diagnosis of migraine, and 56.8% were not being treated by a physician despite 74.0% having MIDAS grade ≥ 2 . The total mean (SD) MIDAS score and the PAM score significantly improved from baseline to 6 months (table). The most used coaching lessons focused on progressive muscle relaxation, sleep, general disease understanding, stress management, and nutrition while top action plans addressed sleep, hydration, nutrition, disease understanding and daily routine.

Parameter	# of Patients who completed baseline and 6 months assessments	Mean (SD)	P-value
MIDAS	73	Baseline= 15.0 (13.6) At 6 months= 6.9 (8.2) Change from baseline= -8.1 (5.5)	<.001
PAM	78	Baseline= 63.8 (10.9) At 6 months= 69.6 (12.8) Change from baseline= 5.8 (1.9)	.003

MIDAS and PAM scores

Conclusion: The results demonstrate that an employer-sponsored educational and counseling support that empower to leverage all options, medical & lifestyle, can significantly decrease migraine-related disability and promote disease management among employees.

Disclosure: This study was funded by Novartis Pharma AG.

EPR2084

Erenumab in real life: a multicentric italian observational study

R. Rao¹, F. Schiano Di Cola¹, S. Caratozzolo¹, E. Venturelli², U. Balducci³, V. Sidoti³, E. Pari⁴, L. Vinciguerra⁴, A. Di Summa⁵, G.J. Sixt⁵, E. D'adda⁶, P. Liberini¹, A. Padovani¹

¹Università degli studi di Brescia - ASST Spedali Civili di Brescia, Brescia, Italy, ²ASST Papa Giovanni XXIII, Bergamo, Italy, ³ASST Franciacorta, Chiari, Italy, ⁴ASST Cremona, Cremona, Italy, ⁵Azienda Sanitaria dell'Alto Adige, Bozen, Italy, ⁶ASST Crema, Crema, Italy

Background and aims: Erenumab is a monoclonal antibody targeting the calcitonin gene-related peptide receptor. Randomized, placebo-controlled trials demonstrated that erenumab is effective in the prevention of Episodic (EM) and Chronic Migraine (CM). However, real life clinical evidence is still missing.

Methods: An observational multicentre study was designed. Patients were treated with erenumab 70mg every four weeks. If no clinical response was observed after 12 weeks, a dose increase to 140mg was attempted. Data about outcome, adverse events, abortive medication consumption and disability (Migraine Disability Assessment Score Questionnaire – MIDAS; Headache Impact Test – HIT-6) were collected.

Results: 108 consecutive patients were enrolled (22 EM; 86 CM). Baseline clinical and demographic characteristics are shown in Table 1. A significant reduction from baseline to week 4, 12, 24 and 36 in headache days, analgesics consumption, pain intensity (numerical rating scale) and MIDAS score per month was found (Table 2). The percentage of non-responders (<30% headache days reduction), partial-responders (<50%), responders (>50%) and super-responders (>75%) at week 4, 12, 24 and 36 is shown in Figure 1. When analysing data from non responders and partial responders at week 12, a significant reduction from baseline in analgesics consumption (p=0.001), pain intensity (p=0.001) and MIDAS (p<0.0001) was found.

Table 1: subjects baseline demographic and clinical features.

	SUBJECTS (n=108)
AGE, years (mean, SD)	47.15 (9.5)
FEMALE, number (%)	83 (76.9%)
DISEASE DURATION, years (mean, SD)	27.9 (9.8)
PREVIOUS PROPHYLAXIS, number (mean, SD)	5 (1.08)
ADD-ON PROPHYLAXIS, number (%)	44 (40.7%)
MEDICATION OVERUSE, number (%)	84 (77.8%)

Table 1: subjects baseline demographic and clinical features.

Table 2: between-subjects ANOVA results documenting a statistically significant reduction in headache days, analgesics consumption, pain intensity and disability.

	BASELINE	WEEK 4	WEEK 12	WEEK 24	WEEK 36	p
TOTAL HEADACHE DAYS/MONTH	21.0 (1.2)	12.0 (1.6)	10.8 (1.5)	8.8 (1.3)	8.4 (1.3)	<0.001
Mean (SD)						
MILD HEADACHE DAYS/MONTH	11.6 (1.4)	6.9 (1.1)	7.0 (1.3)	6.6 (1.0)	3.9 (0.6)	=0.02
Mean (SD)						
SEVERE HEADACHE DAYS/MONTH	9.3 (1.3)	5.0 (0.8)	3.9 (1.0)	2.0 (0.6)	3.6 (0.7)	=0.001
Mean (SD)						
TOTAL ANALGESICS/MONTH	22.4 (2.7)	10.3 (1.4)	9.0 (1.3)	6.8 (0.9)	8.0 (1.0)	=0.002
Mean (SD)						
NSAIDS/MONTH	11.6 (3.2)	3.7 (0.9)	3.8 (1.3)	2.7 (0.8)	2.1 (0.7)	=0.02
Mean (SD)						
TRIPTANS/MONTH	11.2 (1.9)	6.5 (1.2)	5.3 (1.1)	3.9 (0.8)	5.5 (0.9)	=0.03
Mean (SD)						
NRS	7.4 (0.2)	5.6 (0.3)	5.1 (0.3)	4.9 (0.3)	4.9 (0.3)	=0.001
Mean (SD)						
MIDAS	76.0 (9.7)	N/A	28.0 (6.1)	23.8 (5.4)	N/A	=0.001
Mean (SD)						
HIT-6	62.3 (1.8)	N/A	54.6 (1.4)	52.4 (1.6)	N/A	=0.009
Mean (SD)						

Abbreviations: SD: standard deviation; NSAIDs: Nonsteroidal anti-inflammatory drugs; NRS: numerical rating scale; MIDAS: Migraine Disability Assessment Score Questionnaire; HIT-6: Headache Impact Test; N/A: not available.

Table 2: between-subjects ANOVA results documenting a statistically significant reduction in headache days, analgesics consumption, pain intensity and disability.

Figure 1: responders rates at week 4, 12, 24 and 36 of treatment.

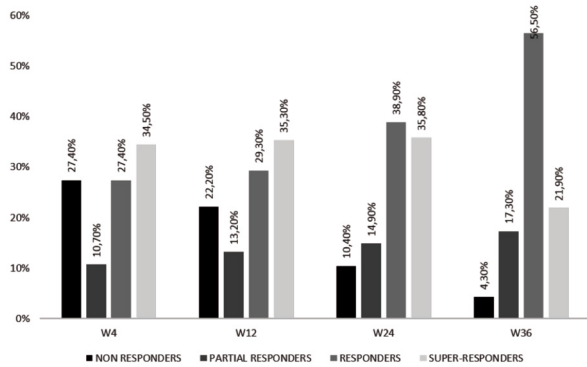

Figure 1: responders rates at week 4, 12, 24 and 36 of treatment.

Conclusion: The data confirm erenumab efficacy in migraine prophylaxis. Over 70% of patients documented a significant progressive and sustained improvement, from week 4 to week 36, in headache days, analgesics consumption, pain intensity and migraine related disability.

Disclosure: Nothing to disclose

Infectious diseases 1

EPR2085

Tuberculoma simulates a brain neoplasm in an immunocompetent patient: a diagnostic challenge

J.D.P. Castellano Santana, A. Diaz Diaz,
L.M. Pérez Navarro, I. Sánchez-Miranda Román,
R. Jiménez Bolaños

Neurology, Complejo Hospitalario Universitario Insular Materno-Infantil, Las Palmas de Gran Canaria, Spain

Background and aims: Tuberculoma is a granulomatous inflammatory process that can simulate a malignant tumor in the brain. This entity is uncommon even more in immunocompetent patients. Our goal is to present a clinical case of cerebral tuberculoma resembling a brain tumor.

Methods: We present a 44-year-old man from Mauritania. He had mild oppressive fronto-temporal headache associated with vertiginous sensation and unsteady gait for a month. The magnetic resonance showed an isolated expansive ring-enhancing lesion in left cerebellar hemisphere with perilesional edema. The cerebrospinal fluid was normal. This patient developed clinical deterioration requiring external ventricular shunt and subsequent surgical intervention by craniotomy and total excision. The histopathological diagnosis was tuberculoma and screening showed indeterminate bilateral pulmonary millimeter nodules only. No immunodeficiencies were observed.

Results: Mycobacterium tuberculosis usually spreads hematogenously from a primary pulmonary infection. It can produce subpial, subependymal or borderline gray/white foci in the brain. Exceptionally, these foci can grow without breaking into the subarachnoid space and develop tuberculomas without meningeal involvement. This presentation is uncommon in immunocompetent patients.

Conclusion: Tuberculoma should be included in the differential diagnosis of an expansive isolated cerebral lesion. Epidemiological history is important even in immunocompetent patients.

Disclosure: Nothing to disclose

EPR2086

Listerial abscesses, the key is in the blood

A. Celdrán de Castro García¹, R. Sainz Amo¹,
A. Saez Marin¹, Á. Beltrán Corbellini², J. Gómez Corral¹,
O. Fedirchuk³, B. Baena Álvarez¹, N. García Barragán¹,
F.J. Buisan Catevilla¹

¹Neurology, Hospital Ramon y Cajal, Madrid, Spain,

²Madrid, Spain, ³Neurophysiology, Hospital Ramon y Cajal, Madrid, Spain

Background and aims: *Listeria monocytogenes* (LM) is a cause of CNS infection, especially in immunocompromised population. The most common manifestation is meningoencephalitis -typically- rhombencephalitis, whereas cerebral abscesses are exceptional. We present one case and a literature review from 1968 to 2019.

Methods: Study case and systematic literature review

Results: A 77-year-old woman, under treatment with methotrexate and corticosteroids by polymyalgia rheumatica, presents at emergency department due to fever, disorientation and aphasia. She had consumed homemade goat cheese in the last month. Lumbar puncture demonstrated lymphocytic pleiocytosis. Only blood cultures were positive for LM. MRI showed a left frontal abscess. After 6 weeks of treatment with ampicillin, she was discharged, without sequelae, and neuroimaging improvement. There are 80 cases described in the literature, with a mortality rate about 20%. Despite LM is an opportunistic agent, in 25.3% of cases there was not any predisposing condition. As in our case, in 79.3% of cases the blood cultures were positive for LM, compared to 40.3% in CSF. The most common location was lobar (53.5%), followed by basal ganglia (21%) brainstem location (19%). In 21% of cases, multiple abscesses were found, half of them occurring in immunosuppressed patients.

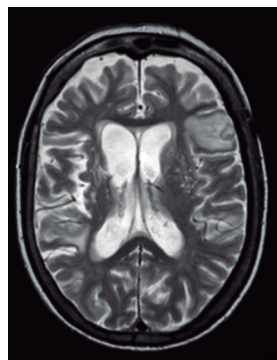

T2 sequence showing left frontal abscess

Conclusion: The spread to central nervous system of LM, including abscesses is a rare condition, associated in most cases with immunosuppression. Due to the hematogenous dissemination of LM, blood cultures have a higher diagnostic profitability compared to CSF culture, being able to avoid brain biopsy

Disclosure: Nothing to disclose

EPR2087

Neurological presentations of HIV infection: a retrospective observational study in Hong Kong

C.H. Cheung, B. Sheng, Y.P. Chu, W.T. Wong, H.H. Kwan, L.P. Ng, Y.L.T. Lam

Department of Medicine and Geriatrics, Princess Margaret Hospital, Hong Kong, Hong Kong (SAR of China)

Background and aims: Human immunodeficiency virus (HIV) infection can present in various ways, and the nervous system is frequently involved. The prevalence of neurological presentations of HIV in our locality is unknown.

Methods: This is a retrospective observational study that included adult HIV patients admitted to Princess Margaret Hospital (1 of the 2 hospitals with HIV specialist care in Hong Kong) during January to December 2018. Data including demographics, past history, initial presentation, neurological diagnoses, etc. were analysed.

Results: 113 HIV patients were identified (male 81%, with 52% men having sex with men; mean age at diagnosis 42, range 20-86). 19 patients presented with neurological conditions, most commonly cryptococcal meningitis (32%), followed by tuberculous meningitis (21%), cerebral toxoplasmosis and varicella zoster virus meningoencephalitis (both 16%). 1 patient presented with bilateral Bell's palsy as a manifestation of acute retroviral syndrome. On the other hand, 5 patients developed neurological conditions after commencement of antiretroviral therapy (ART) - progressive multifocal leucoencephalopathy in 2, cerebral toxoplasmosis in 2, and epidural mass in spinal cord due to tuberculosis in 1. They were either due to unmasking immune reconstitution inflammatory syndrome, or poor adherence to ART. At 1 year follow-up, majority survived with good outcomes.

Conclusion: The prevalence of neurological conditions among HIV patients in our cohort is 21% (17% as the initial presentation). This is not as frequent compared to less developed areas like India (26%) and sub-Saharan Africa (45%).

Disclosure: Nothing to disclose

EPR2088

Neurosyphilis: clinical and socio-demographic profile in a tertiary hospital in Madrid

S. De la Fuente Batista¹, A. Cabello Ubeda², J.L. Hernández Alfonso¹, I. Zamarbide Capdepón¹

¹Neurology, Hospital Universitario Fundación Jiménez Díaz, Madrid, Spain, ²Infectious Diseases, Fundación Jiménez Díaz, Madrid, Spain

Background and aims: Neurosyphilis is the clinical result of infection of the nervous system by *Treponema Pallidum* and can occur at any time after the initial infection.

It is uncommon now, as compared with the era before the introduction of penicillin, but there has been a resurgence of syphilis in low- and middle-income countries and in certain populations in developed countries.

We present a series of 33 patients with neurosyphilis, describing their clinical, serological, neuroimaging and socio-demographic characteristics.

Methods: Retrospective and descriptive study including all patients presenting to Neurology and Infectious Diseases departments with neurosyphilis between 2004 and 2019.

Results: We identified 33 patients with neurosyphilis. Mean age of onset was 50 years, 84% were males and 72% were Spanish. 45% presented a concomitant infection by human immunodeficiency virus. The most frequent forms were ocular syphilis (39%), followed by meningovascular syphilis (18%), and cognitive deterioration and neuropsychiatric alterations (12%). VDRL in cerebrospinal fluid was positive in 40% of patients. Most patients (93%) were treated with high dose IV penicillin G between 10 to 14 days, with partial or total improvement in 66%.

Conclusion: -Neurosyphilis is the result of infection of the nervous system by *Treponema Pallidum* and can occur at any time in the course of infection. It's incidence has increased over recent years.

- Diagnosis of neurosyphilis is based on clinical features, laboratory test and cerebrospinal fluid analysis.

-Neurosyphilis has undergone a very important clinical and epidemiological change in recent years, so clinical suspicion is essential for the diagnosis.

Disclosure: Nothing to disclose

EPR2089

Bacterial Meningitis Complicated by Cerebral Venous Thrombosis

S. Deliran¹, M.C. Brouwer¹, J. Coutinho²,
D. Van de Beek¹

¹Amsterdam, Netherlands, ²Department of Neurology,
Academic Medical Centre, Amsterdam, Netherlands

Background and aims: Cerebral venous thrombosis (CVT) has been described as an uncommon complication of community-acquired bacterial meningitis, but this has not systematically been studied.

Methods: We evaluated clinical characteristics and outcome of CVT in adults with community-acquired bacterial meningitis in a prospective nationwide cohort study of bacterial meningitis from 2006 to 2018 in the Netherlands.

Results: CVT occurred in 26 of 2565 episodes with bacterial meningitis (1%) in 26 patients. The diagnosis of CVT was made on presentation day in 15 patients (56%) and during admission in 11 patients after a median of 6 days (IQR 2-7). Sinusitis or otitis was present in 16 of 24 patients (67%). Patients with CVT presented more often in coma, as defined a score on the Glasgow Coma Scale <8, than those without CVT (53 vs. 18%; P=0.001) and the clinical course was more often complicated by focal neurologic deficits (58 vs. 22%; P<0.001). The transverse sinus was most frequently thrombosed (18 of 26; 69%) and Streptococcus pneumoniae was the most common causative pathogen, occurring in 17 of 26 patients (65%). Eleven patients (44%) received anticoagulant therapy with heparin and none of them developed intracerebral hemorrhage. Unfavorable outcome, as defined as a score on the Glasgow Outcome Scale <5, occurred in 14 of 26 patients (54%) and 4 patients (15%) died.

Conclusion: CVT is a rare complication of bacterial meningitis and is associated with coma, ENT infections, and focal neurologic deficits.

Disclosure: Nothing to disclose

EPR2090

Cerebrospinal fluid sex steroid hormone levels in pneumococcal meningitis

S. Dias, M.C. Brouwer, A. Boelen, D. Van de Beek
Amsterdam, Netherlands

Background and aims: Unfavourable outcome in bacterial meningitis is related to excessive inflammation and higher inflammatory markers have been reported in female than male patients. We investigated the association between cerebrospinal fluid (CSF) sex steroid hormone levels and outcome, disease severity and inflammatory parameters in pneumococcal meningitis.

Methods: We identified adults with culture-proven pneumococcal meningitis included in a prospective cohort study (2006-14). We measured oestradiol and testosterone in leftover CSF using liquid chromatography-tandem mass spectrometry and sex hormone-binding globulin (SHBG) using an enzyme-linked immunoassay. Outcome was graded using the Glasgow Outcome Scale score (5 indicating favourable, 1-4 unfavourable outcome).

Results: 60 patients were included: 20 males, 20 premenopausal (<50 years) and 20 postmenopausal (>50 years) women. Median age was 65, 38 and 70 years, respectively. 21 (35%) patients had an unfavourable outcome and 11 (18%) died. Median SHBG was 0.65nmol/L in men, 0.45 in premenopausal and 1.10 in postmenopausal women (p=0.52), while median testosterone was 0.24nmol/L, 0.05 and 0.13, respectively (p<0.001). Median oestradiol was 7.50pmol/L in males, 11.00 in premenopausal and 12.50 in postmenopausal females (p=0.27). Only SHBG differed between cases with favourable vs unfavourable outcome (1.00 vs 0.40, p=0.03). Oestradiol was positively correlated with C-reactive protein (rs=0.47, p=0.01) and erythrocyte sedimentation rate (rs=0.48, p=0.04), while testosterone was negatively correlated with the latter (rs=0.39, p=0.03). We found no correlation between hormone levels and illness severity (Dutch Meningitis Risk Score).

Conclusion: In this exploratory study, lower SHBG was associated with unfavourable outcome whereas oestradiol was positively and testosterone negatively correlated with serum inflammation parameters.

Disclosure: This study has been funded by a Research Grant (2018) of the European Society of Clinical Microbiology and Infectious Diseases and by a Research Training Fellowship (2019) of the European Academy of Neurology.

EPR2091

Causes, clinical presentation and outcome of Meningitis, Meningoencephalitis and Encephalitis cases in Switzerland, a retro- and prospective analysis of 258 patients

A. Ungureanu¹, G. Chiffi², L. Jaques¹, F. Suter-Riniker², S. Leib², C. Bassetti¹, A. Dietmann¹

¹*Department of Neurology, Inselspital, Bern University Hospital and University of Bern, Bern, Switzerland, ²Institute for Infectious Diseases, University of Bern, Switzerland*

Background and aims: We aimed to identify most frequent causes, clinical presentation and long-term outcome of acute cases of meningitis (M), meningoencephalitis (ME) and Encephalitis (E) treated in the Inselspital, University Hospital Bern, Switzerland.

Methods: We performed a retrospective review of clinical patient records for all patients treated in the Inselspital for the diagnosis of M/ME/E during the period of 1.1.2016 until 31.10.2018. Patients were contacted prospectively for a telephone follow-up interview and were asked to fill out and return questionnaires.

Results: We included 258 patients: 85 (33%) had M, 127 (49%) ME and 46 (18%) E. Most frequently infectious causes were identified: 48% in M and 40% in ME/E, with Enterovirus (39%) and tick borne virus (57%) being the most frequently identified infectious agent respectively. 7% of all ME/E cases were of autoimmune origine. In 43% of M and 32% of ME/E patients the etiology remained unknown. In a telephone interview, undertaken more than a year (Median 14/17 months respectively) after recovering from the acute disease, still 29% of M and 65% of ME/E patients reported persisting neurological sequelae such as headache (22%/28% resp.), memory problems (26%/29% resp.), cognitive deficits (17%/23% resp.) as well as epileptic seizures (28%) in ME/E amongst other signs and symptoms. 17% of M and 41% of ME/E patients indicated to suffer from excessive daytime sleepiness.

Conclusion: Long-term sequelae after M/E and also after M are found in a significant portion of survivors.

Disclosure: Nothing to disclose

Movement disorders 3

EPR2092

Fall risk assessment with in- and off-laboratory mobility measures in patients with neurological gait disorders – the PAss FaMous study

A. Huppert¹, M. Wuehr¹, J. Decker², K. Jahn², M. Dieterich¹, T. Brandt¹, R. Schniepp¹

¹German Center for Vertigo and Balance Disorders, Munich, Germany, ²Bad Aibling, Germany

Background and aims: Falls are frequent among patients with neurological gait disorders (Stolze et al., 2005). Besides the assessment of socio-demographic and clinical risk factors via questionnaires and clinical scoring systems, technical based movement quantification procedures have reached scientific impact in order to quantify gait stability and fall risk. The study examined the predictive power of in- and off-laboratory measures for fall prediction.

Methods: For the Prospective Assessment of Falls and Mobility–study (PAss FaMous-study, DRKS-ID: DRKS00007762) 396 patients were examined by a standardized fall risk assessment, in-laboratory-based gait analysis (GAITrite[®]), and an off-laboratory tracking of physical activity (ActivPal[®]). A follow-up of 6 months with prospective recordings of falls via fall calendar and telephone interview was established. After testing for possible differences via ANOVA models, binary logistic regression procedures for model I “fall status”, model II “fall frequency” and model III “fall severity” were performed.

Results: The regression model I showed a correct prediction in 82% of the cases, model II and model III in 88%. Significant factors were dependent on the underlying model. (Table 1)

Conclusion: For the identification of falls and high fall frequency, the assessment of the fall history in combination with dynamic stability parameters of the walking behavior appears to be useful. Mobility measures are relevant for the prediction of frequent falling and severe falling. Frequent falling shows associations to the daily intensity of locomotion. For the identification of severe falling, pattern parameters of physical activity are more important.

Disclosure: Nothing to disclose

	model information	parameter information						
	correct prediction	coefficient	SE	df	p-value	Exp(b)	low	high
Model I ,Fall status'	0.82							
retrospective fall status		1.46	0.27	1	0.001	4.296	2.528	7.299
MOCA		0.14	0.06	1	0.030	1.148	1.014	1.300
FGA		-0.10	0.05	1	0.045	0.901	0.815	0.997
gait velocity		-0.04	0.02	1	0.010	0.957	0.925	0.989
stride time		0.67	0.02	1	0.003	1.069	1.023	1.118
CV of stride time		0.47	0.15	1	0.001	1.607	1.203	2.146
phase synchronization index		-0.18	0.15	1	0.46	0.839	0.706	0.997
Model II ,frequent falls'	0.88							
retrospective fall status		1.61	0.35	1	0.001	5.024	2.510	10.058
MOCA		0.15	0.08	1	0.050	1.166	1.000	1.359
ABC-d		-0.03	0.01	1	0.007	0.971	0.950	0.992
SF-12		0.16	0.08	1	0.050	1.174	1.004	1.374
base of support		0.13	0.06	1	0.020	1.143	1.021	1.279
CV of stride time		0.53	0.18	1	0.002	1.704	1.207	2.405
phase synchronization index		-0.25	0.11	1	0.018	0.781	0.636	0.959
ambulatory bout #		-0.01	0.01	1	0.007	0.990	0.983	0.997
daily intensity		0.52	0.22	1	0.020	1.681	1.085	2.605
sedentary bout duration		-0.01	0.01	1	0.044	0.998	0.995	1.000
Model III ,severe falls'	0.88							
gait velocity		-0.03	0.01	1	0.012	0.969	0.945	0.993
ambulatory bout alpha		-23.45	1.45	1	0.024	0.100	0.002	0.121

EPR2093

Cancelled

EPR2094

Genetic screening for autosomal recessive genes and phenotypic features in young onset Parkinson's disease: A Greek Cohort.

C. Koros¹, H. Liu², A.M. Simitsi¹, A. Bougea¹, C. Schulte³, N. Papagiannakis¹, M. Maniati⁴, I. Pachi¹, S.G. Papageorgiou⁵, M. Bozi⁵, M. Stamelou¹, T. Gasser³, L. Stefanis¹

¹1st Neurology Clinic, Eginition Hospital, University of Athens, Athens, Greece, ²University of Tuebingen, Germany, Tuebingen, Germany, ³Department of Neurodegeneration, Hertie Institute for Clinical Brain Research, University of Tuebingen, Tuebingen, Germany., ⁴Center of Clinical Research, Experimental Surgery and Translational Research, Biomedical Research Foundation of the Academy of Athens, Athens, Greece, ⁵2nd Department of Neurology, Attikon Hospital, Medical School, National and Kapodistrian University of Athens, Athens, Greece

Background and aims: Young onset Parkinson's disease (PD) with onset ≤ 45 years old, has been associated with several causative genes. We aimed to determine the incidence of the most common autosomal recessive PD genes (PRKN, PINK1, DJ1) in a cohort of 68 unrelated young onset PD patients in Greece.

Methods: Assessment included Sanger Sequencing for PARK, PINK1, DJ1 genes, Multiplex ligation-dependent probe amplification (MLPA) for dosage PRKN mutations and Whole Exome Sequencing in selected cases.

Results: Pathogenic PRKN variants were identified in 5 cases (2 homozygous/ 3 compound heterozygous). Mean age at onset was 38, dystonia was reported in 5/5 and family history in 2/5 patients. Cognition was not affected, psychiatric problems were prominent, while hyposmia and REM sleep behavior disorder (RBD) were scarce. 2 patients were mutation carriers with likely pathogenic heterozygous PRKN mutations (exon 2 deletion and c.101_102del AG). Pathogenic PINK1 mutations, including a novel pathogenic mutation p.Y295X in a homozygous state, were found in 3 patients (2 homozygous / 1 compound heterozygous). The mean age at onset was 35.7, 1st symptom was rest tremor in 2/3 cases, and a positive family history was reported in 2/3 patients. Cognition was not severely affected, olfaction was intact, RBD was reported in 2/3 cases, insomnia in 3/3 and freezing of gait (2/3) was very pronounced in one patient.

Conclusion: Our genetic screen revealed a prevalence of common recessive PD genes in 14.7% of young onset PD cases, suggesting the existence of additional pathogenic variants besides those currently screened in clinical routine.

Disclosure: Nothing to disclose

EPR2095

DAT SPECT and MIBG myocardial scintigraphy imaging profiles and clinical stages in Parkinson's disease and dementia with Lewy Bodies.

Y. Kujuro¹, H. Hattori¹, K. Ohta²

¹Department of Neurology, Tachikawa Hospital, Tokyo, Japan, ²Department of Neurology, Ryokuseikai Hospital, Tokyo, Japan

Background and aims: DAT SPECT and MIBG are widely used tools in the diagnosis of Parkinson's disease (PD) and dementia with Lewy Bodies (DLB). This study aimed to reveal their correlation to Hoehn-Yahr (H-Y) stage and disease duration in PD and DLB.

Methods: The subjects were idiopathic 63 PD and 23 DLB patients who underwent DAT SCAN. Among these patients, 58 PD and 18 DLB patients also received MIBG. Specific binding ratio (SBR) and delayed heart-to-mediastinum (H/M) ratio were evaluated.

Results: SBR value was significantly reduced (cut off: 4.5) in 97% of the PD and 100% of the DLB patients, and H/M ratio was significantly reduced (cut off: 2.2) in 78% of the PD and 89% of the DLB patients. SBR value was significantly correlated with H-Y stage in both PD and DLB patients (PD: $R^2=0.072$, $p=0.033$, DLB: $R^2=0.34$, $p=0.0047$) but not with disease duration, which indicates that SBR value evaluates motor severity. H/M ratio was significantly correlated with H-Y stage and disease duration in PD patients (H-Y stage: $R^2=0.091$, $p=0.021$, duration: $R^2=0.13$, $p=0.0048$) whereas no correlation was observed between H/M ratio and these parameters in DLB patients. H/M ratio in H-Y 1 stage seemed to be lower (1.4 ± 0.2) in DLB patients compared to that of PD patients (2.2 ± 0.8).

Conclusion: DAT scan is suitable for evaluation of motor severity in both PD and DLB patients. Our preliminary result of MIBG may reflect that pathological changes in the cardiac sympathetic nerves are more profound in DLB patients compared to PD patients with early motor stage.

Disclosure: Nothing to disclose

EPR2096

The role of the cerebellum in cortical myoclonus: a neurophysiological study

A. Latorre¹, L. Rocchi¹, G. Paparella², A. Berardelli³, J. Rothwell¹, K. Bhatia¹

¹Department of Clinical and Movement Neurosciences, UCL Queen Square Institute of Neurology, University College London, London, United Kingdom, ²Rome, Italy, ³Neurology and Psychiatry - Neuromed Institute, Sapienza University of Rome, Rome, Italy

Background: The putative involvement of the cerebellum in the pathogenesis of CM syndromes has been long hypothesized, as pathological changes in patients with CM have commonly been found in the cerebellum rather than in the suspected culprit, the sensorimotor cortex. The hypothesis is that the increased cortical excitability seen in CM is due to loss of the cerebellar inhibitory control via cerebello-thalamo-cortical connections. Here, we explore this hypothesis by modulating cerebellar excitability by means of transcranial Direct Current Stimulation (tDCS), and assessing its effect on sensorimotor cortex excitability in patients with CM.

Methods: 7 patients with CM underwent the following neurophysiological tests: short intracortical inhibition (SICI), somatosensory evoked potentials (SEP) and long-latency reflexes (LLR), tested before and after anodal cerebellar tDCS applied on the cerebellum. Data were compared with those obtained in 7 healthy controls (HC).

Results: The amplitude of N20-P25 and P25-N33 components of SEP was increased in patients after tDCS, but not in HC. A similar trend was observed in LLR, with a significant increase in amplitude before and after tDCS in patients. Baseline SICI was reduced in patients compared to HC. Whereas tDCS caused a further SICI reduction in patients, it did not change SICI in HC.

Conclusion: According to our data, anodal cerebellar tDCS increases sensorimotor cortex excitability in CM. Overall, the present results suggest a role of the cerebellum in the pathophysiology of CM, and that CM patients might have abnormal homeostatic plasticity within the sensorimotor cortex, possibly responsible for this paradoxical response.

Disclosure: Nothing to disclose

EPR2097

Correlation of dopaminergic denervation and the progression of autonomic dysfunctions in different clinical subtypes of Parkinson's disease: Analysis of the PPMI data

H. Lee, E.H. Jeong, B.-S. Kim, H.-J. Yu, Y.K. Park, J. Seo, M.K. Sunwoo

Department of Neurology, Bundang Jesaeng General Hospital, Seongnam-si, Korea, Republic of

Background and aims: Autonomic dysfunctions occur in the early stage of Parkinson's disease (PD), and impacts the quality of life throughout the progression of the disease. In this study, we evaluated the serial progression of autonomic dysfunctions in different subtypes of a prospective PD cohort.

Methods: From the Parkinson's Progression Markers Initiative (PPMI) database, 325 PD patients (age 61.2 ± 9.7 , M:F = 215:110) were enrolled. Patients were subgrouped into tremor dominant (TD), indeterminate, and postural instability gait disorder (PIGD) subtypes. The progression of autonomic dysfunctions, and dopaminergic denervation from I-123 FP-CIT SPECT images of each group were analyzed and compared at baseline, 12 months, 24 months, and 48 months of follow up periods.

Results: The SCOPA-AUT score of the indeterminate group was significantly higher than that of the TD group ($P < 0.05$) at baseline, and was significantly higher than both TD and PIGD subtypes ($P < 0.05$) at 48 months. The indeterminate group had the most significant correlation between the aggravation of dopaminergic denervation in I-123 FP-CIT SPECT images, and the increase of SCOPA-AUT scores during 48 months of follow up ($r = 0.56$, $P < 0.01$).

Conclusion: Autonomic dysfunctions were most severe in the indeterminate subtype throughout the 48 months follow up period, with a significant correlation with dopaminergic denervation. The indeterminate subtype may present autonomic dysfunctions as the main symptom, and the severity of autonomic dysfunctions may be monitored with I-123 FP-CIT SPECT.

Disclosure: Nothing to disclose

EPR2098

Remote and frequent assessment of Huntington's disease in clinical trials: Strategies for assessing and accounting for the practice effect

A. Wolfer¹, F. Lipsmeier¹, R. Tortelli², F.B. Rodrigues², L.M. Byrne², C. Simillion¹, T. Kilchenmann¹, A. Bamdadian¹, S.A. Schobel³, E.J. Wild², M. Lindemann¹

¹Roche Pharmaceutical Research and Early Development, pRED Informatics, F. Hoffmann-La Roche Ltd, Basel, Switzerland, ²Huntington's disease Centre, UCL Queen Square Institute of Neurology, University College London, London, United Kingdom, ³F. Hoffmann-La Roche Ltd, Basel, Switzerland

Background and aims: Digital monitoring tools enable remote assessment of Huntington's disease (HD) signs and symptoms in patients' daily lives at a higher frequency than clinician-administered tests. Studies have shown that most gold-standard tests are influenced by practice effects; i.e. the improvement in performance resulting from the repetition of a task. During initial digital testing sessions, changes in performance may be confounded by test-taking strategies, difference in manual dexterity or test/device knowledge. It is key to distinguish between a subject's familiarisation period with the test, and subsequent longitudinal changes related to disease progression and continued practice to avoid confounding the interpretation of clinical results.

Methods: This study assessed the impact of task repetition on performance and established the number of practice test iterations required to accurately estimate true performance changes. 7 motor and cognitive smartphone-based assessments were completed daily or weekly by individuals with manifest HD ($n = 36$), premanifest HD ($n = 20$) and healthy controls ($n = 20$) in the Digital-HD Study. A 2-phase learning curve model characterised individual practice and longitudinal effects. Based on the model's estimation of familiarisation period duration and performance changes, the impact on each task and disease group performance was established.

Results: While subjects experienced practice effects for cognitive tasks, some motor tasks were free of such effects. When practice occurred, less than 10 test iterations were required for the subject to reach a stable test performance.

Conclusion: Practice effects can be characterised using high-frequency remote patient monitoring, and mitigation strategies implemented to facilitate accurate interpretation of clinical trial results.

Disclosure: Study sponsored by UCL and supported by F. Hoffmann-La Roche Ltd; the authors thank Sarah Child, of MediTech Media, for providing editorial support for this abstract.

EPR2099

Withdrawn

EPR2100

Analysis of mortality in patients with advanced Parkinson's disease treated with Deep Brain Stimulation of the Subthalamic Nucleus (STN-DBS).

M. Morales de la Prida¹, J. López Sánchez¹, M. Cánovas Iniesta¹, M.T. Alba Isasi¹, J. Vazquez Lorenzo¹, M.O. Caballero Lozano¹, V.M. Pérez Navarro¹, E. Gómez López², C. Perán Fernández³, L. Fuentes Rumí¹, G. Valero López¹, A.E. Báidez Guerrero⁴, E. García Molina¹, R. Carrasco Torres⁵, B. Cuartero Pérez⁶, M. Felipe Murcia⁶, J. Jimenez Veiga⁷, O. Morsi Hasan¹

¹Neurology, Virgen de la Arrixaca University Clinical Hospital, Murcia, Spain, ²Neurology, Reina Sofia University General Hospital, Murcia, Spain, ³Santa Lucía University General Hospital, Cartagena, Spain, ⁴Neurology, Elche University General Hospital, Elche, Spain, ⁵Neurology, Los Arcos del Mar Menor University Hospital, Murcia, Spain, ⁶Neurosurgery, Virgen de la Arrixaca University Clinical Hospital, Murcia, Spain, ⁷Neuropsychology, Virgen de la Arrixaca University Clinical Hospital, Murcia, Spain

Background and aims: STN-DBS in advanced Parkinson's disease (PD) has shown to improve the quality of life of patients and, in some studies, greater survival.

Methods: Clinical-demographic variables and causes of mortality of advanced PD patients treated with STN-DBS in our center are analyzed.

Results: 72 patients were recruited. 61,1% men. Mean age of diagnosis was 51.1 years with a median age at surgery of 65 years and a mean of 10 years from the diagnosis to the surgery.

18 patients have died, 12 (66.7%) men, without gender being an influencing factor in mortality. In those who died, the mean age of diagnosis was 56.5 years (SD 6.9) and the median age at surgery was 69 years (IQR 65-73), being this one significantly higher ($p=0.007$) than the median age at surgery in the living patients (62 years, IQR 52-69). There were no differences in the median number of years from the diagnosis to the surgery between groups. The median age of death was 76 years (IQR 68-78) with a mean time since surgery of 5.5 years (SD 3.8). 9 patients (50%) died of aspiration pneumonia, 2 of heart attack, one of mesenteric ischemia, another of neoplasia and one due to postoperative cerebral hemorrhage.

Conclusion: Pneumonia is the most frequent cause of death in patients with advanced PD regardless of treatment. The results show that the median age at the time of surgery is significantly higher in the group that died, probably due to chronobiological evolution. Patients over 70 years can benefit from DBS without surgery significantly increasing the risk of mortality.

Disclosure: Nothing to disclose

EPR2101

Nigro-striato-pallidal lacunes, white matter hyperintensities and radio-clinical correlations in Parkinson's disease: an MRI-based observational case-control study

D. Motavasseli¹, S. Lehericy², G. Mangone³, J.-C. Corvol³, M.J.D. Vidailhet⁴, R. Gaurav², J.-M. Gracies¹

¹Federation of Neurorehabilitation, Albert Chenevier - Henri Mondor University Hospitals, Créteil, France, ²Pitié-Salpêtrière Hospital, Centre de Recherche de l'Institut du Cerveau et de la Moelle épinière, INSERM UMRS_1127, Paris, France, Centre de Neuroimagerie de Recherche, Paris, France, ³Université Pierre et Marie Curie Centre de recherche de l'Institut du Cerveau et de la Moelle épinière, INSERM UMRS_1127, CIC_1422, Département de Neurologie, APHP, Pitié-Salpêtrière Hospital, Paris, France, ⁴Fédération de Neurologie, Groupe Hospitalier de la Pitié Salpêtrière, Paris, France

Background and aims: Vascular parkinsonism is poorly defined, often diagnosed when extrapyramidal signs occurs following a symptomatic stroke. Accumulation of 'asymptomatic' small vessel lesions is often considered of 'fortuitous discovery' and has received little consideration. This study aimed to quantify nigro-striato-pallidal lacunes and white matter hyperintensities (WMH) on MRI in Parkinson's disease (PD) and in matched healthy subjects, and to explore the correlations between these lesions and the clinical signs of PD.

Methods: Retrospective MRI study using blinded comparison of number and volume of lacunes in basal ganglia, as well as WMH, between 68 PD and 34 control subjects comparable in age and sex from the ICEBERG cohort. Radio-clinical correlations between UPDRS-III symptoms and MRI lesions were explored.

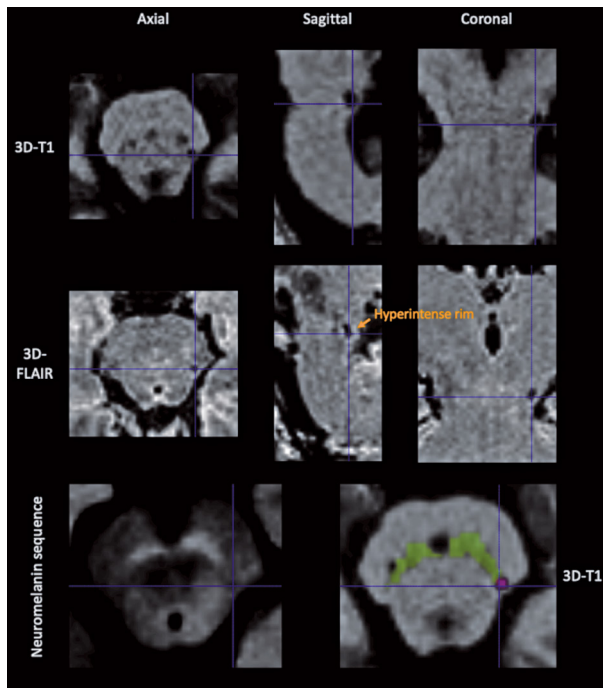

Technique for manual acquisition of a lacune located on the tail of the substantia nigra in a PD patient of the study

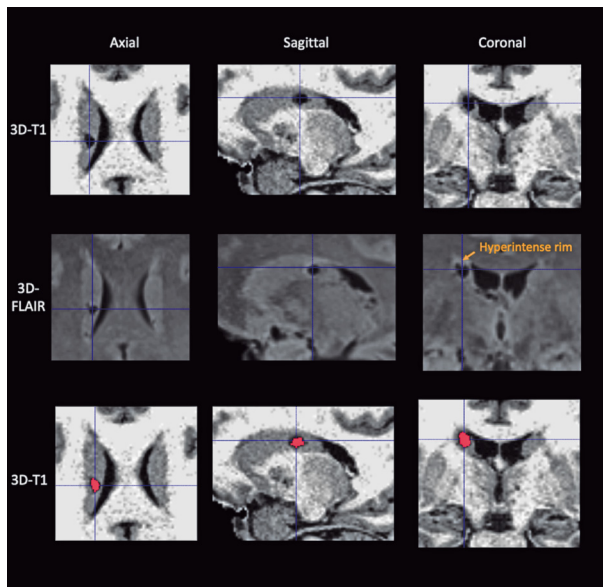

Example of manual acquisition of a lacune located on the right caudate nucleus in a PD patient of the study

Results: Cardiovascular risk factors were of similar distribution in the 2 groups. In PD, there were more lacunes (often larger) in substantia nigra ($p < 0.001$), putamen ($p = 0.003$) and caudate ($p = 0.045$) than in controls, but only on the left side (90% of PD subjects were right-handed). Prevalence of pallidal lesions or WMH was comparable. There were significant correlations between the presence and volume of nigro-striatal lacunes and resting tremor.

Conclusion: In the dominant hemisphere, nigro-striatal lacunes were more prevalent in PD than in a comparable

group of healthy subjects and correlated with resting tremor. If PD symptoms could be worsened by cumulative small vessel nigro-striatal lesions, this could modify the therapeutic management of the disease: stricter control of cardiovascular risk factors would be necessary and the introduction of an antiplatelet medication could be discussed.

Disclosure: Principal investigator has been granted with the Medical Research and Study Fund (Paris Hospitals).

EPR2102

Variability of the APOE, TREM2, SLC1A2 and LINGO1 genes in the occurrence of essential tremor in a Tunisian population

A. Guedi, A. Nasri, S. Zidi, A. Rekik, A. Gargouri, M. Ben Djebara, I. Kacem, R. Gouider

Department of Neurology, LR18SP03, Razi University Hospital, Tunis, Tunisia, La Manouba, Tunisia

Background and aims: Essential tremor (ET) is the most common movement disorder. Despite its prevalence, to our knowledge there is no study on genetic predisposition of this pathology in Tunisia. Our aim was to investigate the role of polymorphisms in different genes in the occurrence of ET in Tunisian population.

Methods: Samples from 110 Tunisian ET patients and 158 healthy controls (HC) were used and the genotyping of 10 polymorphisms in LINGO1, SLC1A2, APOE and TREM2 genes was established by Sanger sequencing, PCR-PFLP and PCR-ARMS.

Results: SLC1A2 rs3794087 ($p=0.0001$ -OR=6.39 [4.31-9.48]) and LINGO1 rs13313467 ($p=0.040$ -OR=1.56[1.01-2.41]) polymorphisms increased the risk of ET. The stratification of patients according to clinical parameters suggested that the 3 LINGO1 polymorphisms favor the development of cognitive disorders. The binding analysis of these 3 variants allowed us to determine a single block with significant linkage disequilibrium. The haplotype study has shown that the GCC haplotype was more frequent in patients who developed cognitive disorders, considered as a risk factor of their occurrence ($p=0.002$) and the ACC haplotype seemed to play a protective role ($p=0.002$).

Conclusion: Our study showed associations between SLC1A2 and LINGO1 and the occurrence of ET and the latter with cognitive disorders. It is assumed that the neuronal degeneration would be influenced by the synergistic action of the different mutations on these genes. Indeed, mutations of SLC1A2 would cause excitotoxicity by EAAT2 deficiency involved in the process of apoptosis of Purkinje cells while LINGO1 amplifies this action and further inhibits the GABAergic effect of the remaining cells on neurons.

Disclosure: Nothing to disclose

EPR2103

Exposure-response efficacy model of apomorphine sublingual film for the treatment of “OFF” episodes in patients with Parkinson’s disease

F. Agbo¹, Y.-Y. Chiu¹, S. Chapel², B. Navia³

¹Sunovion Pharmaceuticals Inc., Fort Lee, USA, ²Ann Arbor Pharmacometrics Group, Inc., Ann Arbor, USA, ³Sunovion Pharmaceuticals Inc., Marlborough, USA

Background and aims: A longitudinal exposure-response model characterized the relationship between apomorphine exposure and efficacy with apomorphine sublingual film (APL-130277; APL) using the MDS-UPDRS Part III score in patients with Parkinson’s disease (PD) and “OFF” episodes.

Methods: MDS-UPDRS data from 4 APL phase 2 and 3 studies and exposure data from a population pharmacokinetic model from 9 studies were analyzed using nonlinear mixed effects modeling methodology as implemented in NONMEM[®] (version 7.3). Final model simulations estimated apomorphine concentration with clinical response.

Results: Overall, 13,171 MDS-UPDRS measurements from 631 nonunique patients were analyzed. The model comprised placebo and nonlinear drug-effect components and predicted a maximal decrease of 20 points from baseline in MDS-UPDRS score, consistent with the phase 2 and 3 clinical data. A cutoff of at least -9.5 points in MDS-UPDRS score corresponded with a FULL “ON” response. Simulations indicated that average apomorphine concentrations of 3.18-3.39 ng/mL corresponded with these outcomes, consistent with the predicted apomorphine maximum concentration of 3.13ng/mL for a 10mg APL dose; however, apomorphine concentrations required for FULL “ON” vary due to interpatient variability. Increasing the APL dose from 10 to 35mg resulted in a faster time to FULL “ON” (18 to 12 minutes) and a greater MDS-UPDRS response with a longer duration of effect (2.4 to 3.9 hours).

Conclusion: The model demonstrated that as apomorphine exposure increased, time to FULL “ON” decreased, while duration and magnitude of response increased, thus supporting the recommended 10-35-mg dose range of APL and the importance of dose optimization.

Disclosure: Supported by funding from Sunovion Pharmaceuticals Inc.

Movement disorders 4

EPR2104

The organisational impact of upcoming treatments in Huntington's disease (HD) in Europe: Resource capacity gaps and access to care implications

M. Pedrazzoli¹, M. Ponomareva¹, M. Moro¹, L. Townson², K. Mukelabai², A. Levine², A.-L. Nordström², M. Guttman³, J.-M. Burgunder⁴, R. Reilmann⁵

¹LSC Life Sciences Consultants, Milan, Italy, ²F. Hoffmann-La Roche Ltd, Basel, Switzerland, ³Centre for Movement Disorders, Toronto, Canada, ⁴Department of Neurology, University of Bern, Berne, Switzerland, ⁵George Huntington Institute, Münster, Germany

Background and aims: HD is a genetic, progressive neurodegenerative disease. While no disease-modifying-therapies (DMTs) are available, several approaches are being considered in clinical development. The investigational drugs most advanced in clinical development are administered intrathecally, requiring additional resources in HD clinics. The impact of upcoming DMTs for HD on healthcare systems and the implications of potential resource capacity gaps on access to care were investigated. **Methods:** 27 HD specialist centres from 6 European countries were involved in a prospective study assessing their capacity to perform intrathecal drug administrations. Data on current resource availability, utilisation, skills and equipment were collected through interviews with >140 healthcare professionals. Resources available in each HD centre were compared to the predicted amount of future resources that the estimated eligible patient population would require.

Results: Only 26% of participating HD teams currently have the required resources to perform intrathecal injections: a skilled "proceduralist" (e.g. trained neurologist, anesthesiologist, interventional radiologist), 1 or more nurses assisting in the procedure, and the appropriate space. When considering all resources available in the hospital (e.g. neurology department, infusion suites), only 22% of HD-specialist clinics are estimated to have enough capacity to serve the eligible population for intrathecally administered DMTs. When simulating the additional referral-in of patients from non-HD-specialised clinics, only 7% of HD clinics have enough capacity.

Conclusion: To ensure adequate care, capacity-constrained healthcare systems will need to plan adequately and ensure providers have sufficient training and resources to deliver new intrathecally administered DMTs, while coping with an increased demand for diagnosis, treatment and follow-up.

Disclosure: Study sponsored by F. Hoffman-La Roche Ltd; the authors thank Kristina Rodriguez, of MediTech Media, for providing editorial support for this abstract.

EPR2105

Voice Handicap Index in patients with Parkinson's disease

D. Ntontos, I. Dagklis, Z. Katsarou, S. Papayiannopoulos, S. Bostantjopoulou

³rd University Department of Neurology, Aristotle University of Thessaloniki, Thessaloniki, Greece

Background and aims: Voice and speech problems are common in Parkinson's disease (PD). In particular, impairments in phonation, articulation and prosody are the commonest characteristics. Voice Handicap Index (VHI) is a questionnaire for measuring the psychosocial handicapping effects of voice disorders.

The purpose of our study is to evaluate the self-perception of voice anomalies and psychosocial discomfort using the VHI in patients with PD.

Methods: 93 patients (74 men and 19 women) with PD participated in the study with mean age 62.8±7.9 years and disease duration of 8.2±4.8 years. Patients with dementia or laryngeal problems were excluded. Motor symptomatology was assessed by means of the Unified Parkinson's Disease Rating Scale-part III. Patients were classified in stages according to the Hoehn and Yahr scale. Patients were asked to fill the VHI, that is a 30 questions scale divided in 3 subscales (functional-physical-emotional). VHI total score from 0-30 indicates minimal amount of handicap, 31-60 moderate and 60-120 severe.

Results: All patients completed the questionnaire. Average VHI total score was 18.5. 5 patients (5.3%) had severe voice handicap (average score 72.2), 16 (17.2%) had moderate handicap (average score 47.2) and 72 (78.4%) had minimal voice handicap (average score 8.3). The functional subscale had the highest average score (7.1). Particularly, questions No1 and 2 ("difficult for people to hear and understand me") had the highest scores.

Conclusion: Voice impairment is common in PD, but it usually produces mild handicap concerning especially difficulty "to be heard". VHI is a useful tool to assess self-perception of voice impairment before starting precision voice treatment strategy.

Disclosure: Nothing to disclose

EPR2106

Withdrawn

EPR2107

Dopamine transporter, age and motor complications in Parkinson's disease: a clinical and SPECT study

G. Palermo¹, S. Giannoni¹, D. Frosini¹, R. Morganti², D. Volterrani³, U. Bonuccelli¹, N. Pavese⁴, R. Ceravolo¹
¹*Department of Clinical and Experimental Medicine, Unit of Neurology, University of Pisa, Pisa, Italy,* ²*Section of Statistics, University of Pisa, Pisa, Italy,* ³*Department of Clinical and Experimental Medicine, University of Pisa, Regional Center of Nuclear Medicine, Pisa, Italy,* ⁴*Neurosciences, University of Newcastle, Newcastle Upon Tyne, United Kingdom*

Background and aims: Previous molecular imaging studies comparing dopamine function in vivo between early-onset Parkinson's disease (EOPD) and late-onset PD (LOPD) patients have shown contradictory results, presumably due to the aging-related decline in nigrostriatal function.

1) To investigate baseline dopamine transporter availability in EOPD (<55y) and LOPD (>70y) patients, specific z-scores values of putamen and caudate [123I]FP-CIT uptake were calculated using the respective age-matched controls in order to correct for early presynaptic compensatory mechanisms and age-related dopamine neuron loss.

2) To examine the associations of such baseline SPECT measures with the emergence of late-disease motor complications

Methods: 105 de novo PD patients who underwent [123I]FP-CIT-SPECT at time of diagnosis were divided into 3 tertile groups according to the age at disease onset (EOPD, n=35; LOPD, n=40). Z-scores values were compared between the 2 groups and their predictive power for motor complications (during a mean follow-up of 7 years) were evaluated using Cox proportional hazard models.

Results: Despite a less severe motor phenotype, EOPD patients exhibited more reduced [123I]FP-CIT binding in the putamen and had a higher and earlier risk for developing motor complications than LOPD. Lower [123I]FP-CIT uptake in putamen and caudate increased the risk of motor complications.

Conclusion: Our findings suggest that a lower dopamine transporter binding in EOPD predicts the later development of motor complications but it is not related to the severity of motor symptoms. Understanding the mechanisms by striatal compensatory strategies contribute to the future disease progression will be crucial for the interpretation of [123I]FP-CIT-SPECT in PD.

Disclosure: Nothing to disclose

EPR2108

Parkin mRNA expression levels in Peripheral Blood Mononuclear Cells in Parkin-related Parkinson's disease

N. Papagiannakis¹, H. Liu², A.M. Simitsi³, C. Koros⁴, M. Stamelou³, M. Maniati⁵, E.-M. Valente⁶, T. Gasser⁷, L. Stefanis⁸

¹*Department of Neurology, National and Kapodistrian University of Athens, Athens, Greece,* ²*University of Tuebingen, Germany, Tübingen, Germany,* ³*Athens, Greece,* ⁴*Piraeus, Greece,* ⁵*Center of Clinical Research, Experimental Surgery and Translational Research, Biomedical Research Foundation of the Academy of Athens, Athens, Greece,* ⁶*University of Pavia, Pavia, Italy,* ⁷*Tübingen, Germany,* ⁸*Chaidari - Athens, Greece*

Background and aims: Parkin is an ubiquitin E3 ligase that monoubiquitinates and polyubiquitinates proteins to regulate a variety of cellular processes. Mutations in parkin (PRKN gene) are the 2nd most prevalent known monogenic cause of Mendelian Parkinson's disease (PD). Loss of Parkin's E3 ligase activity is thought to play a pathogenic role in both inherited and sporadic PD. How mutations in Parkin in a heterozygous or homozygous or compound heterozygote state may affect its transcription in patient-derived biological material has not been systematically studied.

Methods: PRKN mRNA expression levels were measured with Real-time Polymerase Chain Reaction (RT-PCR) in Peripheral Blood Mononuclear Cells (PBMCs). PBMCs were derived from PRKN-mutation carrier PD patients (PRKN-PD; n=12) and healthy controls (n=21). 6 of the PRKN-PD subjects were heterozygous, 4 were compound heterozygous, and 2 were homozygous for pathological mutations.

Results: A statistically significant decrease in PRKN expression levels was present in heterozygous PRKN-PD (mean 592.9±SEM 316) compared to healthy controls (2131±371; p=0.014). Similarly, a statistically significant decrease was found between biallelic PRKN-PD (31.93±15) compared to healthy controls (p<0.001). In fact most biallelic patients have mRNA expression level values close to detection limit, with two samples being below that threshold.

Conclusion: Assessment of PRKN mRNA levels in PBMCs may be a useful way to screen for biallelic mutations in the PRKN gene. Suspicion for certain mutations in a heterozygous state may also be raised based on very low PRKN mRNA levels.

Disclosure: Nothing to disclose

EPR2109

Oral Venglustat in Parkinson's Disease Patients With a GBA Mutation: Part 1 Baseline Characteristics and Results and Part 2 Study Design of the MOVES-PD Trial

M.J. Peterschmitt¹, N. Hattori², H. Saiki³, T. Hatano², T. Gasser⁴, S. Isaacson⁵, J. Kulisevsky⁶, P. Mir⁷, T. Simuni⁸, Y. Takahashi⁹, A.-M. Wills¹⁰, L. Correia Guedes¹¹, P. Svenningsson¹², R. Takahashi¹³, C. Waters¹⁴, M. Katsuno¹⁵, A.J. Ji¹, S.J.M. Gaemers¹⁶, P. Minini¹⁷, S.P. Sardi¹, S. Saubadu¹⁷, T. Fischer¹
¹Sanofi, Cambridge, USA, ²Juntendo University, Tokyo, Japan, ³Kitano Hospital, Tazuke Kofukai Medical Research Institute, Osaka, Japan, ⁴Neurologische Universitätsklinik, Tübingen, Germany, ⁵Parkinson's Disease and Movement Disorders Center, Boca Raton, USA, ⁶Hospital de la Santa Creu i Sant Pau, Barcelona, Spain, ⁷The Biomedical Research Networking Center on Neurodegenerative Diseases (CIBERNED), Madrid, Spain, ⁸Northwestern University, Chicago, USA, ⁹National Center Hospital, Tokyo, Japan, ¹⁰Massachusetts General Hospital, Boston, USA, ¹¹Campus Neurológico Sénior-CNS, Torres Vedras, Portugal, ¹²Karolinska Universitetssjukhuset, Stockholm, Sweden, ¹³Kyoto University, Kyoto, Japan, ¹⁴Columbia University, New York, USA, ¹⁵Nagoya University, Nagoya, Japan, ¹⁶Sanofi, Amsterdam, Netherlands, ¹⁷Sanofi, Chilly-Mazarin, France

Background and aims: Glucocerebrosidase gene (GBA) mutations increase the risk of rapidly progressing Parkinson's disease (PD). MOVES-PD (NCT02906020) is a phase 2, randomised, double-blind, placebo-controlled trial assessing efficacy, safety, and pharmacokinetics/pharmacodynamics of venglustat, a glucosylceramide synthase inhibitor, in PD patients with GBA mutations. Here, we report patient characteristics from MOVES-PD Part 1 and describe the Part 2 study design.

Methods: Part 1 was a placebo-controlled, dose-escalation study in patients from Japan and the rest of the world (ROW). GBA sequencing was done pre-enrolment. Montreal Cognitive Assessment (MoCA) and Movement Disorder Society–Unified Parkinson's Disease Rating Scale (MDS-UPDRS; Parts II/III) scores were collected at baseline. Part 2 is an ongoing 52-week study (target enrolment: 216 patients, randomised 1:1 to placebo or venglustat using the dose selected in Part 1). Efficacy and safety will be assessed.

Results: Of Japanese (n=12) and ROW (n=17) patients enrolled in Part 1, 75.0% and 41.2% had severe GBA mutations (most commonly L444P), respectively, with the remaining carrying mild GBA mutations (eg, E326K, G193W, N370S, R496C). 50% (Japan) and 71% (ROW) of patients had baseline MoCA scores ≥ 26 , indicating no cognitive impairment. Mean baseline MDS-UPDRS Part II/III scores ranged from 43.3–49.0 (Japan) and 30.5–65.8 (ROW). Venglustat decreased glucosylceramide levels in cerebrospinal fluid and had a favourable safety profile in Part 1 patients.

Conclusion: Target engagement by venglustat occurred in patients with a range of GBA mutations and cognitive/motor functionality at baseline. Part 2 will assess venglustat safety and efficacy in a larger cohort of PD patients with GBA mutations.

Disclosure: STUDY SUPPORT: Sanofi.

EPR2110

A Gait Data-Driven Approach to Identify Different Clinical Subtypes of Parkinson's Disease: a Proposal for a New Classification

G. Mostile¹, G. Portaro¹, V. Dibilio², R. Terranova¹, P. Cunsolo¹, F. Contrafatto¹, G. Donzuso¹, C. Rascunà¹, C.E. Cicero¹, A. Luca¹, A. Nicoletti¹, M. Zappia¹
¹Department "G.F. Ingrassia", Section of Neurosciences, University of Catania, Catania, Italy, ²Department "G.F. Ingrassia", Section of Neurosciences; IRCCS Centro Neurolesi Bonino Pulejo, Catania/Italy, University of Catania, Catania, Italy

Background and aims: Gait disorders are characteristics of Parkinson's Disease (PD). Spatio-temporal and kinematic parameters can be routinely quantified by gait analysis. Numerous attempts have been made to identify different clinical subtypes with poor agreement and temporal inconsistency. The principal aim of this study was to identify different clinical subtypes based on cluster analysis of gait parameters applied to a cohort of PD patients.

Methods: We retrospectively analyzed data of PD patients who underwent gait analysis. They all performed 10 trials walking at their self-selected speed along a 6-m walkway during their "on" pharmacological state if treated. A non-hierarchical cluster analysis using k-means method was performed using average values of forty selected spatio-temporal and kinematic parameters for the optimum solution based on the Calinski-Harabasz criterion.

Results: We enrolled 39 patients. 3 different subtypes were identified by cluster analysis: a 1st subtype (A) including the majority of enrolled subjects; a 2nd subtype (B) characterized by pronounced instability, with prominent reduced stance phase, cadence and step length as well as enlarged step width as compared to the other groups; a 3rd phenotype (C) with significant kinematic modifications consisting in pronounced hip flexion-extension and pelvic tilt while walking compared to A and B. No differences were detected in terms of age, disease duration and severity, treatment and cognitive profile among the 3 identified groups.

Conclusion: A gait data-driven approach may be adopted to practically categorize PD patients in different clinical subtypes. This could be helpful to personalize rehabilitative programs since earlier stages of disease.

Disclosure: Nothing to disclose

EPR2111

Opicapone in Clinical Practice in Parkinson's disease Patients with Motor Fluctuations: Findings from the OPTIPARK Study

H. Reichmann¹, A. Lees², J.-F. Rocha³, D. Magalhães³, P. Soares-Da-Silva⁴

¹Department of Neurology, University of Dresden, Dresden, Germany, ²Department of Clinical and Movement Neurosciences, National Hospital for Neurology and Neurosurgery, London, United Kingdom, ³Global Parkinson's Disease Department, BIAL - Portela & Ca S.A., Coronado, Portugal, ⁴Research and Development Department, BIAL - Portela & Ca S.A., Coronado, Portugal

Background and aims: Opicapone (OPC) proved effective in treating end-of-dose motor fluctuations in Parkinson's Disease (PD) patients in 2 large multinational trials (BIPARK-I and II) [1,2]. This real-world study evaluated OPC 50mg in a heterogeneous population of PD patients treated in clinical practice.

Methods: OPTIPARK was a prospective, open-label, single-arm, multicentre trial conducted in Germany and the UK under clinical practice conditions. PD patients with motor fluctuations received OPC 50mg in addition to current antiparkinsonian treatment. Primary efficacy endpoint was Clinician's Global Impression of Change (CGIC) after 3 months. Secondary efficacy endpoints included Patient's GIC (PGIC) and Unified Parkinson's Disease Rating Scale (UPDRS). Safety assessments included evaluation of treatment-emergent adverse events (TEAEs).

Results: 495 patients took \geq OPC dose (Safety Set; Table 1) and 393 completed 3 months' treatment. Of 477 patients with post-baseline efficacy data (Full Analysis Set), 71.3% and 76.8% experienced very much/much/minimal improvement on CGIC and PGIC after 3 months, respectively (Table 2). There were significant improvements on UPDRS II and III scores (Table 3). TEAEs considered at least possibly related to OPC were reported for 45.1% of patients, the most frequently reported (\geq 5% patients) being dyskinesia (11.5%) and dry mouth (6.5%). 94.8% of TEAEs were of mild or moderate intensity. Serious TEAEs considered at least possibly related to OPC were reported for seven (1.4%) patients.

Table 1. Baseline characteristics (Safety Set)

Characteristic	N=495
Male gender, n (%)	315 (63.6)
Age, mean (SD) years	67.7 (9.0)
Disease duration, mean (SD) years	8.5 (5.0)
Duration of motor fluctuations, mean (SD) years	2.5 (3.2)

SD, standard deviation

Table 1

Table 2. CGIC and PGIC results after 3 months (Full Analysis Set)

Category	CGIC	PGIC
	N=477	N=393
Not assessed	3 (0.6)	0
Very much improved	31 (6.5)	30 (7.6)
Much improved	174 (36.5)	159 (40.5)
Minimally improved	135 (28.3)	113 (28.8)
No change	88 (18.4)	58 (14.8)
Minimally worse	28 (5.9)	25 (6.4)
Much worse	15 (3.1)	6 (1.5)
Very much worse	3 (0.6)	2 (0.5)

CGIC, Clinician's Global Impression of Change; LOCF, Last Observation Carried Forward; PGIC, Patient's Global Impression of Change; LOCF applied to CGIC

Table 2

Table 3. Changes from baseline in UPDRS scores (Full Analysis Set)

Scale	N	Mean (SD) change from baseline to 3 months	p-value
UPDRS II (activities of daily living) score at OFF stage	389	-3.0 (4.6)	<0.0001
UPDRS II (activities of daily living) score plus III (motor function) score at ON stage	393	-6.4 (10.4)	<0.0001
UPDRS III (motor function) score at ON stage	391	-4.6 (8.1)	<0.0001

SD, standard deviation; UPDRS, Unified Parkinson's Disease Rating Scale; p-values obtained through Student's t-test

Table 3

Conclusion: OPC 5-mg was effective and generally well tolerated in PD patients with motor fluctuations treated in clinical practice.

1. Ferreira et al., *Lancet Neurol.* 2016;15(2):154-165.
2. Lees et al., *JAMA Neurol.* 2017;74(2):197-206.

Disclosure: Study supported by Bial - Portela & C^a, S.A.

EPR2112

Efficacy and safety of high doses of Safinamide in advanced Parkinson's disease patients in a real-world experience

F. Rodríguez Jorge¹, J. Pagonabarraga Mora², B. Baena Álvarez¹, Á. Beltrán Corbellini¹, P. Parra Díaz¹, J.L. Chico García¹, P. Pérez Torre³, J.C. Martínez Castrillo³, I. Pareés³, A. Alonso Cánovas³
¹Neurology, Hospital Universitario Ramón y Cajal, Madrid, Spain, ²Neurology, Hospital de Santa Creu i Sant Pau, Barcelona, Spain, ³Neurology, Hospital Ramón y Cajal, Madrid, Spain

Background and aims: Standard doses of safinamide (50-100mg) have proved efficacious as an add-on treatment to levodopa in fluctuating Parkinson's disease (PD). Glutamatergic modulation with safinamide 100mg seems to increase with higher doses, whose safety has been proved in preclinical trials.

Methods: Retrospective analysis of electronic records of PD patients treated with safinamide >100mg (April 2019-December 2019).

Results: 15 PD fluctuating patients, with insufficient motor control with safinamide 100mg, 10 (66.6%) male, median age 74 (IQR 16), disease duration 13 years (IQR 10), Hoehn-and-Yahr stage 3 (IQR 2), who were switched to 150mg (4) or 200 (11) mg safinamide, and followed a median of 3 months (IQR 5) were analysed. 4 patients were also treated with DBS (26.7%). Mean UPDRS IV items of dyskinesia duration (2.5±1.3 vs. 2.2±1.1), functional impact (1.6±1.2 vs. 1.1±1.1), pain (0.6±1 vs. 0.3±0.7) and off duration (2±0.8 vs. 1.3±0.5) did not change significantly. However, 9 patients (60%) had a Clinical Global Impression of improvement (CGI 1-3): in 8 cases regarding off duration, in 3 cases regarding dyskinesia duration, in 4 in dyskinesia functional impact and in 2 in pain due to dyskinesia. In 1 patient levodopa doses were decreased. 3 patients (20%) had mild-moderate adverse events leading to suspension of the drug in 2 (both due to dyskinesia worsening). 1 patient discontinued safinamide 200mg due to levodopa/carbidopa intestinal infusion.

Conclusion: In our experience with advanced PD patients, safinamide >100mg was overall well tolerated, and had a clinical benefit in a subset of patients.

Disclosure: Nothing to disclose

EPR2113

Longitudinal changes of retinal morphology in Wilson's disease assessed by optical coherence tomography: Results from 47 patients over 5 years

S. Samadzadeh¹, P. Vanessa Jouvenal¹, J. Schüttfort¹, A.K. Müller¹, M. Novak¹, M. Ringelstein², M. Weise¹, S. Meuth³, J. Kremer⁴, O. Aktas¹, H.-P. Hartung⁵, H. Hefter¹, P. Albrecht¹

¹Department of Neurology, University Hospital of Düsseldorf, Düsseldorf, Germany, ²Neurology, Medical Faculty, Heinrich Heine University, Düsseldorf, Germany, ³Klinik für Allgemeine Neurologie und Institut für Physiologie I - Neuropathophysiologie, Universitätsklinikum, Muenster, Germany, ⁴Neurology, University hospital of Muenster, Muenster, Germany, ⁵1st Department of Neurology, Heinrich-Heine-Universität Düsseldorf, Düsseldorf, Germany

Background and aims: To longitudinally investigate the changes in retinal morphology of Wilson's disease (WD) patients compared to healthy controls (HC) analyzing the influence of laboratory findings, disease severity, and therapy.

Methods: Spectral-domain OCT was used to assess the retinal morphology of 47 patients with WD and 44 HC measuring the peripapillary retinal nerve fiber layer (pRNFL) thickness as well as the thickness of all retinal layers in macular volume scans. The longitudinal data were gathered over 5 years, with at least 2 assessments for each individual. Generalized Estimating Equation (GEE) and mixed effects linear models were used to study retinal layer changes over time within and between controls and patients.

Results: At baseline, WD patients presented about 2.8 and 4.2µm³ lower values compared to controls for mRNFL and GCIPL, respectively (p<0.05, corrected for age). The longitudinal analysis of WD patients revealed an annual thickness loss of -0.07µm, -0.1 µm, p<0.05 in RNFL and GCIPL layer, respectively. The expected discrepancy between control and WD patients over time was associated with almost 2.4µm more pronounced thinning of RNFL and GCIPL layers in WD compared to HC (p<0.05). The analysis of clinical findings further revealed a significant association only for the non-motor WD symptoms, indicating 0.7µm RNFL thickness reduction per non-motor symptoms increment.

Conclusion: Our data corroborate previous findings of reduced RNFL and GCIPL values in WD patients and, for the first time, demonstrate it in a longitudinal analysis. A more detailed investigation of the longitudinal changes over 5 years will be presented.

Disclosure: Nothing to disclose

EPR2114

Premotor compensatory mechanisms in Parkinson's disease with LRRK2-R1441H mutation

S. Sambin¹, S. Lavisse², C. Decaix³, G. Mangone¹, F. Cormier¹, B. Le Toullec¹, S. Lesage⁴, P. Remy⁵, A. Brice⁴, J.-C. Corvol¹

¹Department of Neurology, Sorbonne University, Assistance Publique Hôpitaux de Paris, Inserm, CNRS, ICM, Pitié-Salpêtrière Hospital, Paris, France, ²MIRcen, UMR CNRS 9199, CEA/IBFJ/DRF/LMN, Paris Saclay University, Fontenay-aux-Roses, France, ³Department of Neurology, Sorbonne University, Assistance Publique Hôpitaux de Paris, Saint-Antoine Hospital, Paris, France, ⁴Department of Genetics, Sorbonne University, Assistance Publique Hôpitaux de Paris, Inserm, CNRS, ICM, Pitié-Salpêtrière Hospital, Paris, France, ⁵Centre Expert Parkinson, NPI Team, Paris-Est University, Assistance Publique Hôpitaux de Paris, INSERM, IMRB, Henri Mondor Hospital, Ecole Normale Supérieure, Paris, France

Background and aims: Increased dopamine metabolism has been suggested as a compensatory mechanism in the premotor phase of PD. Little is known about the delay between compensatory mechanisms and motor symptoms onset. Here, we report the longitudinal investigation of PET scan brain imaging in a family with LRRK2-R1441H mutation including one participant who converted nine years after inclusion.

Methods: 4 family members were included: 2 patients with PD (aged 67 and 59, PD duration 11 and 8 years) carrying the mutation (LRRK2+PD+), 1 unaffected sibling carrying the mutation (age 61, LRRK2+PD-) and 1 unaffected non-carrier (age 61, LRRK2-PD-). Subjects underwent clinical evaluation and PET-scan for dopamine transporter binding (11C-PE2I) and L-DOPA uptake (18F-DOPA) repeatedly at two years interval.

Results: At baseline, LRRK2+PD+ patients had -77% and -82% decrease of 11C-PE2I binding, and -81% and -70% decrease of 18F-DOPA uptake in the most affected putamen relative to normal data. The LRRK2+PD- participant had -57% decrease of 11C-PE2I binding in the left putamen (right binding in the normal range), whereas 18F-DOPA uptake was not altered (-21%) but decreased progressively over time, reaching -51% at the time of conversion, 9 years after inclusion. PET imaging parameters of the LRRK2-PD-subject were typical normal values and remained stable during follow-up.

Conclusion: This observation confirms the early upregulation of L-DOPA metabolism compensating dopaminergic nerve terminal loss up to 9 years before conversion to clinical PD. This is the 1st report associating evolution of distinct presynaptic markers and clinical evaluation over 9 years before PD diagnosis.

Disclosure: Nothing to disclose

EPR2115

Depression is associated with impulse-compulsive disorders in Parkinson's disease. Results of the COPPADIS Study Cohort.

D. Santos¹, T. De Deus², E. Suárez², S. Jesus Maestre³, P. Mir⁴, B. Pascual⁵, J. Pagonabarraga⁶, J. Kulisevsky⁷, J. Hernández-Vara⁸, L. Planellas⁵, I. Cabo⁹, M. Seijo Martínez¹⁰, I. Legarda Ramírez¹¹, F. Carrillo¹², N. Caballo¹³, E. Cubo¹⁴, V. Nogueira¹⁵, G. Alonso Losada¹⁶, N. López Ariztegui¹⁷, I. González Aramburu¹⁸, J. García Caldentey¹⁹, C. Borrue Fernandez²⁰, C. Valero Merino²¹, P. Sanchez Alonso²², P. Martinez-Martin²⁰

¹Neurology, Complejo Hospitalario Universitario de A Coruña (CHUAC), A Coruña, Spain, Corunna, Spain,

²Neurology, CHUF (Complejo Hospitalario Universitario de Ferrol), Ferrol, Spain, ³Seville, Spain, ⁴Unidad de Trastornos del Movimiento, Unidad de Trastornos del Movimiento del Hospital Universitario Virgen del Rocío. Instituto de Biomedicina e Investigación de Sevilla (IBIS), Seville, Spain, ⁵Neurology, Hospital Clínic de Barcelona, Barcelona, Spain, ⁶Barcelona, Spain, ⁷Neurology - Movement Disorders Unit, Sant Pau Hospital, Barcelona, Spain,

⁸Neurology, Hospital Universitario Vall d'Hebron, Barcelona, Spain, ⁹Neurology, Complejo Hospitalario Universitario de Pontevedra (CHOP), Pontevedra, Spain,

¹⁰Pontevedra, Spain, ¹¹Palma de Mallorca, Spain,

¹²Neurology, Hospital Universitario de Canarias, San Cristóbal de la Laguna, Santa Cruz de Tenerife, Spain,

¹³Neurology, Consorci Sanitari Integral, Hospital Moisès Broggi, Sant Joan Despí, Barcelona, Spain, ¹⁴Neurology, Hospital Universitario de Burgos, Burgos, Spain,

¹⁵Neurology, Hospital Da Costa de Burela, Lugo, Spain,

¹⁶Neurology, Hospital Álvaro Cunqueiro, Complejo Hospitalario Universitario de Vigo (CHUVI), Vigo, Spain,

¹⁷TOLEDO, Spain, ¹⁸Neurology, ⁹Hospital Universitario Marqués de Valdecilla, Santander, Spain, ¹⁹Neurology,

Centro Neurológico Oms 42, Palma de Mallorca, Spain,

²⁰Madrid, Spain, ²¹Valencia, Spain, ²²Neurology, Hospital Universitario Puerta de Hierro, Madrid, Spain

Background and aims: Depression and impulse control disorders (ICDs) are both common in Parkinson's disease (PD) patients, and their coexistence is frequent. Our objective was to determine the relationship between depression and impulsive-compulsive disorders in a large cohort of PD patients.

Methods: PD patients recruited from 35 centers of Spain from the COPPADIS cohort from January/2016, to November/2017, were included in the study. The QUIP-RS was used for screening ICDs (cutoff points: gambling ≥ 6 , buying ≥ 8 , sex ≥ 8 , eating ≥ 7) and compulsive behaviors (CBs) (cutoff points: hobbyism-punding ≥ 7). Mood was assessed with the BDI-II and major, minor and subthreshold depression were defined.

Results: Depression was more frequent in PD patients with impulse-compulsive disorder than in those without: 67% (71/106) vs 47.9% (246/514); $p < 0.0001$. Major depression

was more frequent in this group as well: 22.6% (24/106) vs 14.8% (76/514); $p = 0.035$. Depression was also more frequent in both patients with ICDs (64.5% [49/76] vs 49.3% [268/544]; $p = 0.009$) and CBs (62.7% [35/59] vs 49.6% [276/556]; $p = 0.038$). Considering types of impulse-compulsive disorders individually, depression was more frequent in patients with gambling (90% [9/10] vs 50.5% [306/606]; $p = 0.012$), eating (66.7% [28/42] vs 50% [289/578]; $p = 0.026$), and hobbyism-punding (70.5% [31/44] vs 49.4% [282/571]; $p = 0.005$). To suffer from impulse-compulsive disorder was associated with depression (OR=2.109; 95%CI 1.261-3.526; $p = 0.004$) after adjustment to age, gender, disease duration, equivalent daily levodopa dose, Hoehn&Yahr stage and non-motor symptoms burden.

Conclusion: Depression is associated with impulse-compulsive disorders in PD. Specifically, with gambling, eating and hobbyism-punding.

Disclosure: Nothing to disclose

MS and related disorders 4

EPR2116

Fingolimod improves the functional recovery of the optic pathway in focal demyelination model of rat optic chiasm

M. Ghasemikasan¹, M. Hashemian², H. Parsian², F. Sadeghi³

¹Babol, Iran, Islamic Republic of, ²Biochemistry, Babol University of Medical Sciences, Babol, Iran, Islamic Republic of, ³Virology, Babol University of Medical Sciences, Babol, Iran, Islamic Republic of

Background and aims: Fingolimod (FTY720) possesses beneficial effects on remyelination in the central nervous system (CNS). In the present study, the effects of FTY720 and sodium valproate (VPA) as histone deacetylase inhibitor (HDAC) on the conductivity of visual signals, extent of demyelination area, and expression levels of HDAC1 and S1PR1 have been evaluated in the optic chiasm of lysolecithin (LPC)-induced demyelination model.

Methods: In order to induce demyelination model, LPC (1%, 2 μ L) was injected into the rat optic chiasm. Latency of visual waves was measured by visual evoked potential (VEP) recording. The extent of demyelination area was assessed using Fluoromyelin staining. Gene expression analysis was performed to evaluate the expression levels of HDAC1, S1PR1, Olig2, and MBP in the optic chiasm.

Results: Analysis of electrophysiological data showed that FTY720 improved the functional recovery of the visual pathway. FTY720 enhanced myelin repair and up-regulated the expression levels of Olig2 and MBP. Additionally, the expression levels of HDAC1 and S1PR1 were significantly reduced in animals treated with FTY720. In contrast to FTY720 treated animals, administration of VPA could not significantly improve the functional recovery of optic pathway following LPC injection.

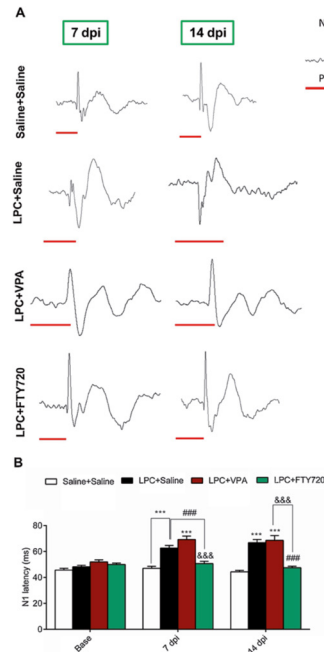

Fig. 1. FTY720 improved the functional recovery of the optic pathway in LPC-induced demyelination model. A) Sample traces of VEP waves. Scale bar=10 μ V, 50ms. B) Quantitative analysis of N1 latency. n=6.

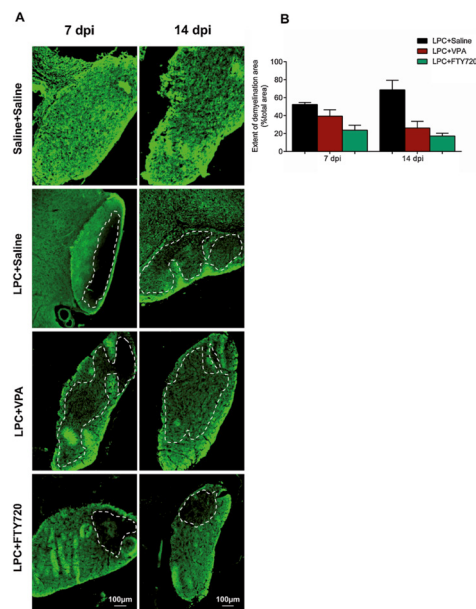

Fig. 2. FTY720 reduced demyelination level in the optic chiasm. A) Fluoromyelin staining. Scale bar: 100 μ m. B) Quantitative analysis of fluoromyelin staining results. Dashed line indicated the extent of demyelination area. n=3.

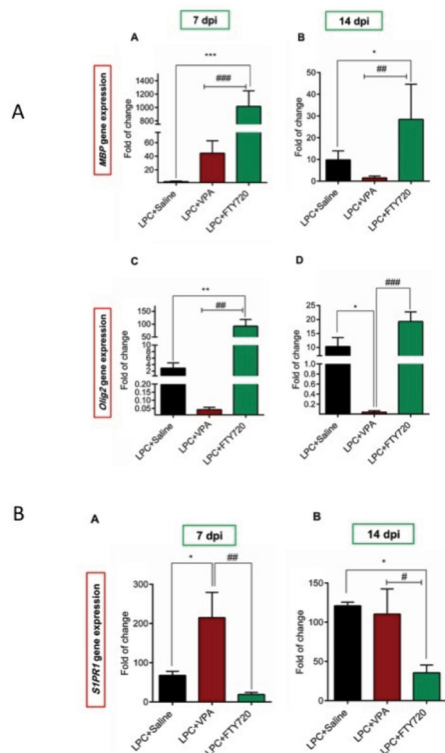

Fig. 3. A) The effect of FTY720 on expression levels of MBP and Olig2 on days 7 and 14 post lesion. B) The effect of FTY720 application on expression levels of S1PR1 on days 7 and 14 post insult. n=6.

Conclusion: Cumulatively, the results of the present study demonstrate that FTY720 application improves the functional recovery of the optic pathway by reducing demyelination levels and down-regulating of S1PR1 and HDAC1.

Disclosure: Nothing to disclose

EPR2117

Updated Safety of Cladribine Tablets in the Treatment of Patients with Multiple Sclerosis: Integrated Safety Analysis and Post-Approval Data

S. Cook¹, G. Giovannoni², T. Leist³, G. Comi⁴, S. Syed⁵, A. Nolting⁶, D. Damian⁵, R. Schick⁶

¹Rutgers, The State University of New Jersey, New Jersey Medical School, Newark, USA, ²Queen Mary University of London, Blizard Institute, Barts and The London School of Medicine and Dentistry, London, United Kingdom, ³Division of Clinical Neuroimmunology, Jefferson University, Comprehensive MS Center, Philadelphia, USA, ⁴Department of Neurology and Institute of Experimental Neurology, Università Vita-Salute San Raffaele, Ospedale San Raffaele, Milan, Italy, ⁵EMD Serono Research & Development Institute Inc., Billerica, USA, ⁶Merck KGaA, Darmstadt, Germany

Background and aims: Integrated analysis of pooled long-term safety data allowed comprehensive characterisation of the cladribine tablets (CT) 10mg (3.5mg/kg cumulative dose over 2 years [CT3.5]) safety profile in patients with relapsing multiple sclerosis (RMS). By integrating final data from the PREMIERE registry, and reporting post-approval safety data from worldwide sources, this analysis provides an update to the serious treatment emergent adverse event (TEAE) profile of CT3.5.

Methods: The monotherapy oral cohort (CT3.5, N=923, patient-years [PY]=3936.69; placebo [PBO], N=641, PY=2421.47) comprised patients from the CLARITY, CLARITY Extension and ORACLE-MS trials, and PREMIERE. Adjusted incidences per 100PY were calculated for AEs, cumulative to the end of PREMIERE (October 2018). Serious and non-serious AEs from post-approval sources are summarised.

Results: Patient characteristics were balanced between treatment groups (mean age [37.8 years, CT3.5; 37.2 years, PBO], proportion of females [66.3%, CT3.5; 66.1%, PBO] and proportion of patients with prior disease modifying drug experience [19.9%, CT3.5; 20.4%, PBO]). Incidences per 100PY for ≥ 1 serious TEAE and serious TEAEs of special interest for CT3.5 and placebo in the monotherapy oral cohort from the clinical program are shown in Table 1. Post-approval, the Periodic Benefit-Risk Evaluation Report listed 1622 AEs; 275 were serious; none represented a new safety signal.

Table 1. Serious TEAEs of special interest in the monotherapy oral cohort from the clinical program						
Incidences per 100PY System organ class Preferred term	Cladribine tablets 3.5 mg/kg (n=923)			Placebo (n=641)		
	n	Total PY	Adj-AE/100 PY	n	Total PY	Adj-AE/100 PY
≥1 serious TEAE	133	3498.1	3.80	68	2226.2	3.05
Blood and lymphatic system disorders	10	3912.7	0.26	0	2421.5	0
Lymphopenia	4	3925.4	0.10	0	2421.5	0
Infections and infestations	23	3857.2	0.60	10	2395.8	0.42
Herpeszoster	2	3929.7	0.05	0	2421.5	0
Pneumonia	6	3907.4	0.15	3	2415.2	0.12
Pulmonary tuberculosis	1	3933.6	0.03	0	2421.5	0
Tuberculosis	1	3936.7	0.03	0	2421.5	0
UTI	4	3923.4	0.10	1	2419.9	0.04
Neoplasms benign, malignant and unspecified	26	3865.7	0.67	8	2398.7	0.33
Malignant tumours	10	3918.9	0.26	3	2414.8	0.12
Uterine leiomyoma	6	3905.7	0.15	2	2413.1	0.08

Serious was defined as resultant in death, life-threatening, required inpatient hospitalisation, congenital anomaly or birth defect, or was otherwise considered as medically important.
Adj-AE per 100PY, adjusted adverse events incidences per 100 patient-years; PY, patient-years; TEAE, treatment-emergent adverse event; UTI, urinary tract infection.

Table 1

Conclusion: No new major safety findings were identified in this finalised integrated dataset comprising final data from PREMIERE. This profile is consistent with previously published integrated safety analyses. No new safety signals were identified in the real-world post-approval data of CT.

Disclosure: This study was sponsored by EMD Serono Inc, a business of Merck KGaA, Darmstadt, Germany (in the USA), and Merck Serono SA, Geneva, an affiliate of Merck KGaA Darmstadt, Germany (ROW).

EPR2118

Siponimod Slows Physical Disability Progression and Decline in Cognitive Processing Speed in SPMS Patients with Active Disease: A Post Hoc Analysis of the EXPAND Study

R. Gold¹, L. Kappos², R.H.B. Benedict³, A. Bar-Or⁴, P. Vermersch⁵, G. Giovannoni⁶, R.J. Fox⁷, T. Hach⁸, S. Ritter⁹, N. Rouyrre⁸, G. Karlsson⁸, B.A.C. Cree¹⁰
¹Department of Neurology, St. Josef-Hospital/Ruhr-University Bochum, Bochum, Germany, ²Neurologic Clinic and Polyclinic, Departments of Medicine, Clinical Research, Biomedicine and Biomedical Engineering, University Hospital and University of Basel, Basel, Switzerland, ³Department of Neurology, University at Buffalo, Buffalo, New York, USA, ⁴Center for Neuroinflammation and Experimental Therapeutics and Department of Neurology, Perelman School of Medicine, University of Pennsylvania, Philadelphia, PA, USA, ⁵Univ. Lille, INSERMU995, CHU Lille, FHU Imminent, Lille, France, ⁶Blizard Institute, Barts and The London School of Medicine and Dentistry, Queen Mary University of London, London, United Kingdom, ⁷Mellen Center for Treatment and Research in Multiple Sclerosis, Neurological Institute, Cleveland Clinic, Cleveland, OH, USA, ⁸Novartis Pharma AG, Basel, Switzerland, ⁹Novartis Pharmaceuticals Corporation, East Hanover, NJ, USA, ¹⁰Department of Neurology, UCSF Weill Institute for Neurosciences, University of California San Francisco, San Francisco, CA, USA

Background and aims: Siponimod significantly reduced confirmed disability progression (CDP) and cognitive processing speed (CPS) decline in the broad secondary progressive multiple sclerosis (SPMS) population (EDSS 3.0–6.5) in the EXPAND study. Siponimod received a positive CHMP opinion for the treatment of adult SPMS patients with active disease. Here, we assess the efficacy of siponimod on CDP and CPS in SPMS patients with active disease from the EXPAND study.

Methods: Analysis included 779 patients with active disease (presence of relapses in the 2 years before screening and/or ≥1 gadolinium-enhancing T1 lesion at baseline); 516 received siponimod 2mg and 263 received placebo in the EXPAND core part. Outcomes: time-to-3- and 6-month (3m/6m) CDP in all active disease patients and 6mCDP in further subgroups of patients with active disease based on prior treatment (any disease-modifying therapy [DMT], interferon at anytime and recent interferon use); and clinically meaningful (≥4-point change on Symbol Digit Modalities Test) sustained improvement/worsening in CPS in all active disease patients.

Results: Siponimod significantly reduced the risk of 3mCDP by 31% (p=0.0094) and 6mCDP by 37% (p=0.0040) versus placebo in all active patients and consistently in subgroups of patients switching from any DMT, interferon at anytime or recent interferon use (p<0.05 for all). Siponimod improved the chance of sustained improvement in CPS by 51% (p=0.0070) and reduced the risk of sustained worsening by 28% (p=0.0166) versus placebo (Table).

Efficacy parameter	Siponimod 2 mg N=516	Placebo N=263	HR (95% CI)	p-value
Disability progression				
3mCDP ^a				
SPMS patients with active disease	24.9% (128/515)	34.6% (91/263)	0.69 (0.53; 0.91)	0.0094
6mCDP ^a				
SPMS patients with active disease	19.0% (98/515)	28.1% (74/263)	0.63 (0.47; 0.86)	0.0040
Subgroups of patients with active disease				
Any DMT	20.3% (80/394)	29.1% (59/203)	0.67 (0.48; 0.94)	0.0203
Interferon at any time	21.2% (65/306)	29.9% (48/154)	0.68 (0.47; 1.00)	0.0496
Recent interferon	17.6% (36/205)	31.7% (33/104)	0.52 (0.32; 0.83)	0.0063
Cognitive processing speed				
SPMS patients with active disease				
Sustained ^b worsening in CPS ^c	27.3% (140/512)	38.2% (100/262)	0.72 (0.56; 0.94)	0.0168
Sustained ^b improvement in CPS ^c	34.2% (175/ 512)	22.9% (80/ 262)	1.51 (1.12; 2.04)	0.0070

^aBased on EDSS score
^bA change that continued until the end of the core part of the study, or occurred at the last assessment
^cMeasured by a ≥ 4 -point change on Symbol Digit Modalities Test
Data are presented as % (n/N); n is number of patients with events; N is number of patients included in the analysis
Number of patients in the subgroups: 597 in any DMT group; 460 in interferon at any time group; 309 in recent interferon group
CDP, confirmed disease progression; CI, confidence interval; CPS, cognitive processing speed; DMT, disease-modifying therapy; EDSS, Expanded Disability Status Scale; HR, hazard ratio; m, month; SPMS, secondary progressive multiple sclerosis

Table. Efficacy of siponimod on disability progression and cognitive processing speed in patients with active disease

Conclusion: In patients with active SPMS, siponimod significantly delayed disability progression in the entire group, and in subgroups defined by prior treatment, and showed significant benefits on CPS.

Disclosure: This study was funded by Novartis Pharma AG, Basel, Switzerland. A detailed disclosure from each author will be included in the oral/poster presentation.

EPR2119

Perceptual and visuospatial functions in multiple sclerosis

M.Y. Perez Martin¹, M. González-Platas²

¹Neurology, Hospital Universitario de Canarias, La Laguna, Spain, ²Service of Neurology, Hospital Universitario de Canarias, La Laguna, Spain

Background and aims: Perceptual and visuospatial (PVS) functions are affected in a significant number of patients with multiple sclerosis (MS), they have been less evaluated than other functions. The interpretation of the findings is often difficult due to the frequent affectation of the afferent visual pathway, which could limit the validity of the results of the studies. The involvement of PVS functions has been associated with the progressive forms of MS or has even taken as a marker of diffuse cerebral involvement of progression. Objective was to describe PVS and relate them with clinical variables

Methods: 185 patients with MS were included; mean age 42±10 years, 130 women, mean disease duration 10±7 years, 172 Relapsing-Remitting forms, 8 2ndary-progressive and 5 Primary Progressive. Expanded Disability Status Scale (EDSS) score 2.0 (median). All participants were evaluated with the Hopper Visual Organization Test (HVOT) and the Judgement Orientation Line Test (JOLT).

Results: 9.7% of patients had impaired perceptual functions (HVOT) and 16.75% had impaired visuospatial functions (JOLT). PVS functions perform was negatively correlated with disease duration. Visuospatial functions were not related to EDSS but patients with high level of disability performed significantly worse than patients with low and without disability. No significant differences were found in JOLT associated with the evolutionary type of the disease but patients with progressive forms performed significantly worse in HVOT.

Conclusion: The impairment of PVS functions in MS is significantly higher in subjects with progressive forms and moderate/high neurological disability. Disease duration is an important factor to determinate the affectation of these functions.

Disclosure: Nothing to disclose

EPR2120

Multimodal Evoked Potentials in Primary Progressive Multiple Sclerosis: Identification of Patients at Risk for Disease Progression

M. Hardmeier¹, R. Schlaeger¹, A. Lascano², L. Toffolet³, C. Schindler⁴, C. Gobbi³, P. Lalive D'epinay², J. Kuhle¹, L. Kappos¹, P. Fuhr¹

¹Neurology, University Hospital and University of Basel, Basel, Switzerland, ²Neurology, University Hospital of Geneva (HUG), Geneva, Switzerland, ³Neurology, Regional Hospital Lugano (EOC), Lugano, Switzerland, ⁴Swiss Tropical and Public Health Institute, Basel, Switzerland

Background and aims: To enhance power, clinical trials in primary progressive multiple sclerosis (PPMS) need patients at risk for progression. Quantitatively scored multimodal evoked potentials (mmEP) measure altered signal conduction and predict clinical disability in PPMS (Schlaeger et al. 2014).

To evaluate an EP-score cut-off as predictor of disease progression in PPMS patients from the Swiss Multiple Sclerosis Cohort.

Methods: 35 PPMS patients (median age: 51.6 years; EDSS: 4.0 [range 2.0-7.0]) had EDSS over 2 years and baseline mmEP (upper and lower limb sensory and motor EP). A modified quantitative EP-score (mqEPS; height-corrected N20-, P40- and cortico-motor-latencies) was used in logistic regression with 2-year EDSS-progression as outcome (increase of EDSS by 1.0 if EDSS <5.5, by 0.5 otherwise).

Results: Progression occurred in 12 subjects (34%). Progressors were younger ($p=0.034$) and had higher mqEPS ($p=0.006$). Significant predictors were age (OR=0.9; CI 95%: 0.82-0.99) and mqEPS (OR=1.28; CI 95%: 1.04-1.57); in a multivariate model, only mqEPS remained significant. Excluding 2 non-progressing subjects with outlying EDSS (6.5 and 7.0), mqEPS predicted progression with an OR=1.81 (CI 95%: 1.12-3.08; $p=0.016$). The cut-off mqEPS=4.0 showed a good sensitivity (75%) and high specificity (90%) translating into an event rate of 64%.

Conclusion: High mqEPS predicts disease progression in PPMS in particular if EDSS <6.5. Event rates may be substantially increased if patients are selected by mmEP. The mqEPS cut-off needs further validation in an independent sample.

Disclosure: the EP-SMSC study has been financially supported by the Swiss Multiple Sclerosis Society

EPR2121

Malignancy Rates With Long-term Use of Ozanimod in Relapsing Multiple Sclerosis Trials

H.-P. Hartung¹, B.A.C. Cree², K.W. Selmaj³, E.K. Havrdova⁴, G. Comi⁵, J.K. Sheffield⁶, N. Minton⁶, A. Lindholm⁶, N. Ding⁶, A. Bar-or⁷

¹Department of Neurology, Medical Faculty, Heinrich-Heine University, Düsseldorf, Germany, ²Weill Institute for Neurosciences, Department of Neurology, UCSF University of California San Francisco, San Francisco, USA, ³Center for Neurology, Łódź, Poland and Collegium Medicum, Department of Neurology, University of Warmia and Mazury, Olsztyn, Poland, ⁴Department of Neurology and Center for Clinical Neuroscience, First Medical Faculty, Charles University, Prague, Czech Republic, ⁵Department of Neurology, San Raffaele Scientific Institute, Vita-Salute San Raffaele University, Milan, Italy, ⁶Bristol-Myers Squibb, Summit, USA, ⁷Center for Neuroinflammation and Experimental Therapeutics, and Multiple Sclerosis Division, Perelman School of Medicine, University of Pennsylvania, Philadelphia, USA

Background and aims: By modulating sphingosine 1-phosphate receptor subtype 1, ozanimod reduces circulating lymphocytes, potentially increasing susceptibility to malignancy. Herein we evaluate malignancy rates with long-term exposure to ozanimod in clinical trial participants with RMS.

Methods: SUNBEAM (NCT02294058; ≥ 12 months) and RADIANCE (NCT02047734; 24 months) were multicenter, randomised, double-blind, phase 3 trials comparing oral ozanimod HCl 1 and 0.5mg/day with intramuscular interferon β -1a 30 μ g/week in adults (18–55 years) with RMS. Participants who completed any ozanimod RMS clinical trial were eligible to enrol in an open-label extension trial (DAYBREAK; NCT02576717) of ozanimod HCl 1mg/d. Malignancy rates with ozanimod are compared descriptively in controlled phase 3 trials (SUNBEAM and RADIANCE) and in participants who received ozanimod in any RMS trial.

Results: In pooled controlled phase 3 studies, 882 participants received ozanimod HCl 1mg and 892 received 0.5mg (mean [SD] combined exposure, 17.9 [5.97] months; 2686.8 person years [PY] on study). The incidence of treatment-emergent malignancy (4 nonmelanoma skin cancers, 4 noncutaneous malignancies) was 0.5% and incidence rate was 298.2/100,000 PY (Table). With longer term exposure to ozanimod in any RMS trial ($n=2787$; data cutoff 31/1/2019; mean [SD] exposure, 37.1 [14.7] months; 8688.3 PY on study), overall incidence of malignancy (11 nonmelanoma and 1 melanoma skin cancer, 13 noncutaneous malignancies) was 0.9% and incidence rate was 289.3/100,000 PY. No lymphomas were reported.

Table. Treatment-Emergent Malignancies by Preferred Term in Participants With RMS Who Were Exposed to Any Dose of Ozanimod HCl (0.5 and/or 1 mg)

	Phase 3 Population (N=1774)		Overall RMS Population (N=2787)	
	Incidence, n (%)	Study Duration-Adjusted IR/100,000 PY ^a	Incidence, n (%)	Study Duration-Adjusted IR/100,000 PY ^a
Treatment-emergent malignancies	8 (0.5)	268.2	25 (0.9)	288.3
Cutaneous	4 (0.2)		12 (0.4)	
Basal cell carcinoma	3 (0.2)	111.8	9 (0.3)	104.0
Keratoacanthoma	1 (0.06)	37.2	1 (0.04)	11.5
Squamous cell carcinoma	0	0	1 (0.04)	11.5
Malignant melanoma	0	0	1 (0.04)	11.5
Noncutaneous	4 (0.2)		13 (0.5)	
Breast cancer ^b	Overall: 3 (0.2) Females only: 3/1174 (0.3)	Overall: 111.7 Females only: 168.7	Overall: 5 (0.2) Females only: 5/1888 (0.3)	Overall: 67.7 Females only: 88.4
Cervix carcinoma	0	0	1 (0.04)	11.5
Testicular seminoma (pure) stage I ^c	1 (0.06)	37.2	1 (0.04)	11.5
Bile duct cancer	0	0	1 (0.04)	11.5
Clear cell renal carcinoma	0	0	1 (0.04)	11.5
Glioblastoma	0	0	1 (0.04)	11.5
Malignant neoplasm	0	0	1 (0.04)	11.5
Pancreatic carcinoma metastatic	0	0	1 (0.04)	11.5
Papillary thyroid cancer	0	0	1 (0.04)	11.5
Treatment-emergent malignancies, excluding NMSC	4 (0.2)	148.9	14 (0.5)	161.7

^aIR/100,000 PY, incidence rate per 100,000 person years, calculated as number of persons having the malignancy of interest/person years × 100,000, where person years = (date first malignancy of interest - date of first dose of study drug + 1)/365.25; for subjects not having the malignancy of interest, the time on study is the study duration (last date on study - first dose date of study drug + 1)/365.25.
^bBreast cancer includes cases using preferred terms of invasive breast cancer, breast cancer, and breast neoplasm.
^cDiagnosed on study day 51.
 NMSC, nonmelanoma skin cancer; RMS, relapsing multiple sclerosis.

Table

Conclusion: In RMS participants with longer ozanimod exposure, rates of malignancy were similar to those with ≤24 months' exposure in controlled phase 3 trials and consistent with rates in MS patients and the age-matched general population.

Disclosure: The DAYBREAK study and all parent studies were sponsored by Celgene, a wholly-owned subsidiary of Bristol-Myers Squibb.

EPR2122

Safety of Ocrelizumab in Multiple Sclerosis: Updated Analysis in Patients With Relapsing and Primary Progressive Multiple Sclerosis

S.L. Hauser¹, L. Kappos², X. Montalban³, L. Craveiro⁴, R. Hughes⁴, K. Prajapati⁵, H. Koendgen⁴, A. Pradhan⁶, J.S. Wolinsky⁷

¹University of California, San Francisco, San Francisco, CA, USA, ²University Hospital Basel, University of Basel, Basel, Switzerland, ³Vall d'Hebron University Hospital, Barcelona, Spain, ⁴F. Hoffmann-La Roche Ltd, Basel, Switzerland, ⁵GCE Solutions Inc., Amsterdam, Netherlands, ⁶Genentech, Inc., South San Francisco, CA, USA, ⁷McGovern Medical School, The University of Texas Health Science Center at Houston (UTHealth), Houston, TX, USA

Background and aims: Ongoing safety reporting is crucial to understanding the long-term benefit-risk profile of ocrelizumab in multiple sclerosis (MS). Safety/efficacy of ocrelizumab have been characterised in Phase II (NCT00676715) and III (NCT01247324/NCT01412333/NCT01194570) trials in relapsing-remitting MS, relapsing MS (RMS) and primary progressive MS (PPMS). We report ongoing safety evaluations from ocrelizumab clinical trials and open-label extension periods up to September 2019 and selected post-marketing data.

Methods: Safety outcomes are reported for the ocrelizumab all-exposure population in Phase II/III and ongoing Phase IIIb trials. The number of post-marketing ocrelizumab-treated patients is based on estimated number of vials sold and US claims data. To account for different exposure lengths, rates per 100 patient years (PY) are presented.

Results: In clinical trials, 4,611 patients with MS received ocrelizumab (14,329 PY of exposure) as of January 2019. Reported rates per 100 PY (95% confidence interval) were: adverse events (AEs), 252 (249–254); serious AEs, 7.33 (6.89–7.79); infections, 76.7 (75.3–78.2); serious infections, 1.99 (1.77–2.23); malignancies, 0.46 (0.35–0.58); and AEs leading to discontinuation, 1.08 (0.92–1.27). As of October 2019, over 125,000 patients with MS have initiated ocrelizumab globally in the post-marketing setting. Updated ocrelizumab all-exposure population data using a September 2019 cut-off and selected post-marketing data will be presented.

Conclusion: Reported rates of events remain generally consistent with the controlled treatment period in RMS/PPMS populations. Rates of serious infections and malignancies remain within the range reported for patients with MS in real-world registries. Regular reporting of long-term safety data will continue.

Disclosure: Sponsored by F. Hoffmann-La Roche Ltd; writing and editorial assistance was provided by Articulate Science, UK.

EPR2123

Therapeutic effects of Leukadherin1 on mobility defects and demyelinated areas in an animal model of multiple sclerosis

S. Hemmati, M.A. Sadeghi, H. Yousefi-Manesh, N. Rezaei, A. Dehpour

Tehran University of medical sciences, Tehran, Iran, Islamic Republic of

Background and aims: Peripheral immunity cells participate in the development and exacerbation of multiple sclerosis (MS). These cells infiltrate MS lesions and produce extensive amounts of inflammatory cytokines and reactive oxygen species. Myeloperoxidase (MPO), the main mediator of oxidative stress in neutrophils, is reported to be elevated in MS lesions. Leukadherin1, a specific CD11b/CD18 agonist, has been shown to inhibit transmigration of inflammatory cells to tissue injury sites. Therefore, we evaluated effects of leukadherin1 on an animal model of MS.

Methods: C57Bl/6 mice were immunized with 100ug MOG 35-55 emulsion to induce experimental autoimmune encephalitis (EAE). On the immunization day and 2 days later, animals were subjected to intraperitoneal injection of pertussis toxin. 3 days after injection, all animals in the treated group received daily 1mg/kg leukadherin1 intraperitoneally. Clinical signs of EAE were observed daily from day 7 onwards. The specific lumbar spinal tissues were isolated on day 35 in order to observe infiltrations of CD45+ leukocytes and MPO+ neutrophils. Furthermore, the extent of demyelinated areas was assessed as a hallmark of disease severity.

Results: Leukadherin1 exhibited promising improvements in EAE clinical scores and reduced demyelinated areas in comparison with the untreated EAE group ($p=0.0018$). Moreover, spinal tissues of treated animals showed reduced number of infiltrated CD45+ leukocytes and MPO+ neutrophils ($p=0.0015$ and $p=0.0005$, respectively).

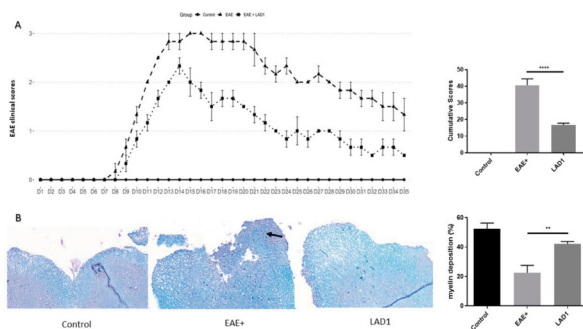

(a) Leukadherin1 resulted in significant decrease in EAE scores starting from day 10 ($p=0.0122$) until the end of day 35 ($p<0.0001$). Cumulative scores were also reduced ($p<0.0001$). (b) The micrographs present stained tissues and demyelinated area with the arrow. Quantified demyelinated area showed significant difference between groups ($p<0.0001$).

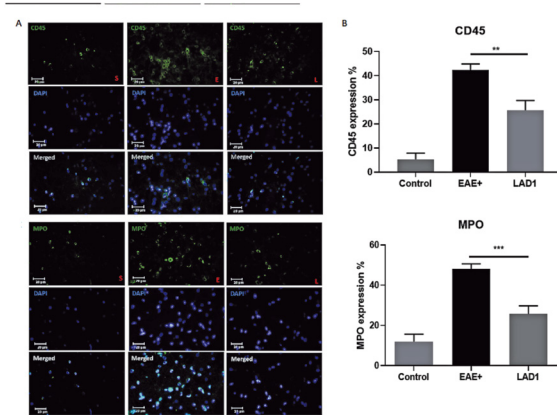

(a) Spinal sections were double immunolabeled for DAPI and cell type-specific markers (green) MPO (neutrophils), CD45 (leukocytes). (b) Quantitative analysis CD45+ and MPO+ cells revealed that leukadherin1 decreased the number of infiltrative leukocytes and microglia ($p<0.01$ & $p<0.001$, One-way ANOVA, post-hoc).

Conclusion: Our study showed beneficial effects of leukadherin1 on clinical and pathological features of a multiple sclerosis model in mice. We suggest leukadherin1 as a potential therapeutic agent to be evaluated in further clinical trials.

Disclosure: Nothing to disclose

EPR2124

Efficacy of Diroximel Fumarate in Relapsing-Remitting MS Patients Who Are Newly Diagnosed or Previously Treated With Interferons or Glatiramer Acetate

E. Jasińska¹, S. Wray², T. Ziemssen³,
R. Leigh-Pemberton⁴, H. Chen⁵, S. Kapadia⁵, J. Hanna⁶,
M. Gudesblatt⁷

¹Collegium Medicum UJK and Clinical Center, RESMEDICA, Kielce, Poland, ²Hope Neurology MS Center, Knoxville, USA, ³Center of Clinical Neuroscience, Carl Gustav Carus University Hospital, Dresden, Germany, ⁴Alkermes, Waltham, USA, ⁵Biogen, Cambridge, USA, ⁶Biogen, Maidenhead, United Kingdom, ⁷South Shore Neurologic Associates, Patchogue, USA

Background and aims: Diroximel fumarate (DRF) is a novel oral fumarate recently approved in the United States for relapsing forms of multiple sclerosis (MS). EVOLVE-MS-1 (NCT02634307) is an ongoing, open-label, Phase 3 study of long-term safety, tolerability, and treatment effect of DRF in adults with relapsing-remitting MS (RRMS).

Methods: 2-year efficacy outcomes as of 30 November 2018 were assessed in subgroups of patients from EVOLVE-MS-1 who were newly diagnosed with RRMS (≤ 1 -year since diagnosis and treatment-naïve; n=109) or previously treated with interferon- β or glatiramer acetate (IFN/GA) as their most recent disease-modifying therapy (n=327; Table 1).

Results: Median (range) DRF exposures were 96 (2-99) weeks for newly diagnosed and 69 (0-99) weeks for IFN/GA switch patients. Adjusted annualized relapse rate was 0.13 (95% CI 0.07-0.23) in newly diagnosed and 0.17 (95% CI 0.12-0.23) in IFN/GA switch patients, representing an 88.6% (95% CI 79.8-93.6; $p < 0.0001$) and 73.2% (95% CI 63.1-80.6; $p < 0.0001$) reduction, respectively, from the 12 months before study entry (Figure 1). Mean (SD) Expanded Disability Status Scale scores remained stable at Wk96 versus baseline (newly diagnosed: 2.00 [1.06, n=60] vs 2.02 [1.13, n=108]; IFN/GA switch: 2.55 [1.55, n=100] vs 2.64 [1.51, n=310]). More patients were Gd+ lesion-free at Wk96 versus baseline (newly diagnosed: 86.9% vs 54.1% [n=61]; IFN/GA switch: 93.9% vs 78.6% [n=98; Figure 2]). Patient-reported outcomes remained relatively stable or improved.

Conclusion: DRF demonstrated improvements from baseline on clinical and radiological endpoints and may be an effective treatment option in newly diagnosed and IFN/GA switch patients.

Support: Biogen/Alkermes

Table 1. Baseline Demographics and Disease Characteristics in Newly Diagnosed and IFN/GA Switch Patients from EVOLVE-MS-1

	Newly Diagnosed ^a (n = 109)	IFN/GA Switch ^b (n = 327)	Overall (n = 888)
Mean (SD) age, y	36.0 (10.8)	43.6 (10.4)	42.4 (10.8)
Female, n (%)	78 (72)	242 (74)	637 (72)
US region, n (%)	31 (28)	184 (56)	395 (45)
Prior DMT, n (%)	0	327 (100)	674 (75.9)
Median (range) duration of prior GA/IFN treatment ^c , y		1.8 (0–20.9)	N/A
Mean (SD) time since diagnosis, y	0.4 (0.5)	8.5 (6.9)	7.5 (7.3) ^d
Mean (SD) no. relapses previous year	1.2 (0.7)	0.6 (0.8)	0.7 (0.8)
Mean (SD) EDSS score	2.0 (1.1)	2.6 (1.5)	2.7 (1.5)
Mean (SD) no. Gd+ lesions	1.9 (5.1)	1.0 (3.2) ^e	1.2 (3.7) ^f
Patients with Gd+ lesions, n (%)	48 (44)	79 (24)	268 (30)

DMT = disease modifying therapy; EDSS = Expanded Disability Status Scale; GA = glatiramer acetate; Gd+ = gadolinium-enhancing; IFN = interferon; N/A = data not available

^aNewly diagnosed patients were diagnosed within one year of screening and without any prior DMT (immunomodulator, immunosuppressant, or intravenous immunoglobulin use [investigational or approved]; steroids were not included).

^bIFN/GA switch patients received IFN/GA as their most recent DMT, with no restrictions on the lengths of the gap between the prior medication end date and the study medication first dose date.

^cn = 160; if there was more than one treated IFN/GA period, only the most recent treatment period was summarized.

^dn = 887

^en = 325

^fn = 885

Table 1. Baseline Demographics and Disease Characteristics in Newly Diagnosed and IFN/GA Switch Patients from EVOLVE-MS-1

Figure 1. Newly Diagnosed and IFN/GA Switch Patients in EVOLVE-MS-1 Had a Reduction in ARR on DRF Treatment Compared With the 12 Months Before Study Entry

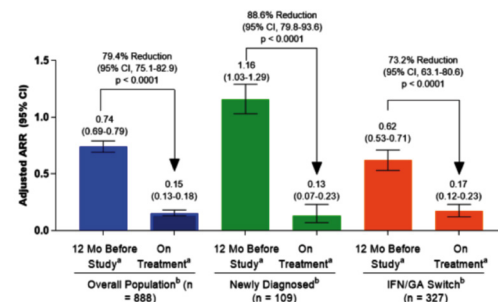

ARR = annualized relapse rate; DRF = diroximel fumarate; GA = glatiramer acetate; IFN = interferon

^aAdjusted ARR comparison between patient-reported relapses in the 12 months before study entry and protocol-defined relapses occurring at any time on treatment was based on a Poisson regression model.

^bRelapse was evaluated in all patients who received ≥ 1 dose of DRF (overall population) and in subgroups of patients who were newly diagnosed with multiple sclerosis or who received IFN/GA as their most recent disease-modifying therapy.

Figure 1. Newly Diagnosed and IFN/GA Switch Patients in EVOLVE-MS-1 Had a Reduction in ARR on DRF Treatment Compared With the 12 Months Before Study Entry

Figure 2. More Newly Diagnosed and IFN/GA Switch Patients Were Gd+ Lesion-Free at Week 96 Compared With Baseline

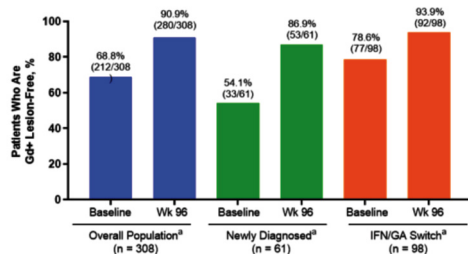

DRF = diroximel fumarate; Gd+ = gadolinium-enhancing; GA = glatiramer acetate; IFN = interferon

^aRadiological outcomes were assessed in patients who received 1 dose of DRF and completed ≥ 1 post-baseline efficacy assessment (overall population) and in subgroups of newly diagnosed and IFN/GA switch patients. Baseline included those with Week 48 and Week 96 data (n = 308 for the overall population, n = 61 for newly diagnosed patients, and n = 98 for IFN/GA switch patients).

Figure 2. More Newly Diagnosed and IFN/GA Switch Patients Were Gd+ Lesion-Free at Week 96 Compared With Baseline

Disclosure: This study was funded by Biogen (Cambridge, MA, USA) and Alkermes (Waltham, MA, USA); medical writing support was provided by Excel Scientific Solutions (Fairfield, CT, USA) and funded by Biogen.

EPR2125

The effect of self-assessed fatigue and cognitive impairment on health care consumption, work capacity and utility: A study in 5475 patients in Germany.

G. Kobelt¹, Q. Hou², S. Dong², K. Jomaa², P. Flachenecker³

¹European Health Economics AB, Stockholm, Sweden, ²Value & Access, Biogen, Cambridge, USA, ³Neurological Rehabilitation Center Quellenhof, Bad Wildbad, Germany

Objectives: To investigate the effect of self-assessed fatigue and cognitive impairment on direct health care consumption, work participation and utility in People with multiple sclerosis (MS) in Germany.

Methods: The study included 5,475 German participants in a large European burden of illness study in 16 countries that investigated - in addition to resource consumption - fatigue, cognitive impairment and the effect of MS on work using visual analogue scales (0-10). The analysis controlled for gender, age, disease duration, education, disability and use of DMTs.

Results: The level of severity of fatigue and cognitive impairment was significantly and independently correlated with all resource utilisation. Total inpatient and outpatient costs increased significantly with symptom severity ($p < 0.0001$), as did individual resources. Utility decreased by 0.034 and 0.028 for each VAS point in severity of fatigue and cognitive impairment, respectively. With each VAS point increase in severity of symptoms, the probability of working was reduced by 10.6% for cognitive impairment ($p < 0.0001$) and 4.9% for fatigue ($p = 0.005$). Work hours decreased in linear fashion with each point of increasing severity for both symptoms, while sick leave increased accordingly ($p < 0.0001$). Both symptoms significantly affected productivity at work ($p < 0.0001$).

Conclusion: This study shows that fatigue and cognitive impairment have a significant impact regardless of physical disability on both productivity and working capacity as well as on the quality of life and resource utilization.

Disclosure: Funded by Biogen

EPR2126

Leptomeningeal contrast enhancement in adult patients with MOG-antibody associated CNS demyelinating disease: a multi-center study

D. Tzanetakos¹, J.S. Tzartos¹, A. Vakrakou¹,
G. Velonakis², M.E. Evangelopoulos¹, G. Koutsis¹,
M. Anagnostouli¹, M. Breza¹, E. Pantou², I. Markakis³,
D. Papadimitriou⁴, E. Karavasilis², P. Toulas²,
L. Stefanis¹, C. Kilidireas¹

¹*Demyelinating Diseases Unit, 1st Department of Neurology, School of Medicine, Eginition Hospital, National and Kapodistrian University of Athens, Athens, Greece,*

²*Research Unit of Radiology– 2nd Department of Radiology, National and Kapodistrian University of Athens, Athens, Greece,* ³*Department of Neurology, General Hospital of Nikaia, Piraeus, Greece,* ⁴*Department of Neurology, Henry Dunant Hospital, Athens, Greece*

Background and aims: Leptomeningeal contrast enhancement (LMCE) in Multiple Sclerosis (MS) patients has been reported using 3-dimensional-FLAIR-sequences post-gadolinium (3D-FLAIRE) and has been associated with cortical pathology and the presence of ectopic B-cell follicle-like structures. We investigated the presence of LMCE in anti-MOG-positive-patients with CNS demyelinating disease (MOG-group), using 3D-FLAIRE, as an indirect indicator of the pathogenetic role of sustained compartmentalized immune response within the CNS of these patients.

Methods: We evaluated 11 MOG-group patients (MOG-IgG1 serum detection with cell-based-assay) and 14 Relapsing-Remitting MS (RRMS) patients age and sex matched as controls, from 3 Departments of Neurology. LMCE foci were assessed using 3D-FLAIR and T1-weighted sequences pre- and post-gadolinium on 3 Tesla scanner. None had a relapse or received corticosteroids within one month preceding study entry.

Results: Characteristics of our MOG-group were: a) female 72.7% (n=8), b) mean age at MRI acquisition 45.2 years (range 23–75years), c) mean disease duration 47.7 months (range 2-153months). LMCE, identified as foci of hyperintensities on 3D-FLAIRE and not on T1-weighted-contrast-enhanced sequences, was detected in 27.3% (n= 3) all with supratentorial distribution. LMCE in one brain region was observed in 2 patients (parietal n=1, frontal n=1), while the 3rd patient had 3 LMCE foci (parietal, temporal, occipital). In the RRMS-group LMCE was detected in 7.1% (n=1), in the parietal lobe.

Conclusion: To our knowledge, this is the 1st study showing LMCE using 3D-FLAIRE sequence in adults with MOG-antibody associated CNS demyelinating disease; this finding may be indicative of the presence of ectopic B-cell follicle-like structures in the meninges associated with meningeal inflammatory infiltrates.

Disclosure: Nothing to disclose

MS and related disorders 5

EPR2127

Safety of Alemtuzumab in RRMS Patients in the Period Following Lymphocyte Repopulation: Clinical Trial and Postmarketing Experience

J. Jones¹, G. Comi², Ó. Fernández³, L. Kappos⁴, E. Kubala Havrdova⁵, C. Laganke⁶, C. Oreja-Guevara⁷, F. Piehl⁸, A. Traboulsee⁹, P. Vermersch¹⁰, H. Wiendl¹¹, T. Ziemssen¹², E. Poole¹³, A.J. Coles¹

¹University of Cambridge School of Medicine, Cambridge, United Kingdom, ²University Vita-Salute San Raffaele, Milan, Italy, ³Fundacion IMABIS, Hospital Universitario Carlos Haya, Málaga, Spain, ⁴Neurologic Clinic and Policlinic, University Hospital and University of Basel, Basel, Switzerland, ⁵First Medical Faculty, Charles University, Prague, Czech Republic, ⁶North Central Neurology Associates, Cullman, USA, ⁷University Hospital San Carlos, Madrid, Spain, ⁸Neuroimmunology Unit, Department of Clinical Neuroscience, Karolinska Institutet, Stockholm, Sweden, ⁹University of British Columbia, Vancouver, Canada, ¹⁰University of Lille, INSERM U995, CHU Lille, Lille, France, ¹¹University of Münster, Münster, Germany, ¹²Center of Clinical Neuroscience, Carl Gustav Carus University Hospital, Dresden, Germany, ¹³Sanofi, Cambridge, USA

Background and aims: In the CARE-MS trials (NCT00530348, NCT00548405), alemtuzumab significantly improved efficacy outcomes versus subcutaneous interferon beta-1a over 2 years in RRMS patients. Efficacy was maintained in 2 consecutive extension studies (NCT00930553, NCT02255656 [TOPAZ]), wherein patients could receive additional alemtuzumab courses as needed or receive other disease-modifying therapy (DMT) per investigator discretion. Alemtuzumab selectively depletes circulating CD52-expressing B and T lymphocytes, followed by a distinctive pattern of lymphocyte repopulation. Here, we report incidences of adverse events (AEs) of special interest occurring during the postrepopulation period (18–36 months post treatment) using clinical trial and postmarketing data.

Methods: Safety measures in clinical trials included monthly patient questionnaires, complete blood counts, serum creatinine, urinalysis with microscopy, and quarterly thyroid function tests. All patient- and investigator-reported AEs, serious AEs, and medical events of interest were recorded.

Results: Over 9 years in pooled CARE-MS alemtuzumab-treated patients (N=811), incidences of thyroid disorders, immune thrombocytopenia, autoimmune nephropathies, and acute acalculous cholecystitis were 47.6%, 2.7%, 0.4%, and 0.4%, respectively. Among 25,292 patients treated with alemtuzumab in the postmarketing setting as of 31 March, 2019, additional events occurring post repopulation included autoimmune hepatitis (AIH; 10.7 in 10,000) and haemophagocytic lymphohistiocytosis (HLH; 2.7 in 10,000).

Conclusion: AEs occurring after lymphocyte repopulation in RRMS patients treated with alemtuzumab have included thyroid disorders, immune thrombocytopenia, autoimmune nephropathies, and acute acalculous cholecystitis in clinical trials, and rare postmarketing cases of AIH and HLH.

Disclosure: STUDY SUPPORT: Sanofi and Bayer HealthCare Pharmaceuticals.

EPR2128

Long-term Efficacy of Siponimod Treatment for up to 5 Years in Patients with Secondary Progressive Multiple Sclerosis: Analysis of the EXPAND Extension Study

L. Kappos¹, G. Giovannoni², R. Gold³, R.J. Fox⁴, P. Vermersch⁵, R.H.B. Benedict⁶, A. Bar-or⁷, N. Rouyrre⁸, D. Piani-Meier⁸, S. Ritter⁹, A. Kilaru⁸, F. Dahlke⁸, G. Karlsson⁸, B.A.C. Cree¹⁰

¹Neurologic Clinic and Policlinic, Departments of Medicine, Clinical Research, Biomedicine and Biomedical Engineering, University Hospital and University of Basel, Basel, Switzerland, ²Blizard Institute, Barts and The London School of Medicine and Dentistry, Queen Mary University of London, London, United Kingdom, ³Department of Neurology, St Josef-Hospital/Ruhr-University Bochum, Bochum, Germany, ⁴Mellen Center for Treatment and Research in Multiple Sclerosis, Neurological Institute, Cleveland Clinic, Cleveland, Ohio, USA, ⁵Univ. Lille, INSERMU995, CHU Lille, FHU Imminent, Lille, France, ⁶Department of Neurology, University at Buffalo, Buffalo, New York, USA, ⁷Center for Neuroinflammation and Experimental Therapeutics and Department of Neurology, Perelman School of Medicine, University of Pennsylvania, Philadelphia, Pennsylvania, USA, ⁸Novartis Pharma AG, Basel, Switzerland, ⁹Novartis Pharmaceuticals Corporation, East Hanover, New Jersey, USA, ¹⁰Department of Neurology, UCSF Weill Institute for Neurosciences, University of California San Francisco, San Francisco, California, USA

Background and aims: In the EXPAND-Core study, siponimod significantly reduced 3-/6-month (m) confirmed disability progression (3mCDP/6mCDP) and cognitive decline in secondary progressive multiple sclerosis (SPMS) patients. We assessed long-term efficacy of siponimod on disability, cognitive processing speed (CPS) and relapses in SPMS patients from the Core and Extension parts of the EXPAND study.

Methods: This analysis included patients who received ≥ 1 dose of randomised treatment (siponimod 2mg/placebo; 36m Extension data cut-off [April 2019]; total study duration ≤ 5 years). Efficacy analyses included time-to-3mCDP/time-to-6mCDP, time-to-6m confirmed meaningful worsening in CPS (6mCW; ≥ 4 points in SDMT) and annualised relapse rate (ARR) for the continuous (CSG: siponimod in Core/Extension) and switch groups (PSG: placebo in Core/switched to siponimod in Extension).

Results: Of the 1224 (74% of 1651 randomised) patients entering the Extension, 878 (72%) were ongoing. Patients in CSG versus PSG were less likely to experience 3mCDP ($p=0.0064$) and 6mCDP ($p=0.0048$). Time-to-6mCDP was prolonged by 54% for the 25th percentile and risk for 6mCDP reduced by 22% in CSG versus PSG; median time-to-6mCDP not reached for CSG. Decline in CPS on SDMT was delayed ($p=0.0014$) and risk for 6mCW reduced by 23% in CSG versus PSG (Table). ARR was reduced by 52% in CSG versus PSG ($p<0.0001$); the effect was similar for

relapses without complete recovery, requiring steroids/hospitalisations.

Parameter	Continuous siponimod group (N=1099)	Placebo-siponimod group (N=546)	p-value	Relative risk reduction %; HR (95% CI)	Delay in time-to-event %
	KM estimate ^a				
Time-to-6mCDP on EDSS ^b % of patients without event up to Month 48	58.65 (55.34; 61.96)	52.40 (47.56; 57.21)	0.0048 ^b	22% 0.78 (0.66; 0.92)	-
Time to 6mCDP on EDSS for the 25 th percentile Months	21.0	13.6	-	-	54%
Time-to-6mCW on SDMT ^c % of patients without event up to Month 48	68.28 (65.16; 71.39)	58.45 (53.67; 63.24)	0.0014 ^b	23% 0.77 (0.65; 0.92)	-
Time-to-6mCW on SDMT for the 25 th percentile Months	29.6	18.3	-	-	62%

^aKM estimates relate to the end day of the interval. The Greenwood formula is used for the CIs of the KM estimates. The numbers provided in parentheses are CI values. CIs are point-wise rather than simultaneous intervals; ^bUsing a log-rank test stratified by treatment group

³mCDP, 3-month confirmed disability progression; 6mCDP, 6-month confirmed disability progression; 6mCW, 6-month confirmed worsening; CI, confidence interval; CPS, cognitive processing speed; EDSS, Expanded Disability Status Scale; HR, hazard ratio; KM, Kaplan-Meier; SDMT, Symbol Digit Modalities Test

Table. Efficacy results

Conclusion: Benefits on disability, cognitive processing speed and relapses of CSG over PSG gained during the controlled period are sustained for up to 5 years, demonstrating the sustained treatment effect and advantage of early treatment initiation with siponimod in patients with SPMS.

Disclosure: This study was funded by Novartis Pharma AG, Basel, Switzerland. A detailed disclosure from each author will be included in the oral/poster presentation. Abstract also submitted to AAN 2020; acceptance pending.

EPR2129

Ponesimod Versus Teriflunomide in Relapsing Multiple Sclerosis: Efficacy Results from the OPTIMUM Phase 3 Randomised, Double-Blind Superiority Study

R. Fox¹, M. Burcklen², M.S. Freedman³, E.K. Havrdova⁴, B. Hennessy², R. Hohlfeld⁵, F. Lublin⁶, X. Montalban⁷, C. Pozzilli⁸, T. Scherz², P. Linscheid², M. Pirozek-Lawniczek², H. Kracker², T. Sprenger⁹, L. Kappos⁹

¹Cleveland Clinic, Ohio, USA, ²Actelion Pharmaceuticals, Part of Janssen Pharmaceutical Companies, Allschwil, Switzerland, ³University of Ottawa and The Ottawa Hospital Research Institute, Ontario, Canada, ⁴Department of Neurology, Charles University, Prague, Czech Republic, ⁵Institute of Clinical Neuroimmunology, Ludwig Maximilians University Munich, Munich, Germany, ⁶Icahn School of Medicine at Mount Sinai, New York, USA, ⁷Division of Neurology, St. Michael's Hospital, University of Toronto, Toronto, Canada, ⁸S. Andrea MS Centre, Sapienza University of Rome, Rome, Italy, ⁹Departments of Medicine, Clinical Research, Biomedicine and Biomedical Engineering University Hospital Basel, Neurologic Clinic and Policlinic, Basel, Switzerland

Background and aims: Ponesimod, an orally active, highly selective and reversible modulator of sphingosine 1 phosphate receptor 1 (S1P1), causes sequestration of lymphocytes in lymphoid organs thereby preventing lymphocyte recruitment to sites of inflammation. The OPTIMUM study evaluated efficacy of ponesimod versus teriflunomide in adult patients with relapsing multiple sclerosis (RMS).

Methods: Patients (18-55 years) with RMS (expanded disability status scale scores: 0-5.5) were randomised (1:1) to ponesimod 20mg or teriflunomide 14mg for 108 weeks. Primary endpoint was annualised relapse rate (ARR) (confirmed relapses up-to end-of-study [EOS]); 2ndary endpoints included: change from baseline to Week 108 in the symptoms domain of the fatigue symptom and impact questionnaire-RMS (FSIQ-RMS), combined unique active lesions per year (CUALs) on MRI, time to 12-week and 24-week confirmed disability accumulation (CDA). Brain volume loss and no evidence of disease activity (NEDA-3) status were exploratory endpoints.

Results: Of 1133 patients randomised (ponesimod: n=567, teriflunomide: n=566), 86.4% and 87.5% completed study. The efficacy findings are summarised in Table 1. Ponesimod reduced ARR versus teriflunomide by 30.5% (p=0.0003); supplementary analysis results were robust and consistent with the primary analysis (Figure 1). Compared to teriflunomide, ponesimod reduced the FSIQ-RMS weekly symptom score (mean difference -3.57; p=0.0019) and CUALs (p<0.0001). 12-week and 24-week CDA estimates were not significantly different. Brain volume loss at Week 108 was -0.91% versus -1.25% (0.34% difference, p<0.0001) and NEDA-3 was achieved in 25.0% versus

16.4% patients (odds ratio: 1.70, p=0.0004), favouring ponesimod versus teriflunomide.

Table 1: Summary of Efficacy Outcomes

Endpoint	Ponesimod 20 mg N=567	Teriflunomide 14 mg N=566
ARR up to EOS[†]		
Mean estimate	0.202	0.290
(95% CL)	(0.173, 0.235)	(0.254, 0.331)
Treatment effect (rate ratio)	0.695	
(95% CL)	(0.570, 0.848)	
p-value	0.0003	
FSIQ-RMS change from baseline to Week 108[‡]		
LS Mean	-0.01	3.56
(95% CL)	(-1.60, 1.58)	(1.96, 5.16)
LS Mean Difference	-3.57	
(95% CL)	(-5.83, -1.32)	
p-value	0.0019	
CUAL from baseline to Week 108[‡]		
Mean estimate (lesions per year)	1.405	3.164
(95% CL)	(1.215, 1.624)	(2.757, 3.631)
Treatment effect (rate ratio)	0.444	
(95% CL)	(0.364, 0.542)	
p-value	< 0.0001	
Time to first 12-week CDA[‡]		
Hazard ratio	0.83	
95% CL	(0.58, 1.18)	
Log-rank p-value	0.2939	
Time to first 24-week CDA[‡]		
Hazard ratio	0.84	
95% CL	(0.57, 1.24)	
Log-rank p-value	0.3720	

ARR, annualised relapse rate; CDA, confirmed disability accumulation, CL=Confidence limit, CUAL, combined unique active lesions; EOS, end of study; FSIQ-RMS, fatigue symptom and impact questionnaire-relapsing multiple sclerosis; LS= least squares
[†]Negative binomial model is applied with Wald confidence limits and p-value. Offset: log time (years) up to end of study.
[‡]Covariates: EDSS strata (≤3.5, >3.5), DMT in last 2 years prior to randomisation strata (Y, N), number of relapses in year prior study entry (≤1, ≥2), DMT = disease modifying therapy for multiple sclerosis; EDSS = Expanded Disability Status Scale
[§]MMRM = Mixed effects repeated measurements model with unstructured covariance, treatment, visit, treatment by visit interaction, baseline by visit interaction as fixed effects, baseline FSIQ score, EDSS strata (≤3.5, >3.5), DMT in last 2 years prior randomisation strata (Y, N) as covariates. A negative change from baseline indicates an improvement in fatigue symptoms.
[¶]Negative binomial model is applied with Wald confidence intervals and p-value. Offset: Log Time (years) up to last MRI scan.
[‡]Covariates: EDSS strata (≤3.5, >3.5), DMT within last 2 years prior to randomization strata (Y, N), and Gd + TI lesions at baseline (absent or present).
[§]Stratified by EDSS category and DMT within 2 years, Cox regression with Wald confidence limits

Figure 1: ARR Supplementary Analysis (Forest plot with 99% CL)

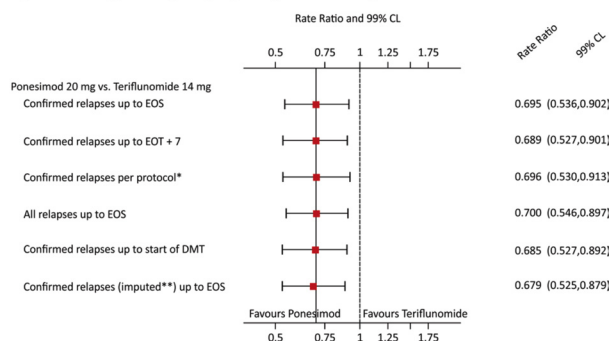

ARR, annualised relapse rate; CL, confidence limit; DMT, disease-modifying therapy; EOS, end of study; EOT, end of treatment
^{*}per protocol set. ^{**}Relapses with missing expanded disability status scale (EDSS) score imputed as confirmed relapses
Rate ratio: treatment effect, i.e. ARR of ponesimod 20 mg relative to that of teriflunomide 14 mg

Conclusion: Ponesimod was superior to teriflunomide on ARR, fatigue symptoms, MRI activity, brain atrophy and NEDA-3 status.

Disclosure: Funding was provided by Janssen Research & Development, LLC, and OPTIMUM study was supported by Actelion Pharmaceuticals, Part of Janssen Pharmaceutical Companies, Allschwil, Switzerland.

EPR2130

The effect of clinical and modifiable prepregnancy and delivery parameters on the clinical status of MS patients : Results of a greek cohort study

D. Kitsos, E. Sideri, M. Chondrogianni, C. Zompola, K. Voumvourakis
Multiple Sclerosis, Attikon Univerisy Hospital, Athens, Greece, Athens, Greece

Background and aims: The objective of this study was to retrospectively evaluate the effect of pre-pregnancy disability level and administered Disease Modifying Treatment (DMT), exclusive breastfeeding, epidural anaesthesia during child delivery and diagnosis of postpartum depression (PPD) on the natural course of Multiple Sclerosis (MS) in terms of current disability status and present relapse rate (rr).

Methods: 100 Greek female MS patients who became pregnant during the years 2006-2009 were retrospectively followed up in regards to the above mentioned parameters as well as pregnancy and postpartum clinical relapses. All had an established diagnosis of Relapse Remit Multiple Sclerosis (RRMS) with disease duration of 15 years. All patients' present clinical status has been assessed with EDSS scale and rr calculation.

Results: Pre-pregnancy EDSS and DMT administration were the most accurate predictors of current EDSS and present rr respectively with very high accuracy ($p < 0.001$). Pregnancy and postpartum clinical relapses could predict current EDSS with high accuracy and present rr with medium to high accuracy ($p < 0.01$). Exclusive breastfeeding was a predictor of present rr with medium accuracy and of current EDSS with medium to high accuracy ($p < 0.01$). Epidural anaesthesia did not seem to have any predictive value while PPD could predict both current EDSS and present rr with medium and low accuracy respectively ($p < 0.04$).

Conclusion: Pre-pregnancy clinical parameters had the highest predictive capability while delivery modifiable ones ranged from nil to high predictive value which may imply that the immune system eventually returns to its pre-pregnancy levels of activity at a patient specific time span.

Disclosure: Nothing to disclose

EPR2131

Quantifying the relationship between disability progression and quality of life in patients treated for neuromyelitis optica spectrum disorder (NMOSD): Insights from the SAKura studies

M. Levy¹, A.R. Haycox², U. Becker³, C. Costantino⁴, E. Damonte³, G. Klingelschmitt³, H.-C. Von Büdingen³, G. Wallenstein⁴

¹Harvard Medical School, Boston, USA, ²University of Liverpool, Liverpool, United Kingdom, ³F. Hoffmann-La Roche Ltd, Basel, Switzerland, ⁴Genentech, San Francisco, USA

Background and aims: To date, no specific scales have been developed to relate NMOSD-related disability and quality of life (QoL). The Expanded Disability Status Scale (EDSS), developed to quantify disability in multiple sclerosis, has not been validated in NMOSD. The EuroQol 5-dimensions (EQ-5D) scale has been applied in patients with NMOSD, though studies are sparse and of limited validity as, currently, none are based on clinical trial data. We combined EDSS and EQ-5D data from 2 clinical trials to quantify the relationship between disability and QoL in NMOSD patients.

Methods: SAKuraSky (NCT02028884) and SAKuraStar (NCT02073279) were Phase 3, multicentre, randomised, international, double-blind, placebo-controlled, parallel assignment studies of satralizumab, administered in combination with baseline immunosuppressants (SAKuraSky) or as monotherapy (SAKuraStar). Patients completed the EDSS and EQ-5D at baseline and at 24-week intervals thereafter. Inclusion criteria specified a baseline EDSS score ≤ 6.5 . The relationship between disability and QoL was assessed by estimating EQ-5D utilities (UK tariff) for each incremental EDSS category. A repeated-measures linear model was used to regress health utilities on EDSS score-derived health states.

Results: Overall, 180 patients completed at least 1 set of EDSS and EQ-5D questionnaires. The most commonly reported EDSS value was 3 (moderate disability), with mean EQ-5D score decreasing in relation to each incremental increase in EDSS disability (Table, Figure). The relationship between EDSS and EQ-5D score remained consistent across the different treatment groups (Figure).

EDSS category	No. of records per EDSS category (%)	EQ-5D score, mean (SD)
0 (no disability)	4 (0.3)	1.00 (0.00)
1 (minimal signs of disability)	122 (9.2)	0.80 (0.20)
2 (minimal/mild disability)	277 (21.0)	0.83 (0.20)
3 (moderate disability)	396 (30.0)	0.76 (0.20)
4 (significant disability)	284 (21.5)	0.61 (0.25)
5 (severe disability)	40 (3.0)	0.53 (0.24)
6 (requires walking aids)	185 (14.0)	0.37 (0.32)
7 (unable to walk)	7 (0.5)	0.31 (0.27)
8 (restricted to powered wheelchair/bed)	6 (0.5)	-0.24 (0.18)

Table – Distribution of patients and mean EQ-5D score (UK tariff) by EDSS category

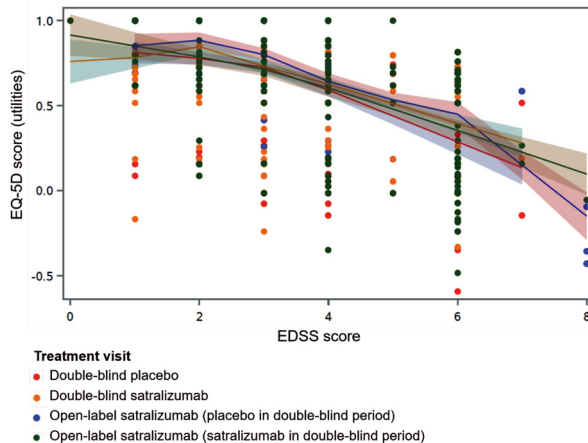

Scatter plot of EQ-5D score (UK tariff) by EDSS state

Conclusion: These results, generated from high-quality clinical trial data, demonstrated a strong and consistent relationship between disability and QoL in patients with NMOSD.

Disclosure: Sponsored by F. Hoffmann-La Roche Ltd.; writing and editorial assistance was provided by ApotheCom, UK.

EPR2132

Effect of interferon beta-1a treatment on serum neurofilament light chain levels in patients with a 1st clinical demyelinating event in the REFLEX trial

J. Kuhle¹, D. Leppert¹, G. Comi², N. De Stefano³, L. Kappos⁴, M. Freedman⁵, S. Roy⁶, D. Issard⁷

¹Neurologic Clinic and Policlinic, Department of Medicine, Biomedicine & Clinical Research, University Hospital Basel, and University of Basel, Basel, Switzerland, ²Department of Neurology and Institute of Experimental Neurology, Universit Vita-Salute San Raffaele, Ospedale San Raffaele, Milan, Italy, ³Department of Neurological and Behavioural Sciences, University of Siena, Siena, Italy, ⁴Neurologic Clinic and Policlinic, University Hospital Basel, and University of Basel, Basel, Switzerland, ⁵University of Ottawa and the Ottawa Hospital Research Institute, Ottawa, Canada, ⁶Merck, Aubonne, Switzerland, ⁷Merck KGaA, Darmstadt, Germany

Background and aims: In REFLEX, patients (pts) with a first clinical demyelinating event (FCDE) treated with subcutaneous interferon beta-1a (scIFN beta-1a) 44mg once (qw) or 3 times weekly (tiw) had significantly delayed conversion to multiple sclerosis (MS; McDonald [McD]-2005 criteria). Effects of scIFN beta-1a 44µg qw or tiw vs placebo (PBO) on serum Neurofilament light chain (sNfL) were assessed. Predictive value of NfL for conversion to McD-MS was explored.

Methods: Pts were randomised to scIFN beta-1a tiw (n=171), qw (n=175) or PBO (n=171) over 2yrs; pts converting to clinically definite MS (CDMS) switched to open-label scIFN beta-1a tiw (only data collected to CDMS conversion included). Serum NfL levels analysed at baseline (Month [M]0), M6, M12, M24. Pts with M0 sNfL data ≥ 1 other time point were included. Treatment effect on sNfL levels was compared using ANCOVA on log-transformed sNfL data, M0 log-sNfL concentration as covariate, with data presented for M6, M12. Percentages of pts converting to McD-MS 2005 by M24 were calculated by Kaplan-Meier curve.

Results: At M0, a median sNfL concentration of 26.1pg/ml defined low/high NfL subgroups. At M6, least square mean (LSM) sNfL concentration was significantly reduced vs PBO with scIFN beta-1a tiw and qw. At M12, only scIFN beta-1a tiw significantly reduced sNfL concentration vs PBO (Figure 1). Proportionally fewer pts with low sNfL converted to McD-MS by M24 (tiw:49.1%[37.9%-60.3%];qw:69.4%[59.0%-79.8%]; PBO:80.2%[71.5%-88.8%]) than high sNfL (tiw:75.2%[65.6%-84.8%];qw:80.6% [72.2%-89.0%]; PBO:91.2%[84.7%-97.6%]).

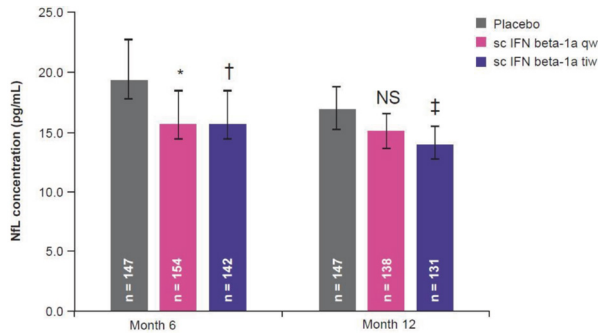

Figure 1: Serum NFL Concentrations (LSM [95% CI]) at Month 6 and 12 by Treatment Group (Statistical significance versus placebo: *P=0.001, †P=0.002, ‡P=0.015, NS non-significant. CI, confidence intervals; IFN, interferon; LSM, least square mean; qw, once weekly; sc, subcutaneous; tiw, 3 times weekly.)

Conclusion: Treatment with scIFN beta-1a tiw or qw reduced sNFL levels in pts with FCDE as early as 6-months post-baseline. High baseline sNFL levels were associated with earlier conversion to McD-MS.

Disclosure: Funded by Merck KGaA, Darmstadt, Germany

EPR2133

Long-term, real-world effectiveness of natalizumab treatment in relapsing-remitting multiple sclerosis (RRMS): data from ≥ 6 years in the TYSABRI® Observational Program (TOP) French and global cohorts

A. Kwiatkowski¹, J.P. Borsotti², F. Sellal³, J.B. Nkondjuo⁴, R. Su⁵, S. Licata⁵, M. Ruiz⁶

¹Neurology Department, Saint Vincent Hospital, Lille Catholic Institute Hospital Group, Lille, France, ²Clinique Mutualiste Bénigne Joly, Talant, France, ³Département de Neurologie, Hôpitaux Civils Colmar, Colmar, France, ⁴Neurologie, CHG Dunkerque, Dunkirk, France, ⁵Biogen, Cambridge, USA, ⁶Biogen, Paris, France

Background and aims: TOP began >10 years ago and is the largest ongoing real-world study in natalizumab-treated RRMS patients. Country-specific data on relapse and disability outcomes, alongside global data, can provide information on natalizumab's effectiveness in local clinical practice.

Methods: Annualized relapse rate (ARR) and cumulative probability of 24-week confirmed disability worsening (CDW; Expanded Disability Status Scale [EDSS] score increase ≥ 1.5 from baseline of 0.0, ≥ 1.0 from baseline of 1.0-5.5, or ≥ 0.5 from baseline ≥ 6.0) and confirmed disability improvement (CDI; EDSS score decrease ≥ 1.0 from baseline ≥ 2.0) were analysed using data from July 2007 to November 2018 in the TOP French (n=189) and global (n=6295) cohorts. Updated data (as of November 2019) will be presented.

Results: At baseline, median (range) disease duration was 8.2 (0.3-34.9) years in the French cohort and 7.2 (0-43.9) years globally, and median (range) EDSS score was 3.5 (0-7.0) in the French cohort and 3.5 (0-9.5) globally. ARR decreased in the French cohort from 1.96 in the year pre-initiation to 0.19 on natalizumab, consistent with the global decrease from 2.00 to 0.21. ARR also decreased in the French and global cohorts regardless of baseline EDSS score or prior therapy use. At 6 years, cumulative probabilities of CDW and CDI were, respectively, 26.2% and 41.8% in the French cohort and 24.8% and 31.3% globally.

Conclusion: Generally consistent with global TOP results, natalizumab ARR remained low and disability stabilized over ≥ 6 years in the French cohort. These results support natalizumab's long-term effectiveness in real-world settings.

Disclosure: This study is supported by Biogen. Detailed disclosures of each author will be included in the e-poster/oral presentation.

EPR2134

JCV serostatus and viral replication in patients with Multiple Sclerosis treated with Ocrelizumab

D. Landi¹, A. Grimaldi¹, C. Prezioso², M. Ciotti³, M. Iannetta⁴, M. Castelli¹, G. Cola¹, C.G. Nicoletti¹, G. Mataluni¹, V. Pietropaolo², G.A. Marfia¹

¹Multiple Sclerosis Center, Tor Vergata Hospital, Rome, Italy, ²Sapienza University of Rome, Rome, Italy, ³Virology Unit, Tor Vergata Hospital, Rome, Italy, ⁴Clinic of Infectious Diseases, Tor Vergata Hospital, Rome, Italy

Background and aims: Rituximab has been associated with progressive multifocal leukoencephalopathy (PML) by John Cunningham Polyomavirus (JCPyV), while the long-term effects of ocrelizumab use, recently approved for multiple sclerosis (MS), are essentially unknown. Here we reported our preliminary data of an ongoing project aimed to explore the anti-JCPyV serostatus and the JCPyV replication in MS patients treated with ocrelizumab.

Methods: 30 MS patients (age 41+/-9, 6 primary progressive, 16 naïve to treatments) starting treatment with Ocrelizumab were recruited. Anti-JCPyV index, JCPyV-DNA in urine and plasma samples, IgG and IgM titres and lymphocyte subsets were longitudinally assessed

Results: At baseline 26/30 patients were anti-JCPyV seropositive (>0,4), 3/30 seronegative (<0,2), and 1/30 was indeterminate (>0,20 and <0,4). 8/26 seropositive and 0/3 seronegative patients had detectable JCPyV-DNA (range: $4 \cdot 10^4$ - $5 \cdot 10^7$ copies) in urine; all were negative for plasma JCPyV-DNA. At 3 months (T3) 27/30 were positive for anti-JCPyV antibodies, 3/30 negative. Mean anti-JCPyV index was marginally reduced at T3 (t-test $p=0.058$). Patients were persistently positive for urinary JCPyV DNA at T3. CD4, CD8 and NK counts and IgG titres did not significantly change from baseline to T3; CD19 counts were significantly lowered ($p<0.001$), as well as IgM titre.

Conclusion: Our data indicate that Ocrelizumab is not associated with increased JCPyV replication; we found a discordance between anti-JCPyV titre and urine JCPyV-DNA load at baseline, suggesting a possible overestimation of PML risk. The validity of anti-JCPyV index to monitor PML risk during ocrelizumab treatment needs to be carefully assessed, considering its potential long-term impact on immunoglobulin titres.

Disclosure: Nothing to disclose

EPR2135

Understanding heterogeneity in comparative effectiveness studies of natalizumab and fingolimod in multiple sclerosis: effect of analytical methodology

M. Lefort¹, S. Sharmin², J. Andersen³, S. Vukusic⁴, N.J. Koch-Henriksen³, D. Laplaud⁵, H. Butzkueven², M. Magyari³, T. Kalincik², E. Leray¹
¹REPERES – EA 7449, University of Rennes, EHESP, Rennes, France, ²CORe, Department of Medicine, University of Melbourne, Melbourne, Australia, Royal Melbourne Hospital, Melbourne, Australia, ³Department of Neurology, Danish Multiple Sclerosis Center and the Danish Multiple Sclerosis Registry, Rigshospitalet and University of Copenhagen, Copenhagen, Denmark, ⁴Foundation Eugene Devic EDMUS, Department of Neurology of Pierre Wertheimer, University Hospital of Lyon, Lyons, France, ⁵Departement of Neurology, Nantes Hospital, Nantes, France

Background and aims: Natalizumab and fingolimod present similar indication as 2nd-line treatment in relapsing-remitting multiple sclerosis (MS) but important differences in terms of safety. Comparative effectiveness studies have shown variable results. These studies used different methods to control indication bias and manage censoring in time-to-event analysis. The objective of this study was to evaluate the impact of statistical methods on the results of analysis of comparative effectiveness.

Methods: 3 observational MS registries (MSBase, Danish MS register and French OFSEP registry) were combined. Four outcomes were studied: count of relapses, time to 1st relapse, time to 1st disability worsening and improvement. 2 propensity scores methods were used: matching and weighting allowing for estimating Average Treatment effect for Treated (ATT) and Average Treatment effect for the Entire population (ATE). Analyses were conducted in intention-to-treat and per-protocol frameworks.

Results: Overall 5,148 patients were included. Irrespective of the methods used, conclusions derived from the different analyses were consistent. In this well-powered sample, 95% confidence intervals of the estimates overlapped, even though point estimates differed between analyses done with different methods. Weighting and matching procedures led to consistent results, confirming that both methods performed well. The most pronounced differences were 2ndary to the type of average treatment effect estimated (ATT with matching and ATE or ATT with weighting). Most differences were related to the definition of censoring; intention-to-treat analyses were more conservative than per-protocol analyses.

Conclusion: This applied study elucidates the influence of methodological decisions on the results of comparative effectiveness studies, given these are sufficiently powered.

Disclosure: This work was part of Mathilde Lefort's Ph.D., which is funded through an unconditional donation from Roche SAS, without any link to the scientific contents of the work.

EPR2136

Influence of Tobacco Smoking in Multiple Sclerosis Onset and Progression

C. Lima¹, Z. Argyropoulou², R. Machado³, I. Correia¹, M.C. Macário⁴, L. Sousa⁵, S. Batista⁴

¹Coimbra, Portugal, ²Lisboa, Instituto Nacional de Medicina Legal, Coimbra, Portugal, ³Centro Hospitalar e Universitário de Coimbra, Coimbra, Portugal, ⁴Neurology, CHUC, Coimbra, Portugal, ⁵Neurology, Centro Hospitalar e Universitário de Coimbra, Coimbra, Portugal

Introduction: Multiple sclerosis (MS) is widely recognized as predominantly associated with environmental factors, among which tobacco smoking is one of the most preponderant.

Aim: To investigate the association between tobacco smoke exposure and MS onset and progression.

Methods: 120 consecutive MS patients were recruited from the outpatient clinic and questioned for past and current smoking status, as well as daily 2nd-hand smoke exposure history. The following clinical variables were also obtained: disease subtype [relapsing-remitting (RRMS) and secondary progressive (SPMS)], EDSS score and age at disease-onset and progression-onset.

Results: Patients were 73.3% female, mean age of disease onset was 32.19 (± 10.30) and mean disease duration 12.27 (± 10.35) years. 87.5% had RRMS and 12.5% SPMS. In regard to smoking status, 22 patients (18.3%) were current-smokers, 57 (47.5%) non-smokers, 27 (22.5%) past-smokers and 14 (11.7%) were 2nd hand-smokers. 32 (26.7%) were smokers at disease onset. Age at disease onset was significantly lower in smokers at onset (29.53 ± 10.04 years vs 34.19 ± 10.10 years, $p=0.031$). Age of smoking initiation ($R^2 0.14$; $p=0.001$) and pack-year load before onset ($R^2 0.32$; $p<0.001$) significantly predicted a younger age at disease onset. Pack-year load after MS onset ($r=0.214$; $p=0.028$) and smoking duration after MS onset ($r=0.387$; $p=0.026$) were also significantly correlated with EDSS. Current smoking status was not associated with EDSS in the RRMS group. In the SPMS group the EDSS was significantly higher in ever-smokers (7.0) and 2nd hand-smokers (6.8) compared to non-smokers (5.5) ($p=0.012$).

Conclusion: In accordance with current literature, our results show a significant effect of smoking, with earlier onset and worse outcome in MS. Thus, there may be a benefit in smoking cessation even after disease onset.

Disclosure: Nothing to disclose

EPR2137

Characterization of MS lesions: Comparison of a new deep learning based solution with academic standard

J.-E. Meissner¹, T. Fritz¹, J. Opalka¹, H. Michaely², P. Mann¹

¹mediaire GmbH, Berlin, Germany, ²MVZ Karlsruhe, Karlsruhe, Germany

Background and aims: Comparison of a new Deep Learning (DL) algorithm with SPM-based academic solutions for lesion segmentation in Multiple Sclerosis (MS).

Methods: White matter lesion detection was carried out using three different algorithms: SPM toolboxes (i) LST and (ii) SLS and (iii) the DL-powered software solution mdbrain. While (i) and (ii) are already widely used in scientific community, (iii) is a new algorithm using a U-net architecture that fully works in 3D. The model was trained with 77 ground truth segmentation masks using augmentation and was validated on 21 datasets. Algorithms were tested on the LITMS dataset (not part of the training data of) that included patients with confirmed MS (Lesion load: 0.34-52.45mL, according to manual segmentation (3 experts) on 3D-T1w/3D-T2-flair). The performances were validated with the F1 score for the detection and the dice score for the segmentation.

Results: For the detection tests, mdbrain showed significantly higher mean F1 score of 0.60 ± 0.08 vs. $0.35 \pm 0.12 / 0.36 \pm 0.12$ for (i)/(ii). Segmentation performance also yielded better mean Dice coefficients of 0.61 ± 0.17 vs. $0.51 \pm 0.20 / 0.51 \pm 0.21$. These results are independent of the lesion load (Table1). A representative slice of (i)-(iii) is shown in Figure1.

Figure1: Representative axial T2-flair slices of two patients from the LITMS dataset. Images of both high and low lesion loads are superimposed with lesion maps of different segmentations, namely: ground truth (red), LST (blue), SLS (violet) and mdbrain (green). White arrows indicate lesions detected only by mdbrain.

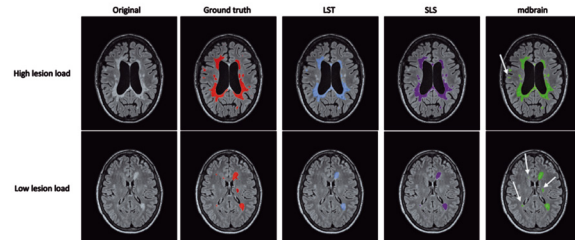

Conclusion: As compared to SPM, mdbrain shows better results for both segmentation and detection, independent of the actual lesion load. This is reflected by the improved mean values and a lower standard deviation. Taking into account the shorter evaluation time (~ 10 sec vs. ~ 4 min) and the fully automated evaluation workflow as compared to SPM, our DL algorithm appears to be a valuable tool for daily application in MS diagnostics in clinical practice.

Disclosure: Nothing to disclose

EPR2138

Correlation of lateral ventricles, corpus callosum and thalamus volume changes: A potential new biomarker for multiple sclerosis

K. Vodehnalova¹, M. Anelova¹, T. Hrnčiarova¹, J. Krasensky², J. Motyl¹, L. Friedova¹, T. Kober³, B. Marechal³, M. Vaneckova², D. Horakova¹

¹Department of Neurology and Center of Clinical Neuroscience, First Faculty of Medicine, Charles University and General University Hospital, Prague, Czech Republic,

²Department of Radiology, First Faculty of Medicine Charles University and General University Hospital in Prague, Prague, Czech Republic, ³Advanced Clinical Imaging Technology, Siemens Healthcare AG, Lausanne, Switzerland

Background and aims: Whole brain atrophy is long studied imaging biomarker in multiple sclerosis (MS) whereas regional morphological changes might contain more specific information and serve as potential early predictors of disease onset and disease progression. This inter dependence of brain regions has been rarely studied. Here, we aim at identifying relationships of regional brain volumes in a group of healthy controls (HC) and compare them with patients with MS (PwMS) with different disability levels.

Methods: MP-RAGE (magnetization-prepared rapid acquisition with gradient echo) images of 2014 PwMS and 102 HC were obtained at 3T (MAGNETOM Skyra Siemens Healthcare, Erlangen, Germany). Morphometry was assessed with the MorphoBox prototype. Partial correlations controlling for age and disease duration were calculated to explore the relationship between regional brain volumes separately for HC and for PwMS, as well as for different physical disability levels (4 groups based on EDSS: 0-1.5; 2.0-3.0; 3.5-4.5 and ≥5.0).

Results: Unexpectedly, corpus callosum and thalamus volumes were positively correlated with lateral ventricles volume in HC. In PwMS the correlation is gradually inverted. The results are summarized in Tables 1-3.

	Healthy individuals	PwMS EDSS 0-1.5	PwMS EDSS 2.0-3.0	PwMS EDSS 3.5-4.5	PwMS EDSS ≥ 5.0
n (% women)	102 (65)	651 (74)	689 (69)	477 (74)	197 (72)
Age	37.1 ± 10.3	38.8 ± 8.7	42.4 ± 9.6	48.0 ± 9.7	49.0 ± 8.9
Disease duration	-	9.7 ± 6.6	11.6 ± 8.1	17.2 ± 9.2	18.9 ± 8.6
Brain volume	1162.3 ± 115.7	1100.3 ± 18.0	1086.1 ± 111.7	1034 ± 9 ± 113.9	1013.6 ± 96.5
Lateral ventricles	17.22 ± 9.5	21.8 ± 11.5	25.6 ± 19.0	30.4 ± 18.1	37.0 ± 23.0
Corpus callosum	5.2 ± 0.9	4.8 ± 0.8	4.8 ± 0.8	4.5 ± 0.8	4.3 ± 0.9
Thalamus	14.3 ± 1.9	13.5 ± 1.5	13.4 ± 1.6	12.8 ± 1.6	12.4 ± 1.4
MUCCA	89.5 ± 7.7	86.0 ± 8.3	84.9 ± 9.2	80.9 ± 10.0	74.2 ± 10.1
TIV	1453.5 ± 132.1	1411.6 ± 120.0	1409.71 ± 128.4	1383.0 ± 131.4	1388.3 ± 121.6

Table 1. Basic characteristics and magnetic resonance volumetric parameters of the enrolled healthy individuals and the PwMS.

Data are displayed as means ± standard deviations; age and disease duration are measured in years; volumetric data are shown in milliliters except area of corpus callosum and MUCCA which are measured in mm². Normalized data are not shown.

EDSS = expanded disability status scale, MUCCA = mean upper cervical cord area, TIV = total intracranial volume.

Table 1

		Healthy individuals	PwMS EDSS 0-1.5	PwMS EDSS 2.0-3.0	PwMS EDSS 3.5-4.5	PwMS EDSS ≥ 5.0
CC / Ventricles	r	0.525	0.050	-0.022	-0.287	-0.387
	p	<0.001	0.211	0.581	<0.001	<0.001
Thalamus / Ventricles	r	0.607	0.110	-0.022	-0.125	-0.294
	p	<0.001	0.006	0.574	0.008	<0.001
CC/Thalamus	r	0.526	0.398	0.501	0.480	0.569
	p	<0.001	<0.001	<0.001	<0.001	<0.001
CC / Brain Tissue	r	0.111	0.241	0.296	0.499	0.526
	p	0.277	<0.001	<0.001	<0.001	<0.001
Ventricles / Brain Tissue	r	-0.220	-0.641	-0.682	-0.732	-0.825
	p	0.029	<0.001	<0.001	<0.001	<0.001

		Healthy individuals	PwMS EDSS 0-1.5	PwMS EDSS 2.0-3.0	PwMS EDSS 3.5-4.5	PwMS EDSS ≥ 5.0
CC / Ventricles	r	0.529	0.049	-0.015	-0.284	-0.389
	p	<0.001	0.220	0.695	<0.001	<0.001
Thalamus / Ventricles	r	0.620	0.160	0.013	-0.169	-0.274
	p	<0.001	<0.001	0.734	<0.001	<0.001
CC/Thalamus	r	0.524	0.398	0.497	0.459	0.528
	p	<0.001	<0.001	<0.001	<0.001	<0.001
CC / Brain Tissue	r	0.097	0.241	0.313	0.515	0.531
	p	0.344	<0.001	<0.001	<0.001	<0.001
Ventricles / Brain Tissue	r	-0.225	-0.595	-0.660	-0.697	-0.818
	p	0.027	<0.001	<0.001	<0.001	<0.001

Table 2 + 3. Relationships between particular brain structures (normalized on total intracranial volume) in healthy individuals and PwMS. In the first table, zero-order correlations are shown; the second table contains correlations after controlling for age and (in PwMS) also disease duration.

CC = corpus callosum [area]; EDSS = expanded disability status scale; p = p-value/significance PwMS = patients with multiple sclerosis; r = Spearman's correlation coefficient.

Table 2 + 3

Conclusion: The correlation between lateral ventricles versus corpus callosum and thalamus, respectively, is strongly positive in HC regardless of age. In PwMS, this relationship becomes weaker and eventually negative in patients with moderate and severe physical disability, whereas the relationship between corpus callosum and thalamus does not change. The results suggest different rates of atrophy of specific structures at different disability levels and might have implications to understand the biology of regional brain atrophy in MS.

Disclosure: This project was supported by Roche, by Progres Q27/LF1, RVO-VFN64165, NV18-04-00168 and GA UK 1154218 projects.

MS and related disorders 6

EPR2139

A substantial 'ependymal-in' gradient of thalamic damage in progressive multiple sclerosis

D. Marastoni¹, A. Bar-or², G. Fadda³, O. Howell⁴, A. Poli⁵, R.A. Brown⁶, A. Tamanti⁵, M. Castellaro⁵, R. Nicholas⁷, S. Monaco⁸, M. Calabrese⁹, R. Reynolds¹⁰, R. Magliozzi¹¹

¹Dept. of Neurological and Movement Sciences, University of Verona, Verona, Italy, ²University of Pennsylvania, Philadelphia, USA, ³Center for Neuroinflammation and Experimental Therapeutics and the Department of Neurology, Perelman School of Medicine, University of Pennsylvania, Philadelphia, USA, ⁴Swansea University, Institute of Life Sciences, Swansea, United Kingdom, ⁵Neurology Section of Dept. of Neurological and Movement Sciences, University of Verona, Verona, Italy, ⁶McGill University, Montreal, Canada, ⁷Imperial College, London, United Kingdom, ⁸Verona, Italy, ⁹University of Verona, Verona, Italy, ¹⁰Faculty of Medicine, Imperial College London, London, United Kingdom, ¹¹Department of Neurosciences, University of Verona, Verona, Italy

Background and aims: Cortical gray matter (GM) damage contributes to multiple sclerosis (MS) progression and exhibits a 'surface-in' gradient, associated with meningeal tertiary lymphoid-like structures (TLS). We studied the pathology of thalamus, a subcortical GM structure early involved in MS.

Methods: Thalamic medial nuclei from 41 post-mortem secondary progressive MS (SPMS) cases were evaluated by immunohistochemistry for demyelinating activity. NeuN+ neurons, MHC-class II+ microglia/macrophages, CD3+T and CD20+ B-cells were counted in 10 SPMS cases with TLS, 10 without TLS and 8 controls. Microglial phenotypes and sub-ependymal infiltrates were further characterized and neurofilament light chain (NfL) levels measured in paired CSF.

Results: Active demyelination was observed in 40% of thalamic lesions (TL). Microglia density was increased near sub-ependymal surface (83% in TL vs Ctrl; 66% in normal appearing thalamus, NAT, vs Ctrl) and reduced in the most internal layers (42% in TL; 17% in NAT). Neuron density was decreased, with a gradient from the sub-ependymal surface (42% in TL vs Ctrl; 28% in NAT vs Ctrl) towards inner regions (20% in TL; 9% in NAT). The gradient was higher in cases with TLS. CSF-NfL levels reflected this gradient. Microglia was markedly activated closely to CSF (TMEM119+ cells). Sub-ependymal infiltrates in cases with TLS had higher number of B-cells, clustered with Ig+ plasma cells and CD35+ follicular dendritic cells.

Conclusion: A gradient of microglial activation and neuronal loss characterizes TL and NAT in SPMS. This associates with presence of TLS, providing evidence for intrathecal inflammation as major driver of subcortical GM damage in MS.

Disclosure: Nothing to disclose

EPR2140

Safety of satralizumab based on pooled data from phase 3 studies in patients with neuromyelitis optica spectrum disorder (NMOSD)

B.G. Greenberg¹, J. De Seze², E. Fox³, A. Saiz⁴, T. Yamamura⁵, C. Marcillat⁶, X. Kou⁶, K. Weber⁶, B.G. Weinshenker⁷

¹University of Texas Southwestern Medical Center, Dallas, United Arab Emirates, ²Hôpital de Hautepierre, Strasbourg, France, ³Central Texas Neurology Consultants, Round Rock, USA, ⁴Hospital Clinic and Institut d'Investigació Biomèdica August Pi i Sunyer (IDIBAPS), Barcelona, Spain, ⁵Department of Immunology, National Institute of Neuroscience, National Center of Neurology and Psychiatry, Tokyo, Japan, ⁶F. Hoffmann-La Roche Ltd, Basel, Switzerland, ⁷Mayo Clinic, Rochester, USA

Background and aims: Satralizumab reduced NMOSD relapse risk in 2 phase 3 studies: SAKuraSky (satralizumab in combination with baseline immunosuppressants; NCT02028884), and SAKuraStar (satralizumab monotherapy; NCT02073279). We evaluated the safety of satralizumab vs placebo across both SAKura studies.

Methods: SAKuraStar and SAKuraSky are randomized studies, consisting of a double-blind (DB) period (satralizumab 120mg Q4W vs placebo) followed by an open-label extension period (satralizumab only). The combined DB/extension period was defined as the overall satralizumab treatment (OST) period (cut-off 7 June 2019). Safety was evaluated in the DB and OST periods using adverse event (AE) rates per 100 patient-years.

Results: The pooled DB population included 178 patients (satralizumab, n=104; placebo, n=74). 166 patients received satralizumab in the OST period. Mean/median satralizumab exposures in the OST period were 133.3 and 128.6 weeks, respectively. Rates of AEs and serious AEs were comparable between treatment groups in the DB period (Table). Infection rates were lower with satralizumab vs placebo, with no increased risk of opportunistic infections (Table). AE, serious AE, and infection rates were comparable between the DB and OST periods (Table). 4 patients (3.8%) on satralizumab and 6 (8.1%) on placebo withdrew from the DB period due to an AE. The injection-related reaction (IRR) rate was higher with satralizumab vs placebo (Table); IRRs were mostly mild-to-moderate and did not lead to treatment discontinuation. No deaths or anaphylactic reactions were reported.

Events/100 PY (95% CI)	Double-blind period		OST period
	Satralizumab (n=104)	Placebo (n=74)	Satralizumab (n=166)
AEs	478.49 (448.18, 510.31)	506.51 (463.38, 552.59)	418.79 (399.83, 438.41)
Serious AEs	14.97 (10.02, 21.50)	17.98 (10.66, 28.42)	12.57 (9.47, 16.36)
Infections	113.04 (98.56, 129.04)	154.85 (131.43, 181.24)	112.41 (102.69, 122.79)
Serious infections	4.13 (1.78, 8.14)	6.99 (2.81, 14.41)	3.88 (2.26, 6.22)
Injection-related reactions	17.03 (11.73, 23.92)	8.99 (4.11, 17.07)	12.11 (9.07, 15.84)

AE, adverse event, OST period, overall satralizumab treatment period; PY, patient year

Table – Pooled adverse event rates across the SAKuraSky and SAKuraStar trials

Conclusion: In patients with NMOSD, satralizumab was well tolerated and showed a favourable safety profile. The long-term OST data were consistent with the DB periods.

Disclosure: Funded by Chugai Pharmaceutical Co. A member of the Roche Group; ClinicalTrials.gov, NCT02028884/NCT02073279; writing and editorial assistance was provided by ApotheCom, UK.

EPR2141

Neurofilament light chain levels in patients with inflammatory demyelinating conditions associated with antibodies to myelin oligodendrocyte glycoprotein (MOG-Abs)

S. Mariotto¹, S. Ferrari¹, D. Alberti², S. Zanzoni³, K. Schanda⁴, S. Monaco¹, M. Reindl⁵, A. Gajofatto²
¹Verona, Italy, ²Department of Neuroscience, Biomedicine and Movement, University of Verona, Italy, ³Centro Piattaforme Tecnologiche, University of Verona, Italy, ⁴Clinical Department of Neurology, Medical University of Innsbruck, Austria, ⁵Neurology, Medizinische Universität Innsbruck, Innsbruck, Austria

Background and aims: Neurofilament light chain (NfL) is a marker of axonal injury, increased in serum/CSF of patients with several neurological disorders in correlation with clinical and radiological activity.

Objective of our study was to assess NfL concentration in patients with MOG-Ab-associated conditions according to clinical/paraclinical characteristics and to evaluate intraindividual changes over time.

Methods: Sera and available (n=17) CSF samples of 63 consecutive MOG-Ab-positive patients tested using a live cell-based assay were analysed for NfL using SIMOA Nf-light kit (SR-X analyser). 60 follow-up samples of 28 patients were also analysed. Clinical and radiological data at sampling and at last follow-up were collected in each case.

Results: We observed a moderate correlation between serum NfL values and age at sampling, with higher levels detected in older patients (rs=0.41, p<0.001). The correlation between paired serum/CSF values (rs=0.42, p=0.09) and between serum MOG-Ab titer and serum NfL levels (rs=0.15, p=0.11) did not reach statistical significance. CSF only MOG-Ab positive cases had higher CSF NfL levels in comparison with seropositive ones. Interestingly, NfL concentration correlated with disability at sampling (rs=0.43, p=0.001) but did not differentiate monophasic and relapsing cases. When analysing follow-up samples, NfL levels decreased (n=30) or remained stable (n=23) in comparison with 1st measurement in most cases, including those on relapse, in parallel with a decrease of clinical disability in comparison with 1st event.

Conclusion: NfL could be a potential biomarker of neurological disability in MOG-Ab positive patients. Future prospective studies will clarify their role in the clinical practice.

Disclosure: Nothing to disclose

EPR2142

Common Pathways of Disease-Modifying Therapies in Patients With Newly Diagnosed Multiple Sclerosis

R. Fox¹, R. Mehta², T. Pham², J. Park³, K. Wilson³, M. Bonafede³

¹Mellen Centre for Treatment and Research in Multiple Sclerosis, Neurological Institute, Cleveland Clinic, Cleveland, OH, USA, ²Bristol-Myers Squibb, Summit, USA, ³IBM Watson Health, Cambridge, USA

Background and aims: Several disease-modifying therapies (DMTs) have been available for the treatment of multiple sclerosis (MS) in the past decade. This study describes the most common pathways of DMT treatment used by US patients with newly diagnosed MS.

Methods: Newly diagnosed MS adults were identified from January 2007 to October 2017 in the US-based IBM MarketScan Commercial and Medicare databases. Patients had at least 1 year of continuous enrolment prior to their initial MS diagnosis. DMT pathways were assessed for up to 3 lines of therapy (LOTs) during a follow-up period of 2 to 10.5 years.

Results: Of 29,647 patients with at least 2 years of follow-up from MS diagnosis, 14,627 were treated with DMTs. Overall, 49% had 1 DMT LOT during follow-up, 25% had 2 DMT LOTs, and 27% had 3 DMT LOTs. Many DMT pathways were observed, and glatiramer acetate (GA) was the most common with 40% of patients initiating GA: 19.4% had 1 GA cycle only, 4.7% had 2 cycles, and 5.9% had 3 cycles. Intramuscular interferon beta-1a (IFNβ-1a) was the 2nd most common pathway (10.2%) followed by subcutaneous IFNβ-1a (6.3%). Use of other DMTs such as dimethyl fumarate and fingolimod increased from 1st LOT to 2nd LOT, while use of GA, IFNβ-1a, and interferon beta-1b decreased.

Conclusion: GA and IFNβ-1a were the most common DMT pathways among MS patients in this US pharmacy benefits database. Oral therapies were used more commonly as second or 3rd therapies, although they only became available partway through the period of study.

Disclosure: Robert Fox: Actelion, Biogen, Celgene, EMD Serono, Genentech, Immunic, Novartis, Sanofi, Teva, and TG Therapeutics – personal consulting fees; Actelion, Biogen, Immunic, and Novartis – advisory committee; Biogen and Novartis – clinical trial contract and research grant funding. Rina Mehta and Tim Pham: Bristol-Myers Squibb – employment. Julie Park, Kathleen Wilson and Machaon Bonafede: IBM Watson Health – employment.

EPR2143

Human papillomavirus infections in patients suffering from relapsing remitting multiple sclerosis under fingolimod

E. Mhanna¹, V. Pourcher², C. Louapre³, C. Lubetzki⁴, C. Papeix⁴, E. Maillart⁵

¹Paris, France, ²Service des maladies infectieuses, Pitié Salpêtrière, Paris, France, ³ICM, Paris, France, ⁴Department of Neurology, Pitié-Salpêtrière hospital, Paris, France, ⁵Aphp, Paris, France

Background and aims: Fingolimod (Fg) is an immunosuppressive drug used in the treatment of Relapsing remitting multiple sclerosis (RRMS) available in France since 2012. In 2018, HPV infections have been reported in patients treated with fingolimod. We aim to describe a series of cases of HPV lesions (location, treatment and prognosis) under fingolimod.

Methods: This is a cohort of 14 RRMS patients followed at Pitié-Salpêtrière. Clinical data were collected retrospectively for the MS evolution, and prospectively for clinical characteristics, treatment of HPV lesions and MS therapeutic strategy after HPV diagnosis

Results: We report 14 patients (9 women) in whom HPV lesions were diagnosed under fingolimod with no prior records of HPV disease. At the moment of diagnosis they were aged 35 yo (±6), on fingolimod for 3.17 years (±2.1), with a mean MS evolution of 13.6 years (±6.4). Lesions were genital (85.7%), cutaneous (21.4%) or anal (14.3%). Treatment with fingolimod was discontinued in 4 patients.

Conclusion: HPV infection, transmitted via direct contact and increased in immunocompromised patients, can cause gynecological and ENT cancers. The prevalence of these lesions under fingolimod is underestimated. A systematic dermatological and gynecological follow up are required to screen for precancerous lesions before and during treatment. Anti HPV vaccine might be discussed case by case. Systematic prevention and screening of HPV lesions in RRMS patients under fingolimod are necessary to avoid HPV-associated neoplasia.

Disclosure: Nothing to disclose

EPR2144

Early Retirement and MS on the UK MS Register

R. Middleton¹, E. Craig², K. Tuite-Dalton², M. Dvorak², D. Ford², R. Nicholas³

¹Swansea, United Kingdom, ²Medical School, Swansea University, Swansea, United Kingdom, ³Imperial College, London, United Kingdom

Background and aims: Multiple Sclerosis (MS), a chronic degenerative disease typically diagnosed in a patient's early 30s, it profoundly impacts disability and socio-economic status. In the 'healthy population, the rate of medical retirement is ~3%. We compared this retirement rate with population of the UK MS Register (UKMSR).

Methods: We examined the UKMSR population (aged ≥18, confirmed diagnosis of MS) that completed the demographic questionnaire about employment.

Results: 11,277 people with MS (pwMS) fitted the criteria, 2194 declared themselves as retired (19%). Mean age for retirees was 65.7±8.6 years (mean±standard deviation), compared to 50.1±10.3 years in non-retirees. 70.1% of retirements were due to a medical condition; 448 aged <60; 50% of the retired group declared an EDSS ≥ 6.5, compared to 34% in the overall population. There was a higher proportion of pwMS diagnosed with Secondary Progressive MS (SPMS) in the retired group (15.4%) compared to the overall population (6.0%), and a higher proportion whose current disease type was SPMS (36.6% compared to 18.4%). 78.8% of retirees had previously worked in Managerial, Professional or Administrative roles – higher than the 65.6% of the rest of the portal.

Conclusion: A significant proportion of the UKMSR population retires earlier than the general population. Their disability levels are also higher than the rest of the UKMSR and they have higher rates of progressive MS at diagnosis. Those retirees are in professions that would nominally appear to support them in continuing to work – perhaps with appropriate aids/breaks.

Disclosure: Nothing to disclose

EPR2145

Lifestyle and adherence to the Mediterranean diet within a Southern Italy cohort of Patients with Multiple Sclerosis

G. Miele¹, S. Esposito², M. Sparaco¹, G. T. Maniscalco³, R. Lanzillo⁴, C.V. Russo⁴, E. Signoriello¹, S. Cepparulo¹, L. Lavorgna², A. Signori⁵, L. Carmisciano⁵, F. Sacca⁴, S. Bonavita¹

¹University of Campania Luigi Vanvitelli, Naples, Italy,

²Department of Medical, Surgical, Neurological, Metabolic and Aging Sciences, Second University of Naples, Naples, Italy, ³Division of Neurology, Naples, Italy, ⁴Department of Neurosciences, Reproductive Science and Odontostomatology, Federico II University, Naples, Italy,

⁵University of Genoa, Genoa, Italy

Background and aims: The role of diet on Multiple Sclerosis (MS) has not been comprehensively elucidated. The objectives of the study are to: 1) Describe Lifestyle and dietary behaviours of a cohort of Southern Italy patients with MS; 2) Analyze their adherence to the Mediterranean Diet (MeDi) and its impact on MS.

Methods: We enrolled 435 patients. All participants underwent a clinical examination, updating disease phenotype, Expanded Disability Status Scale (EDSS), Multiple Sclerosis Severity Score (MSSS), ongoing disease-modifying therapy, and comorbidities. We collected biometric parameters and life and dietary habits, following the Med Diet Score (MDS). Higher values of MDS indicate a greater adherence to the MeDi. Face-to-face interviews were conducted. The questionnaire consisted of 29 items.

Results: 81.3% showed relapsing-remitting phenotype. At survey time, 72.8% of respondents were no smokers. 52.9% declared to regularly perform physical activity, 75.8% stated to be interested in nutrition and 45.6% used food supplements.

There was no significant heterogeneity in adherence to the MeDi in relation to socio-demographic and clinico-radiological features. To explore the influence of the MeDi on disease course, a multivariate linear regression analysis was performed to analyze the relationship between MDS and MS clinical measures. Significant inverse correlation between MDS and both MSSS ($\beta=-0.04$, $p=0.015$) and EDSS ($\beta=-0.03$, $p=0.014$), at survey time, were found (table 1).

	Median	IQR	Correlation with MDS	
			R	p
EDSS (baseline)	2.0	1.5 - 3.0	-0.09	0.055 ₁
	Median	IQR	Correlation with MDS	
			B	p
MSSS (at survey time)	2.8	1.3 - 4.9	-0.04	0.015*
EDSS (at survey time)	2.5	1.5 - 4.0	-0.03	0.014*

Table 2. A multivariate linear regression to analyze the relationship between MDS and MS clinical measures. Data were adjusted for sex, age, disease duration, ARR 1 year before baseline, disease phenotype, radiological and therapeutic features.

Table 1. A multivariate linear regression to analyze the relationship between MDS and MS clinical measures. Data were adjusted for sex, age, disease duration, ARR 1 year before baseline, disease phenotype, radiological and therapeutic features.

Conclusion: The dietary behavior influences disease outcomes of long term disability (EDSS, MSSS). Since neurodegeneration is associated to microinflammation the diet influencing low-grade chronic systemic inflammation, may impact on disease progression.

Disclosure: Nothing to disclose

EPR2146

Alemtuzumab-induced thyroid disease: observational data from an Italian cohort of patients

L. Moiola¹, A. Nozzolillo², L. Di Filippo³, C. Zanetta⁴, M. Manzoni³, C. Lapucci⁵, A. Laroni⁵, M. Mirabella⁶, A. Bianco⁷, V. Brescia Morra⁸, R. Lanzillo⁸, C.V. Russo⁹, M. Margoni¹⁰, F. Rinaldi¹¹, M. Zaffaroni¹², F. Patti¹³, C.G. Chisari¹³, P. Cavalla¹⁴, M. Vercellino¹⁴, E. Cocco¹⁵, J. Frau¹⁵, M. Capobianco¹⁶, A. Bertolotto¹⁶, S. Malucchi¹⁶, A.R. Pia¹⁷, G. Comi¹, M. Filippi¹

¹Department of Neurology and INSPE, Ospedale San Raffaele - Vita-Salute San Raffaele University, Milan, Italy,

²Federico II University, Naples, Italy, ³Endocrine and Metabolic Disorders Unit, IRCCS San Raffaele Hospital, Milan, Italy, ⁴Milan, Italy, ⁵IRCCS Ospedale San Martino, Genoa, Italy, ⁶Neurology, Catholic University School of Medicine, Rome, Italy, ⁷Rome, Italy, ⁸Naples, Italy,

⁹Department of Neurosciences, Reproductive Science and Odontostomatology, Federico II University, Naples, Italy,

¹⁰Padua, Italy, ¹¹Department of Neurosciences, Neurology Clinic, Padua, Italy, ¹²Gallarate, Italy, ¹³CATANIA, Italy,

¹⁴Turin, Italy, ¹⁵Cagliari, Italy, ¹⁶Orbassano, Italy,

¹⁷SS Endocrinologia, Dipartimento di Scienze Cliniche e Biologiche, Dipartimento di Scienze Cliniche e Biologiche, Azienda Ospedaliera Universitaria, San Luigi Gonzaga, Orbassano (TO), Italy, Orbassano, Italy

Background and aims: Patients treated with Alemtuzumab are at the risk of developing secondary autoimmunity, mainly alemtuzumab-induced-thyroid disease (AITD), which occurs in 17-34% of cases and develops after 6 months following the 1st course, with a peak incidence after 3 years. AITD is a dynamic spectrum of diseases. The aim of this work is to describe AITD clinical presentation, evolution and management in a cohort of Italian Alemtuzumab treated-patients.

Methods: Data were collected from 10 Italian MS centers. Globally, 542 patients were treated between 2015-2019. Thyroid function tests (TF) were performed prior to drug administration and every 3 months.

Results: 98 (18.17%) patients developed AITD, mainly GD (48.27%), with a median onset 16 months after the last dose. In particular, 19,29% had AITD in the 1st year after 1st dose, 51.21% within the 1st and 2nd year and 30.5% after 2 years or more. The majority of AITD were quite easily resolved with a conservative approach, however, in a minority of cases, a fluctuating course developed, with a quick shift from hyperthyroidism to hypothyroidism and vice versa, hard to manage with medical therapy.

Conclusion: AITD incidence is expected to increase over time. A further increase in AITD has not yet emerged after two years due to a low proportion of patients with a longer follow-up. Based on our experience and in line with current recommendations, a strict thyroid-function monitoring prior and after alemtuzumab is fundamental, in order to detect and treat AITD promptly and have favorable outcomes.

Disclosure: LM has received compensation for speaking activities, and/or consulting services from Merck, Biogen, Novartis, Roche, Sanofi, and TEVA.

EPR2147

Pre-treatment with Natalizumab Reduces Risk of Alemtuzumab-Associated Secondary B-Cell Autoimmunities

T. Moser¹, K. Akgün², U. Proschmann³, J. Sellner⁴, T. Ziemssen⁵

¹Salzburg, Austria, ²Neurology, University Hospital Carl Gustav Carus, Dresden, Germany, ³Carl Gustav Cars Universität, Dresden, Germany, ⁴Department of Neurology, Christian Doppler University Hospital - Landesnervenklinik Salzburg, Salzburg, Austria, ⁵Dresden, Germany

Background and aims: Alemtuzumab (ALEM) carries a substantial risk for secondary b-cell-mediated autoimmunities (sAI). Hyperrepopulation of immature B-cells following administration is considered the substrate of sAI. Natalizumab (NAT) hampers the transmigration of lymphocytes into the brain but also shifts precursor B-cells, including autoreactive clones, from the bone marrow to the peripheral circulation, potentially making them a substrate for consequent ALEM depletion. We therefore hypothesise, that pre-treatment with NAT could prevent ALEM associated B-cell hyperrepopulation and sAI.

Methods: We included 17 patients with multiple sclerosis switched from NAT to ALEM (NAT-ALEM cohort) and compared cell-surface and intracellular marker from peripheral blood mononuclear cells (PBMCs) measured by FACS to either a control cohort of 16 (natalizumab “naïve”) ALEM patients (nALEM cohort) or to the depletion rates from the CARE-MS-I.

Results: NAT-ALEM patients had significantly increased (naïve) B-cell frequencies at ALEM start (baseline, BL) compared to nALEM controls. After 12 months, CD19+ cells and naïve B-cells did not reach BL levels (-30%, -6% respectively) in the NAT-ALEM group, whereas they fully recovered in the nALEM group (+9%, +32% respectively). Moreover, the recovery rates of immature B-cells at month 12 showed a discrepancy of about 120% (-31% vs. +90% in the CARE-MS-I study population). Most impressively, only 2/17 (11,8%) NAT-ALEM patients developed sAI, in contrast to 50% in the control cohort.

Conclusion: We show that pre-treatment with NAT appears to substantially lower the incidence of ALEM-associated secondary autoimmunities, most likely by making precursor B-cells, including autoreactive clones, accessible to a subsequent CD52 depletion.

Disclosure: Tobias Moser received financial support by the austrian society of neurology (ÖGN).

EPR2148

TH17 Abundance Predicts Disease Reactivation after Natalizumab Withdrawal

T. Moser¹, K. Akgün², U. Proschmann², J. Sellner¹, T. Ziemssen²

¹Department of Neurology, Christian Doppler University Hospital - Landesnervenklinik Salzburg, Salzburg, Austria, ²Neurology, University Hospital Carl Gustav Carus, Dresden, Germany

Background and aims: Multiple sclerosis (MS) is an autoimmune disorder of the central nervous system, driven by an imbalance of inflammatory and regulatory immune cell subsets. However, the exact pathogenesis remains to be further elucidated. Here, we aimed to investigate the immunological signature of patients with reactivated disease after natalizumab discontinuation as compared to stable patients in order to define immunological markers for disease reactivation.

Methods: 26 patients switched from natalizumab (NAT) to fingolimod (FTY) were included in this study and divided into 2 groups depending on disease reactivation. We analysed peripheral blood mononuclear cells (PBMCs) by fluorescence- activated cell scanning (FACS) for various cell-surface and intracellular markers at timepoints 0 (baseline, just before FTY start) and months 1, 3, 6 and 12. The mean NAT wash-out phase was 11.4 weeks.

Results: 10 patients (38%) showed radiological or clinical disease activity in the 12 months observational period after switching to FTY. We found significant correlations between disease reactivation and frequency of TH17 cells. Interestingly, the 2 important regulatory subsets of the TH17 pathways, namely CD39+ regulatory T-cells (Tregs) and CD27+ natural killer (NK) cells, were significantly reduced. On the other hand, we found no associations between disease activity and TH1 cells, memory B-cells, as well as with the conventional regulatory subsets.

Conclusion: Active MS is strongly correlated with an imbalance of proinflammatory TH17 cells and their regulatory counterparts. Measuring TH17 pathways appears to be a proper monitoring tool for disease activity. Also, the inhibiting role of CD27+NK cells in MS deserves further attention.

Disclosure: Tobias Moser has received a research grant by the Austrian Society of Neurology (ÖGN).

EPR2149

Pharmacokinetic/pharmacodynamic properties of eculizumab support established efficacy in patients with NMOSD: findings from the phase 3 PREVENT study

A. Berthele¹, C. Oreja-Guevara², J. Palace³, D. Wingerchuk⁴, S.J. Pittock⁵, M. Levy⁶, I. Nakashima⁷, P. Singh⁸, X. Gao⁸, R. Pelto⁹, K. Fujihara¹⁰
¹Klinikum rechts der Isar, Technical University of Munich, Munich, Germany, ²Hospital Universitario Clínico San Carlos, Madrid, Spain, ³John Radcliffe Hospital, Oxford, United Kingdom, ⁴Mayo Clinic, Scottsdale, USA, ⁵Mayo Clinic, Rochester, USA, ⁶Massachusetts General Hospital and Harvard Medical School, Boston, USA, ⁷Division of Neurology, Tohoku Medical and Pharmaceutical University, Sendai, Japan, ⁸Alexion Pharmaceuticals, Boston, USA, ⁹Alexion Pharmaceuticals, New Haven, USA, ¹⁰Fukushima Medical University, Fukushima City, Japan

Background and aims: During PREVENT (NCT01892345), patients with aquaporin-4 immunoglobulin G-positive neuromyelitis optica spectrum disorder who received eculizumab (n=96) had significantly lower risk of relapse than placebo (n=47). Eculizumab was EMA-approved in August 2019 for this indication.

Methods: The eculizumab group received intravenous 900mg/week for 4 weeks, followed by 1200mg² weeks (maintenance dose). Serum eculizumab concentration was measured by ELISA with lower limit of quantification (LLOQ) 9.38µg/mL. The target for complete complement inhibition was >116µg/mL. Serum free C5 concentration was measured by ELISA with LLOQ 0.027µg/mL; <0.5µg/mL represented complete complement inhibition. Haemolytic activity was measured using percentage chicken red blood cell (%cRBC) haemolysis semi-quantitative assay; <20% represented complete inhibition. Patients with ≥1 time-matched pharmacokinetic and pharmacodynamic measurement were included in the analysis. Trough/peak measurements were recorded. Cerebrospinal fluid (CSF) analysis was available for a subset of patients.

Results: After the 1st dose, mean serum eculizumab concentration was 359µg/mL (Figure 1); 813/841 (96.7%) of subsequent trough samples were >116µg/mL. Mean serum free C5 concentration dropped from 128µg/mL to 1.1µg/mL (Figure 2) and was <0.5µg/mL in 93/94 (98.9%) patients; 832/838 (99.3%) of subsequent trough samples were <0.5µg/mL. Mean haemolytic activity was reduced from 91.3% to 2.26% cRBC haemolysis (Figure 3); 815/834 (97.7%) of subsequent trough samples were <20%. CSF data from eight patients supported serum observations.

Figure 1. Mean serum eculizumab trough and peak concentrations during PREVENT

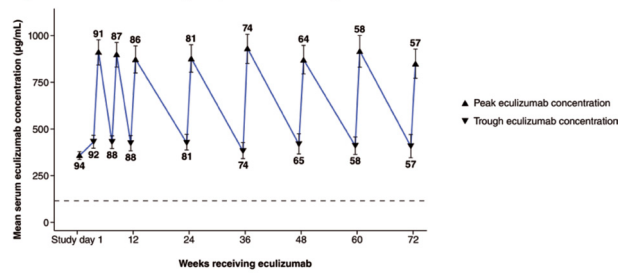

The numbers in bold represent the number of PK samples at each visit. Study day 1 trough value not shown was < LLOQ. Horizontal dotted line indicates target concentration of 116 µg/mL. Error bars represent 95% confidence intervals based on standard error of the mean. Only samples from scheduled visits from patients in the eculizumab group are shown. Eculizumab concentrations below the LLOQ (9.38 µg/mL) from samples after first eculizumab dose were analysed as 0.5 × LLOQ. Two trough (pre-dose) study day 1 samples with > LLOQ concentration were excluded. Of the 96 eculizumab-treated patients, no PK data were available for one patient. PK, pharmacokinetic; LLOQ, lower limit of quantification.

Figure 2. Mean serum free C5 concentrations at eculizumab trough and peak during PREVENT

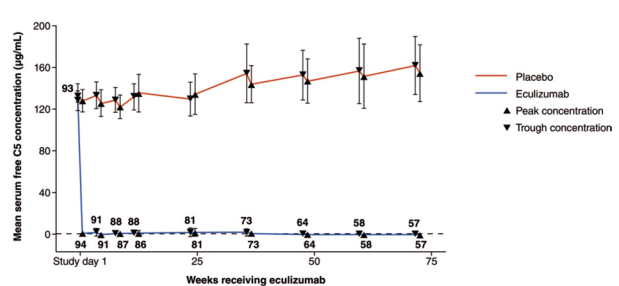

The numbers in bold represent the number of free C5 samples in the eculizumab group at each visit. Horizontal dotted line indicates 0.5 µg/mL (< 0.5 µg/mL represents complete inhibition). Peak (post-dose) study day 1 mean was > 0.5 µg/mL, owing to one high free C5 value from a patient with a corresponding serum eculizumab sample concentration < LLOQ. Error bars represent 95% confidence intervals based on standard error of the mean. Only samples from scheduled visits are shown. Free C5 concentrations below the LLOQ (0.027 µg/mL) from samples after first eculizumab dose were analysed as 0.5 × LLOQ. Two trough (pre-dose) study day 1 samples with serum eculizumab concentration < LLOQ were excluded. Of the 96 eculizumab-treated patients, no free C5 data were available for one patient. C5, complement component 5; LLOQ, lower limit of quantification.

Figure 3. Mean percentage haemolysis activity (percentage cRBC haemolysis) at eculizumab trough and peak during PREVENT

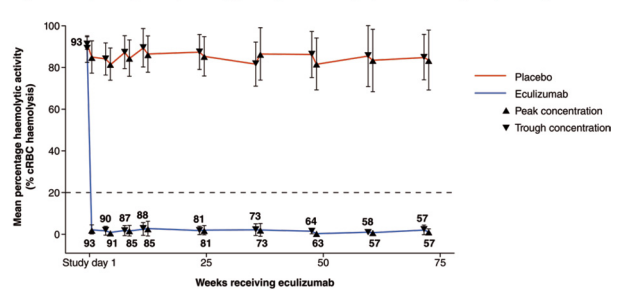

The numbers in bold represent the number of haemolysis samples in the eculizumab group at each visit. Horizontal dotted line indicates 20% cRBC haemolysis (< 20% represents complete inhibition). Error bars represent 95% confidence intervals based on standard error of the mean. Only samples from scheduled visits are shown. Two trough (pre-dose) study day 1 samples with serum eculizumab concentration > LLOQ were excluded. Of the 96 eculizumab-treated patients, no haemolysis data were available for one patient. cRBC, chicken red blood cell; LLOQ, lower limit of quantification.

Conclusion: Serum eculizumab was maintained at >116µg/mL, resulting in rapid, complete and sustained inhibition of serum free C5 (<0.5µg/mL) and haemolytic activity (<20% cRBC haemolysis) for most samples. Pharmacokinetic/pharmacodynamic data corroborate reduced risk of relapse with eculizumab during PREVENT.

Disclosure: Research funding for this study was provided by Alexion Pharmaceuticals.

Muscle and neuromuscular junction disease 2

EPR2150

Paraneoplastic and non paraneoplastic Lambert-Eaton Myasthenic Syndrome: a retrospective descriptive study

A. Laurence, T. Maisonobe, D. Psimaras, T. Lenglet
Groupe hospitalier Pitié-Salpêtrière, Paris, France

Background and aims: Clinical and electrophysiological characteristics that allow to distinguish paraneoplastic (PN) Lambert-Eaton myasthenic syndrom (LEMS) from non PN are largely unknown. The aim of this study is to describe the electrophysiological triad of LEMS on different nerve/muscle couples and to compare these characteristics between PN and non PN LEMS.

Methods: We retrospectively analyzed the electrophysiological data (compound muscle action potential (CMAP) amplitude at rest, decrement at 3Hz stimulation, increment after brief exercise) from the 19 LEMS diagnosed at Pitié Salpêtrière from January 2009 to December 2019. We compared characteristics of the 11 PN LEMS with the 7 non PN LEMS (the remaining diagnostic assessments being unavailable).

Results: Median/abductor pollicis brevis (M/APB) and ulnar/abductor digiti quinti (U/ADQ) were the most often altered couples (decrement in 100% resp. 86.4% of cases, increment in 100% resp. 89.3% of cases). The decrement worsened after the 5th stimulation in 63.3% of cases. The CMAP amplitude was most often decreased for PN LEMS (93.2% vs 69.4%). A decrement at 3Hz stimulation was most frequent for PN LEMS (78.1% vs 53.2%), as well as an increment after brief exercise (84.1% vs 59.4%).

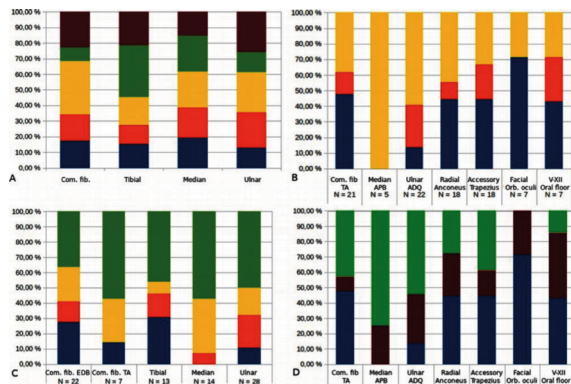

Figure 1. Electrophysiological data according to the nerve/muscle couple for the whole cohort
A: Compound muscle action potential (CMAP) amplitude at rest at diagnosis according to the nerve/muscle couple. Blue: Normal (N); Orange: [0,5N – N]; Yellow: [0,2N – 0,5N]; Green: [0,1N – 0,2N]; Brown: < 0,1N
B and D: Severity (B) and pattern (D) of the decremental response at 3Hz stimulation at diagnosis according to the nerve/muscle couple. Blue: no significant decrement; Orange: decrement of 10 to 20%; Yellow: decrement > 20%; Brown: decrement that does not worsen after the 5th stimulation, in “U”; Green: progressive decrement, that keeps worsening after the 5th stimulation
C: Increment after brief exercise at diagnosis according to the nerve/muscle couple. Blue: no significant increment; Orange: Increment of 60 to 100%; Yellow: Increment of 100 to 200%; Green: Increment > 200%
 Com. fib.: Common fibular; TA: Tibialis anterior; APB: Abductor pollicis brevis; ADQ: Abductor digiti quinti; Orb. oculi: Orbicularis oculi; EDB: Extensor digitorum brevis

Figure 1: Electrophysiological data according to the nerve/muscle couple for the whole cohort

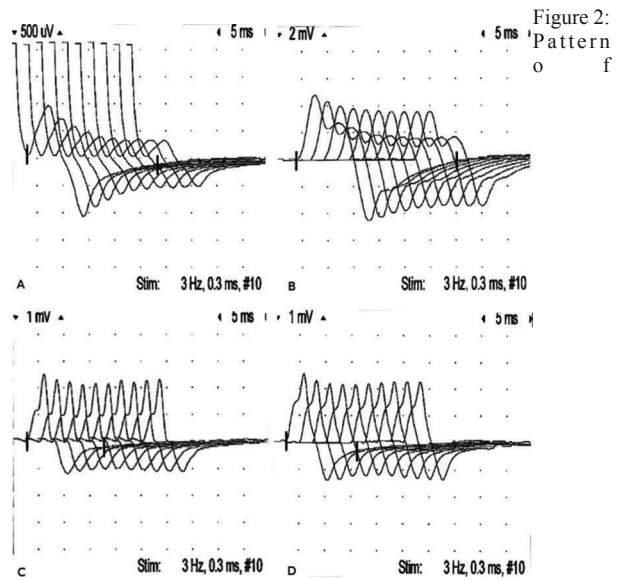

Figure 2. Pattern of decremental response at 3Hz repetitive stimulation
A and B: Progressive decrement, that keeps worsening after the 5th stimulation A: Ulnar/abductor digiti quinti; B: Common fibular/tibialis anterior
C and D: Decrement in “U”, that does not worsen after the 5th stimulation. Ulnar/abductor digiti quinti of other patients

decremental response at 3Hz repetitive stimulation

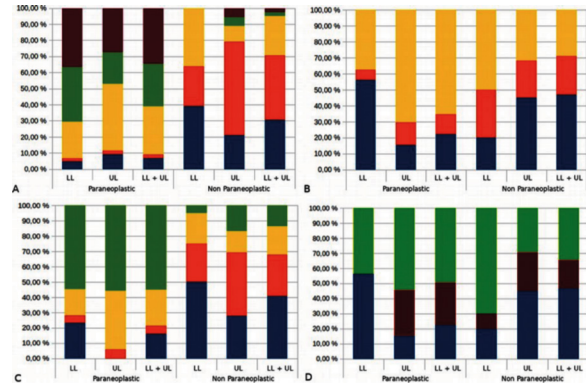

Figure 3. Comparison of electrophysiological data between paraneoplastic and non paraneoplastic Lambert-Eaton Myasthenic Syndrome

A: Compound muscle action potential (CMAP) amplitude at rest at diagnosis according to the limb. Blue: Normal (N); Orange: [0,5N – N]; Yellow: [0,2N – 0,5N]; Green: [0,1N – 0,2N]; Brown: < 0,1N
B and D: Severity (B) and pattern (D) of the decremental response at 3Hz stimulation at diagnosis according to the limb. Blue: no significant decrement; Orange: decrement of 10 to 20%; Yellow: decrement > 20%; Brown: decrement that does not worsen after the 5th stimulation, in “U”; Green: progressive decrement, that keeps worsening after the 5th stimulation
C: Increment after brief exercise at diagnosis according to the limb. Blue: no significant increment; Orange: Increment of 60 to 100%; Yellow: Increment of 100 to 200%; Green: Increment > 200%
 LL: Lower Limb; UL: Upper Limb; Global: LL + UL + Face

Figure 3: Comparison of electrophysiological data between paraneoplastic and non paraneoplastic Lambert-Eaton Myasthenic Syndrome

Conclusion: The M/APB and U/ADQ couples are particularly sensitive for the diagnostic of LEMS. The electrophysiological pattern of PN LEMS seems to be more severe as non PN, for CAMP amplitude as well as decrement and increment. If confirmed in a validation cohort, the severity of the electrophysiological picture could be included in a prediction score of PN LEMS.

Disclosure: Nothing to disclose

EPR2151

Efgartigimod in Myasthenia Gravis: Phase 3 Trial Design

J.F. Howard Jr¹, H. De Haard², W. Parys², P. Ulrichs², A. Guglietta², R.E. Mantegazza³

¹*Dept of Neurology, University of North Carolina, Chapel Hill, USA*, ²*R & D, argenx BVBA, Ghent, Belgium*, ³*Milan, Italy*

Introduction: Myasthenia gravis (MG), an autoimmune disease causing debilitating muscle weakness, is mediated by IgG autoantibodies. Neonatal Fc receptor (FcRn) recycles IgG extending its half-life. Efgartigimod, a human IgG1 antibody Fc-fragment engineered for optimal blocking of FcRn, outcompetes endogenous IgG-binding, prevents IgG recycling, reducing IgG and autoantibody levels.

Methods: This 26-week, randomised double-blind, placebo-controlled Phase 3 trial of efgartigimod evaluates efficacy, safety, and quality of life in patients (age >18 years) diagnosed with generalized MG class II, III, and IV on stable concomitant standard of care MG therapy. Inclusion criteria are MG-ADL score of ≥ 5 points (>50% non-ocular). A maximum of 20% of acetylcholine receptor antibody (AChR-Ab) seronegative patients will be allowed in the trial. Following screening, eligible patients receive 4 weekly doses of IV 10mg/kg. Subsequent treatment is tailored according to clinical condition, based on MG-ADL score.

Results: 167 patients enrolled at 51 sites in 15 countries. Efficacy endpoint is the percentage of AChR-Ab seropositive patients whose MG-ADL decreases within the first treatment cycle by at least 2 points from baseline for ≥ 4 consecutive weeks. 2ndary endpoints include additional MG-ADL and QMG assessments.

Conclusion: Efficacy and safety findings will be reported at the conclusion of the trial.

Disclosure: Clinical trial supported by argenx BVBA

EPR2152

Rest or Exercise (RESTOREX) in Myasthenia Gravis: a randomized controlled trial

U.K. Misra¹, J. Kalita¹, V.K. Singh¹, A. Kapoor², A. Tripathi¹, P. Mishra³

¹*NEUROLOGY, Sanjay Gandhi Post Graduate Institute of Medical Sciences, LUCKNOW, India*, ²*Cardiology, Sanjay Gandhi Post Graduate Institute of Medical Sciences, Lucknow, India*, ³*Bio statics, Sanjay Gandhi Post Graduate Institute of Medical Sciences, Lucknow, India*

Background and aims: In Myasthenia Gravis (MG), the effect of exercise is not well known. In this study the efficacy and safety of exercise in MG in comparison to rest is presented

Methods: In this single-center open-labeled randomized clinical trial the patients were randomized to exercise (30min walk) or rest. The Primary endpoint was 50% change in Myasthenia Gravis Quality of Life (MG-QOL15) at 3 months and 2ndary endpoints were change in Myasthenic Muscle Score (MMS), Myasthenia Gravis Activities of Daily Living (MGADL), grip strength, AChEI and prednisone dose, 6 minute walk test (6MWT), decrement in trapezius muscle and adverse events

Results: 20 patients in each arm, were matched for demographic and clinical parameters. The patients in exercise arm had significantly better MG-QOL15 (P=0.02), increase in number of steps (P=0.03) and the distance covered in 6MWT (P=0.003). The scores of MG-QOL15 (P=0.03), MMS (P=0.048), and distance travelled (P<0.001) also revealed significant group difference. Intragroup comparison revealed that both exercise and rest arm significantly improved with respect to MG-QOL15 in exercise (P=0.001) and rest (P=0.001), MMS in exercise (P=0.001) and rest (P=0.001), reduction in pyridostigmine (P=0.03) and prednisone (P=0.001) dose in exercise, increase in number of steps in exercise (P=0.001) and increase in walking distance in 6MWT in both exercise (P=0.001) and rest arm (P=0.023). There was no adverse event in any group

Conclusion: The study provides class II evidence of improved quality of life in mild to moderate MG by 30 min walk compared to rest

Disclosure: Nothing to disclose

EPR2153

AChR antibody positivity rate in ocular myasthenia gravis: a matter of age?

G. Monte, G. Spagni, R. Iorio, A. Evoli
Rome, Italy

Background and aims: Anti-acetylcholine receptor antibodies (AChR Abs) are detected in 85-90% of patients with generalized myasthenia gravis (GMG), with higher positivity rates in late-onset cases. AChR Ab sensitivity is thought to be much lower in ocular MG (OMG), though in a recent study it was as high as 70.9% in association with increasing age of onset.

We hypothesized that, like in GMG, there has been, in the last decades, a shift in OMG age at onset towards a higher prevalence of late-onset cases that may account for increased AChR Ab sensitivity.

Methods: We compared patients with symptom onset before (N=69) and after January 1st, 1998 (N=100). All had purely OMG over a follow-up ≥ 2 years. AChR Ab were tested by radioimmunoassay. Seronegative cases had increased jitter on single fiber-electromyography and/or positive response to neostigmine. Onset age, sex, presence of thymoma, AChR Ab positivity were recorded. The correlation between clinical variables and Ab result was evaluated by multiple logistic regression (MLR) analysis.

Results: Age at onset, male/female ratio and AChR Ab positivity rate were significantly increased in the population with onset in the last 2 decades; thymoma frequency was similar in the 2 series. These data are shown in the table. On MLR analysis the only variable associated with AChR Ab positive result was OMG onset after 50 years-of-age ($p < 0.00001$).

	Onset before 1998 69 patients	Onset since 1998 100 patients	p
Age at onset, years (mean \pm SD)	35.4 \pm 18.69	55.05 \pm 17.68	< 0.00001 [§]
Age at onset \geq 50 years	20/69 (29%)	67/100 (67%)	< 0.0001*
Male/female ratio	39/30 (1.3/1)	76/24 (3.17/1)	0.0115*
Rate of thymoma patients	4/69 (5.8%)	6/100 (6%)	NS*
AChR Ab positivity	36/69 (52%)	73/100 (73%)	0.0086*

[§]Mann-Whitney Test; * Fisher Exact Test; NS = not significant

Table: characteristics of OMG patients

Conclusion: From our results, current AChR Ab sensitivity in OMG may be higher than generally thought. This finding was associated with a rising prevalence of late-onset cases, paralleling epidemiological changes in GMG.

Disclosure: Nothing to disclose

EPR2154

Diagnostic value of NGS in distal myopathies

P. Marti¹, N. Muelas², I. Azorin³, A. Casasus¹,
R. Vilchez¹, J.J. Vilchez¹

¹Neuromuscular, IIS la Fe, Valencia, Spain, ²Neurology,
Hospital Universitario La Fe, Valencia, Spain,

³Neuromuscular, CIBERER, Valencia, Spain

Background and aims: Distal myopathies (DM) are a heterogeneous group of muscle diseases caused by mutations in different genes. The new generation sequencing technology (NGS) has improved the diagnosis, although a proportion of patients remain still undiagnosed.

The objective was to evaluate the efficiency of a NGS approach using a self-costumed panel of neuromuscular genes in patients with DM.

Methods: 75 patients who remained undiagnosed of a series of 125 cases with DM on follow up in a Neuromuscular Unit in the Valencia Country were studied. 35 cases were sequence by PANEL1 (40 genes; Ion Torrent technology) during 2016-2017 and 40 cases were sequence by PANEL2 harboring of 272 genes based on Illumina technology from 2017-2019.

Results: A definitive molecular diagnosis was reached in 45% of the investigated cases, being the frequency of genes as follows: 27% ANO5, 18% TTN, 9% DYSF, 9% MYOT, 6% GNE, 6% HSPB1, 6% MYH7 and a single case was detected of each of these genes: HNRPDL, VCP, COL6A2, BICD2, EMD, NEB and TPM2. A probable diagnosis was obtained in 16% cases, with the following yield: ANO5, TTN, TCAP, DYSF, POLG, CAPN3, COL6A1, BAG3, HNRPDL and LDB3. 39% of the cases remained unsolved.

Conclusion: Our results demonstrated the efficacy of NGS in the diagnosis of DM. This approach is also useful to diagnose atypical phenotypes in DM. However, this procedure provides a large amount of unprocessed data that requires experience and sometimes biological analysis in tissues or cells to confirm the pathogenicity of the variants found.

Disclosure: This research has been granted support by: - Carlos III Research Institute projects: PI11/0203 and PI16/00316 - ISABEL GEMIO FOUNDATION FOR THE RESEARCH OF MUSCLE DYSTROPHIES AND OTHER RARE DISEASES: 2018/0200

EPR2155

The prevalence of inherited neuromuscular disorders in Northern Norway

K.I. Mueller¹, M. Van Gheule², C. Jonsrud³, K.A. Arntzen⁴

¹Tromsø, Norway, ²Department of Medical Genetics, Division of Child and Adolescent Health, University Hospital of North Norway, Tromsø, Norway, Tromsø, Norway,

³Department of Medical Genetics, Division of Child and Adolescent Health, University Hospital of North Norway, Tromsø, Norway, ⁴Kvaløysletta, Norway

Background and aims: Epidemiological studies on inherited neuromuscular disorders are important to plan for better health care services. In this study, we aim to investigate the point prevalence of inherited neuromuscular disorders in Northern Norway.

Methods: This study was based on patient registries and electronic patient records, and performed in Northern Norway, with a point prevalence estimated for 10th October 2019

Results: We identified 539 patients, giving a total point prevalence of 110.8/100,000 (95%CI 101.8–120.6). The prevalence of children (<18 years old) and adults (≥18 years old) were 55.7/100,000 (95%CI 42.7–72.6/100,000) and 124.5/100,000 (95%CI 113.9–136.1/100,000), respectively. The prevalence of inherited neuropathies, myopathies and spinal muscular atrophies were 38.6/100,000 (95%CI 33.5–44.2/100,000), 66.6/100,000 (95%CI 59.7–74.3/100,000) and 3.7/100,000 (95%CI 2.3–5.8/100,000), respectively.

Disease specific point prevalence was among others Charcot-Marie-Tooth 30.0/100,000 (95%CI 25.5–35.3/100,000), hereditary neuropathy with liability to pressure palsies 8.0/100,000 (95%CI 5.9–11.0/100,000), myotonia congenita 11.7/100,000 (95%CI 9.0–15.2/100,000), myotonic dystrophy type I 13.4/100,000 (95%CI 10.5–17.0/100,000), myotonic dystrophy type 2 6.4/100,000 (95%CI 4.5–9.0/100,000), Duchenne muscular dystrophy 7.3/100,000 (95%CI 4.6–11.5/100,000), Becker muscular dystrophy 1.6/100,000 (95%CI 0.6–4.1/100,000), facio-scapulohumeral muscular dystrophy 3.7/100,000 (95%CI 2.3–5.8/100,000), and limb-girdle muscular dystrophy 12.7/100,000 (95%CI 9.9–16.3/100,000).

Conclusion: The prevalence of inherited neuromuscular disorders in Northern Norway is higher than previously suggested in European studies. The prevalence was especially high for myotonia congenita and limb-girdle muscular dystrophy, but Charcot-Marie-Tooth neuropathy was lower than previously reported in the Norwegian population.

Disclosure: Nothing to disclose

EPR2156

Long-term follow-up in presymptomatic LOPD patients

O. Musumeci¹, G. Tavilla², R. Oteri¹, A. Ciranni³, A. Pugliese³, A. Toscano⁴

¹University of Messina, Messina, Italy, ²UOC Neurologia e Malattie Neuromuscolari, AOU Policlinico “G. Martino”, Messina, Italy, ³University of Messina, MESSINA, Italy, ⁴Messina, Italy

Background and aims: Late-onset Pompe disease (LOPD) is characterized by a wide spectrum of clinical presentations ranging from classical forms with manifested muscle weakness and/or respiratory impairment to isolated hyperckemia. A better awareness of the disease and the diffusion of newborn screening programs increased number of patients diagnosed at presymptomatic stage. The identification of these patients raises the consideration how to follow these patients in the view of early detection of disease progression to start therapy.

Methods: Herein we report on 8 patients with presymptomatic Pompe disease followed at our Neuromuscular Unit since the diagnosis was made. Patients were followed every 6-12 months with clinical examination including functional tests, pulmonary function tests and muscle MRI

Results: The patients had a mean age of 29 (range 4-58) years, a median follow-up duration of 10 (range 4-15) years. All patients were diagnosis because of isolated hyperckemia (CK range 400 to 1100IU) and/or myalgia. Muscle biopsy revealed a vacuolar myopathy with glycogen storage in 4 pts whereas was unspecific in 3pts, not performed in 1. Muscle GAA residual activity range from 3.8% to 15%. 2 patients, after respectively 9 and 6 yrs of follow-up, start ERT because of detection of signs of muscle weakness and respiratory impairment. 6pts were stable over the years with only persistent mild hyperckemia but no other signs of progression.

Conclusion: Our data demonstrated that presymptomatic LOPD patients may remain clinically silent for decades but they should be monitored closely for overt signs of the disease to promptly start ERT

Disclosure: Nothing to disclose

EPR2157

Motor Function Change Over Time Among Nusinersen-Treated Participants with Infantile-onset Spinal Muscular Atrophy (SMA) in the ENDEAR-SHINE Study Who Met the Permanent Ventilation (PV) Definition

D. Castro¹, J. Wong², B. Kandinov², R. Foster³,
A. Paradis², N. Johnson²

¹Department of Pediatrics, University of Texas Southwestern Medical Center, Dallas, USA, ²Biogen, Cambridge, MA, USA, ³Biogen, Maidenhead, Berkshire, United Kingdom

Background and aims: Participants with infantile-onset SMA who completed the Phase 3 ENDEAR study (NCT02193074) were eligible to receive nusinersen in the open-label extension study, SHINE (NCT02594124).

Methods: At final analysis of the ENDEAR study, 68% of control and 39% of nusinersen-treated participants had died or received PV (defined as tracheostomy or ≥ 16 hours/day of ventilatory support continuously for >21 days in the absence of an acute reversible event). Participants requiring PV in ENDEAR could continue into SHINE. Post hoc analyses (15 October 2018 SHINE data cut) evaluated motor function change for nusinersen-treated participants in ENDEAR, who continued into SHINE and reached PV in either study.

Results: The median (min, max) time from 1st nusinersen dose to date of PV (in ENDEAR or SHINE) was 90.5 (38, 525) days (n=24). For participants on nusinersen, median (min, max) time was 207 (23, 387) days from date of PV to last assessment in ENDEAR (n=18) and 922 (272, 1300) days to last assessment in SHINE (n=24). The majority of participants who reached PV in ENDEAR-SHINE (n=24) demonstrated improvements in total HINE-2 and CHOP INTEND scores over time following PV. Among participants with ≥ 2 evaluable efficacy assessments following PV (n=21), mean improvements (SD) in HINE-2 and CHOP INTEND scores from 1st available assessment following PV to last study visit were 3.0 (3.4) and 4.1 (7.6), respectively; range of time between assessments was 126–1234 days.

Conclusion: Participants treated with nusinersen who reached PV during ENDEAR-SHINE continued to demonstrate clinical benefit assessed via motor function change over time.

Disclosure: This study was sponsored by Biogen (Cambridge, MA, USA). Writing and editorial support for the preparation of this abstract was provided by Excel Scientific Solutions (Horsham, UK): funding was provided by Biogen.

EPR2158

Efficacy and safety of non-steroidal immunosuppressive treatments in Generalized Myasthenia Gravis patients. A systematic review and meta-analysis

S. Pastor¹, M. García², M. Sastre¹, E. De Celis Ruiz¹,
M. Fernandez-Fournier¹, F.J. Rodríguez de Rivera¹,
E. Díez-Tejedor³

¹Madrid, Spain, ²Autonoma University of Madrid, Madrid, Spain, ³Neurology department and Stroke centerdepartment and Stroke center, Hospital Universitario la Paz, Madrid, Spain

Background and aims: Myasthenia Gravis (MG) treatment consists of the use of acetylcholinesterase inhibitors, corticosteroids and, in cases of insufficient response, immunosuppressive treatments. Our aim is to evaluate the efficacy and safety of immunosuppressive drugs in generalized MG through a systematic review and meta-analysis.

Methods: We performed a systematic review (PUBMED, EMBASE and Clinical trials gov, 2 January to 1 February 2019) to identify all the randomized clinical trials and cohort studies evaluating the effects of adding immunosuppressive drugs to the treatment of patients with generalized MG. Data analysis was performed using Review Manager 5 software and results were summarized as odds ratio (OR), mean difference and 95% confidence intervals (CI). We evaluated: (1) change in the Quantitative Myasthenia Gravis (QMG) score at the end of the study from baseline and (2) number of dropouts due to adverse events (AE).

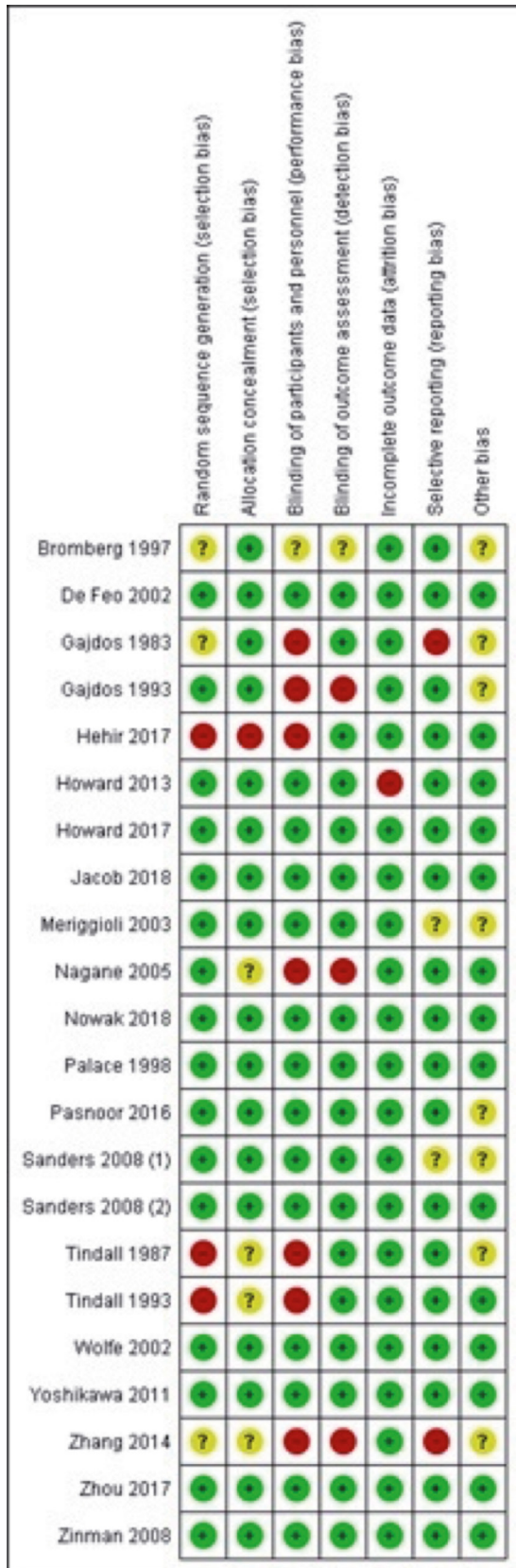

Risk of bias summary

Results: A total of 323 manuscript were retrieved in the systematic review. We selected 22 articles. Treatment with tacrolimus, cyclosporine, cyclophosphamide, rituximab and eculizumab showed significant effects on the QMG score. There were more dropouts in the experimental groups compared to placebo, with statistically significant differences (OR 1.74, 95%CI 1.03-2.95).

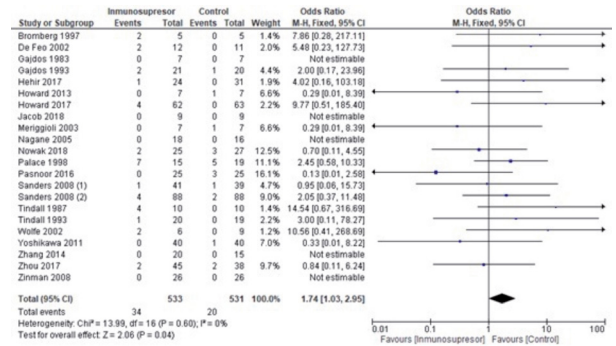

Forest plot of meta-analysis of EA in all the studies, odds ratios, overall odds ratios and 95% CI related to each categorical outcome measure

Conclusion: Tacrolimus, rituximab and eculizumab stand out as the treatments with better efficacy and safety profile in generalized MG resistant to 1st-line treatments, although more studies with greater homogeneity are needed to draw conclusions that lead to algorithms of therapeutic decision.

Disclosure: Nothing to disclose

Neuroepidemiology; Neurotoxicology; Neurotraumatology

EPR2159

Laugh is in the air: a case series of neurological problems due to recreational use of laughing gas.

A. Bruijnes¹, R. Lamberts², D. Pröpper¹

¹Neurology, Zuyderland Medisch Centrum, Heerlen, Netherlands, ²Neurology, Maastricht University Medical Centre, Maastricht, Netherlands

Background and aims: In recent years recreational use of laughing gas (nitrous oxide) has grown more popular. Well known adverse effects include polyneuropathy or subacute spinal cord degeneration due to vitamin B12 deficiency. Therefore, the number of patients presenting with these types of neurological problems is increasing.

Methods: Case series describing clinical features and ancillary investigations of patients using laughing gas, presenting at our outpatient clinic and emergency department during 2017-2019.

Results: We found 12 patients with a median age of 21 years, of which eight presented in 2019. Common complaints were paresthesias and lower limb weakness. 7 patients were diagnosed with axonal polyneuropathy using EMG. In 4 patients MR imaging showed T2-hyperintensities of the cervical dorsal columns, indicating subacute spinal cord degeneration. There was no correlation between clinical presentation and the cumulative amount of laughing gas used. All patients received vitamin B12 suppletion and were advised to stop using laughing gas. Whereas most patients fully recovered, some retained minor symptoms. 2 patients experienced problems in activities of daily living and were referred to a rehabilitation physician.

Conclusion: Due to increased recreational use of laughing gas more patients with neurological complaints have been presenting at our hospital, especially those of younger age. This is probably an underestimation, assuming patients with minor complaints might not seek medical help. With vitamin B12 suppletion and complete cessation of laughing gas use, symptoms may fully disappear. In some cases however, complaints may persist.

Disclosure: Nothing to disclose

EPR2160

Myelopathy after nitrous oxide inhalation

V.-G. Elena, C. Hobeau, O. Sahloul, A. Martin-Bechet, P. Amarenco, P. Lavallée

Neurology, Bichat Claude Bernard, Paris, France

Background and aims: Nitrous oxide (N₂O) is a common medical inhalational anaesthetic but it's also widely used for recreational activities. N₂O irreversibly alters B12 activation, causing posterior myelopathy and sensorimotor polyneuropathy.

Methods: Case report

Results: Case 1

A 30-year-old man, vegetarian, was admitted with paresthesia, progressive motor deficit of the 4 limbs, inability to walk, bladder impairment and fecal incontinence within 6 days after using N₂O for 4 hours. Clinical examination showed a sensory deficit up to T3-T4 level, proprioceptive loss, tetraparesis with distal predominance, anal sphincter hypotonia, Lhermitte's sign. MRI of the spinal cord showed abnormal T2-weighted hyperintensity in the posterior area at C3-C5 levels, without contrast enhancement. B12 was 131pmol/dl. CSF was normal and all infectious and autoimmune investigations were negative. Urines were positive for benzodiazepine. He was treated with high doses of B12 and corticosteroids showing clinical improvement but had permanent sequelae at 12 months.

Case 2

A 28-year-old man started using nitrous oxide, 3-4 capsules/day for 4 days (cannabis withdrawal context). He complained of distal paresthesias of upper limbs, Lhermitte's sign and anxiety. Clinical examination was normal. MRI of the spinal cord showed hyperintensity in T2 in the posterior area of C5-C7. Other tests (including CSF, B12 and homocysteine) were normal. High doses of B12 vitamines rapidly improved the sensory symptoms.

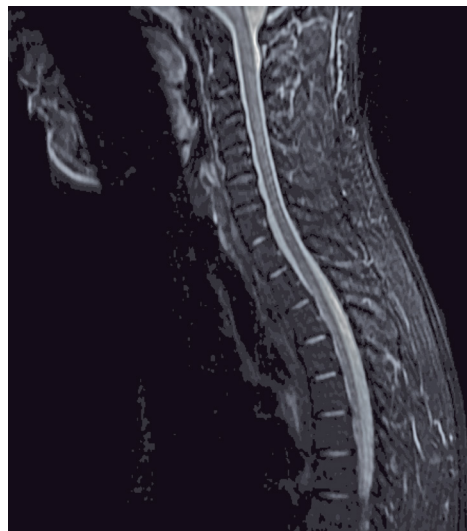

Cervical MRI case 1: abnormal T2 weighted hyperintensity in the posterior aspect of C3-C5

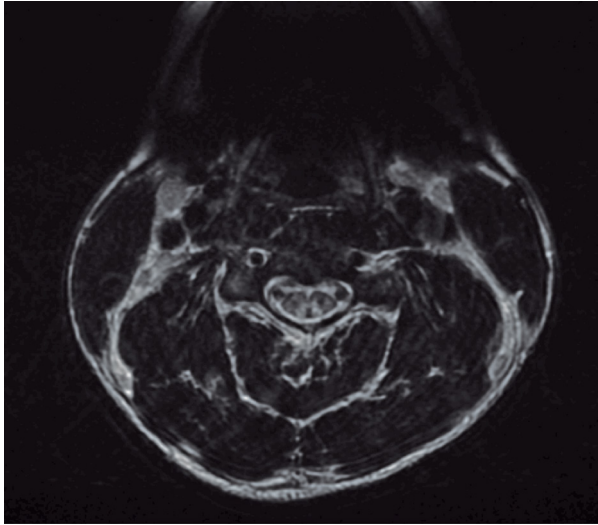

Cervical axial MRI case 1 abnormal T2 hyperintensity in the posterior columns

Conclusion: We present 2 cases of myelopathy after nitrous oxide inhalation that illustrate the clinical variability and the risks related to its consumption.

Disclosure: Nothing to disclose

EPR2161

Short-term outcomes of immediate post-traumatic seizures after lateral fluid percussion brain injury in rats

S.O. Frankevich, I. Komoltsev, N. Gulyaeva, M. Novikova

Dept. of Functional Biochemistry of the Nervous System, Institute of Higher Nervous Activity and Neurophysiology, RAS, Moscow, Russian Federation

Background and aims: Immediate and early seizures are important pathophysiological consequence of tissue damage in traumatic brain injury (TBI). They also represent a significant risk factor for post-traumatic epilepsy (PTE) development. A thorough analysis of acute seizures and their consequences are complicated in clinical studies. Our study aimed to analyze immediate post-traumatic seizures, hemodynamic, breathing and reflexes disturbances after TBI in rats.

Methods: The study was performed on 60 male Wistar rats aged 6 months. Craniotomy localized above right sensorimotor cortical area was performed under isoflurane anesthesia. After complete awakening from anesthesia, TBI was modelled using lateral fluid percussion. During the impact itself and following 5 min, video-recording was carried out. The recordings were analyzed for jumps, running, walking movement, tonic and clonic components of the seizure, tail seizures, apnea periods, ataxic breathing, loss of righting reflex and pain sensation.

Results: Immediate post-traumatic seizures were observed in 100% of animals and were highly heterogeneous, similarly to human ones. Strong correlations between duration of seizure and loss of righting reflex, pain sensation and posture recovery were found. Hemodynamic changes contributed to longer recovery time after seizure. Prolonged immediate seizures, ataxic breathing, loss of reflexes were associated with acute mortality.

Conclusion: We analyzed for the 1st time detailed semiology of immediate post-traumatic seizures in rats. The duration of immediate seizures correlates with loss of reflexes and predicts mortality. The results confirm an importance of acute seizures in the pathogenesis of TBI.

Disclosure: Supported by RFBR, grant №19-015-00258

EPR2162

Association of social relationships with incident cardiovascular events and all-cause mortality

J. Gronewold¹, R. Kropp², N. Lehmann³, B. Schmidt⁴, S. Weyers⁵, J. Siegrist⁵, N. Dragano⁵, K.-H. Jöckel³, R. Erbel⁶, D.M. Hermann¹

¹Essen, Germany, ²Neurology, University Hospital Essen, Essen, Germany, ³Institute of Medical Informatics, Biometry and Epidemiology, University of Duisburg-Essen, Essen, Germany, ⁴University of Duisburg-Essen, Institute of Medical Informatics, Biometry and Epidemiology, Essen, Germany, ⁵Heinrich-Heine-University Düsseldorf, Institute of Medical Sociology, Medical Faculty, Düsseldorf, Germany, ⁶Cardiology, University Hospital Essen, Essen, Germany

Background and aims: To examine how different aspects of social relationships are associated with incident cardiovascular events and all-cause mortality.

Methods: In 4139 participants from the population-based Heinz Nixdorf Recall study without previous cardiovascular disease (mean (standard deviation) age 59.1 (7.7) years, 46.7% men), the association of self-reported instrumental, emotional, and financial support and social integration at baseline with incident fatal and non-fatal cardiovascular events and all-cause mortality during 13.4-year-follow-up was assessed in 5 different multivariable Cox proportional hazards regression models: minimally adjusted model (adjusting for age, sex, social integration or social support, respectively); biological model (minimally adjusted + systolic blood pressure, low-density and high-density lipoprotein cholesterol, glycated hemoglobin, body-mass-index, antihypertensive-, lipid-lowering-, and antidiabetic medication); health behavior model (minimally adjusted + alcohol consumption, smoking, physical activity); socio-economic model (minimally adjusted + income, education, employment); depression model (minimally adjusted + depression, antidepressants, anxiolytics).

Results: 339 cardiovascular events and 530 deaths occurred during follow-up. Lack of financial support was associated with an increased cardiovascular event risk (minimally adjusted hazards ratio=1.30 (95% confidence interval= 1.01-1.67)). Lack of social integration (social isolation) was associated with increased mortality (minimally adjusted hazards ratio=1.47 (1.09-1.97)). Effect estimates did not decrease to a relevant extent in any regression model.

Conclusion: Perceiving a lack of financial support is associated with a higher cardiovascular event incidence and being socially isolated is associated with increased all-cause mortality. Future studies should investigate how persons with deficient social relationships could benefit from targeted interventions.

Disclosure: Nothing to disclose

EPR2163

Hereditary peripheral neuropathies in Bulgaria: genetic and ethnic features

K. Kastreva¹, T. Chamova¹, V. Gergelcheva², S. Cherninkova¹, B. Ishpekova³, A. Jordanova⁴, I. Tournev⁵

¹Department of Neurology, Medical University, University Hospital Alexandrovska, Sofia, Bulgaria, ²Department of Neurology, University hospital SofiaMed, Sofia, Bulgaria, ³University Hospital "Tsaritsa Ioanna-ISUL", Sofia, Bulgaria, ⁴Molecular Neurogenomics Group, VIB-UAntwerp Center for Molecular Neurology, University of Antwerp, Antwerp, Belgium, ⁵Sofia Medical University, Department of Neurology, University Hospital Alexandrovska, Department of Cognitive Science and Psychology, New Bulgarian University, Sofia, Bulgaria

Background and aims: Hereditary peripheral neuropathies (HPN) are a heterogeneous group of diseases caused by mutations in more than 80 genes. They are the most common hereditary neurological disease, though their prevalence varies among the different populations. The purpose is to determine the genetic variety between the main ethnic groups in Bulgaria (Bulgarian, Roma and Turk), their distribution in the different administrative districts in the country.

Methods: 3 sources of data were used: 1. patients that were referred to the Expert Centre for Hereditary Neurologic and Metabolic Disorders, 2. field studies and screening programs in more than 2500 towns and villages in the country, 3. National Genetic Laboratory database.

Results: In total 835 patients with genetically confirmed mutations were included. In 542 Bulgarians, living in 25 districts, were found mutations in 12 different genes (PMP22, YARS, MPZ, GJB1, GARS, MFN2, HINT1, HSP22, SH3TC2, NDRG1, GDAP1, BSCL2). In the Roma population (n=262), inhabiting 22 districts, were determined genetic defects in 7 different genes (NDRG1, CTDP1, HK1, HINT1, GJB1, PMP22, MPZ). In 31 Turks, living in 7 districts, were confirmed genetic defects in 5 genes (GJB1, PMP22, MPZ, BSCL2, HINT1). The mutations were inherited in different traits: autosomal dominant HPN were observed in 86.3% of the Bulgarians, autosomal recessive HPN - in 95.4% of Roma patients, and X-linked mutations - in 48.4% of the Turks.

Conclusion: Genetic heterogeneity was found among the population in Bulgaria, as well as all inheritance patterns (autosomal-dominant, autosomal-recessive and X-linked). Specific ethnic distribution of the mutations and inheritance manners were determined.

Disclosure: Nothing to disclose

EPR2164

Electrographic changes and mortality in early period of traumatic brain injury: From humans to animal model

I. Komoltsev¹, M. Novikova¹, A. Volkova¹, O. Kordonskaya², A. Talygov², M. Sinkin², N. Gulyaeva¹
¹Dept. of Functional Biochemistry of the Nervous System, Institute of Higher Nervous Activity and Neurophysiology, RAS, Moscow, Russian Federation, ²Sklifosovsky research institute of Emergency medicine, Moscow, Russian Federation

Background and aims: Nonconvulsive electrographic seizures (ES) and epileptiform activity (EA) in early period of TBI often remain undiagnosed. The aim of the study was (1) to reveal occurrence and short-term outcomes of ES and EA in patients with acute TBI on invasive ECoG recordings and compare its sensitivity with scalp EEG recordings; (2) to determine possible neural substrate of early post-traumatic EA using a TBI model in rats.

Methods: ECoG (mean 37h) were recorded in 11 patients with acute TBI subjected to surgical treatment with a decompressive craniotomy. Abnormalities were obtained in scalp EEG and invasive ECoG recordings. TBI in 36 adult male Sprague-Dawley rats was modeled using lateral fluid percussion. ECoG and local field potentials were recorded in animals during 7 days before and after TBI to reveal early electrographic abnormalities and an involvement of cortico-hippocampal and cortico-thalamic networks.

Results: EA was recorded in 18% of patients using scalp EEG and in 45% using EEG with ECoG; rhythmic periodic patterns were recorded in 64 vs.91% of patients; ES was recorded in 45% vs.55% of patients. Levels of consciousness predicted mortality during hospitalization.

ECoG abnormalities in almost all rats were independently registered in the cortex (spike-wave discharges) and hippocampus (spikes). The duration of loss of reflexes after TBI predicted acute mortality.

Conclusion: Using ECoG in patients subjected to surgical treatment after TBI increase detectability of acute electrographic abnormalities. In rats they involve cortical and hippocampal networks independently. Loss of consciousness predicts mortality both in patients and in experimental animals.

Disclosure: Supported by RFBR, grant №19-015-00258

EPR2165

Premature mortality and causes of death of people with epilepsy in South Korea

H. Moon¹, S.-Y. Lee²

¹Department of Neurology, Soonchunhyang University Bucheon Hospital, Bucheon, Korea, Republic of,

²Department of Neurology, School of Medicine, Kangwon National University, Chuncheon, Korea, Republic of

Background and aims: Previous studies have consistently reported premature mortality of people with epilepsy. However, there is no epidemiological study about mortality of people with epilepsy in South Korea.

Methods: Using the National Health Insurance Service database and National Death Registry of Korea, a retrospective cohort study of people with epilepsy was carried out. Epilepsy patients was defined as a current medication history of antiepileptic drugs AND the presence of International Classification of Disease (ICD)-10 codes of G40* (epilepsy), G41* (status epilepticus), F803 (Landau-Kleffner syndrome), and R56 (convulsion). Incident case was defined as epilepsy patients with 2-year disease free period. Specific causes of death were recorded according to ICD-10 codes.

Results: Using incident patient cohort from 2009 to 2017, 20,213 deaths (among total 138,998 incident patients) were recorded. Overall mortality (standardized mortality ratio, SMR) in incident people with epilepsy was 2.36 (95% CI, 2.33-2.40). The SMRs attenuated with increasing age and disease duration. The SMRs were associated with residence, household income, disease burden, history of status epilepticus, and comorbid disease. The common causes of death were cancer (N=4,503, proportional mortality ratio, PMR: 22.4%), Sequelae of cerebral vascular disease (N=2,044, 10.2%), External causes (N=1,441, 7.2%), and Pneumonia (N=1,198, 6.0%). Among external causes, suicide was the most common cause of death (N=525, 2.6%).

Conclusion: In South Korea, people with epilepsy have a higher risk of premature death. Although symptomatic causes of epilepsy were the most common causes of death, there are many preventable deaths such as suicide.

Disclosure: Nothing to disclose

EPR2166

Prognostic assessment of combined NSE and S100 biomarkers on cognitive outcome after Traumatic Brain InjuryD.F. Muresanu¹, D. Slavoaca², S. Strilciuc²*¹Neurosciences, "Iuliu Hatieganu" University of Medicine and Pharmacy, Cluj, Romania, ²Neurosciences, "RoNeuro" Institute for Neurological Research and Diagnostic, Cluj-Napoca, Romania*

Background and aims: Traumatic Brain Injury (TBI) is considered a possible risk factor for development of late-life dementia. The link between TBI and dementia development is inconclusive throughout the literature. We explored the association between TBI and dementia development cascade, specifically to investigate whether biomarkers Neuron-Specific Enolase (NSE) and S100 calcium-binding protein B associated are predictors for cognitive outcome after TBI.

Methods: We performed 2ndary data analysis on TBI patients from a single-center clinical trial. NSE and S100 were determined at 48 and 72 hours after admission and neurocognitive outcomes were measured at study days 10, 30 and 90. Pooled ensembles were included in multivariate linear regression models to determine the predictive value of NSE, S100 and their combination on a multidimensional ensemble of TBI outcome scales, controlling for severity of the injury, age, and gender.

Results: A total of 142 patients aged 19-79 with a diagnosis of TBI were included in multivariate linear regression models. A strong prediction value of NSE and S100 at 24h was observed for Hospital Anxiety Depression Scale (30, 90 days), Stroop Color-Word Test, Digit Span (30, 90 days) and Processing Speed Index (10, 30, 90 days) and the combined outcome ensemble.

Conclusion: Using several indicators in conjunction to create a composite biomarker for TBI outcome appears to be a more robust approach for prediction of cognitive outcome.

Disclosure: Nothing to disclose

EPR2167

Post-traumatic Transient Neurologic Dysfunction: A Proposal for PathophysiologyC. Oh¹, S.-Y. Lee², S.J. Lee², J.H. Phi³*¹Department of Neurology, Kangwon National University Hospital, Chuncheon, Korea, Republic of, ²Department of Neurology, Kangwon National University School of Medicine, Chuncheon, Korea, Republic of, ³Division of Pediatric Neurosurgery, Seoul National University College of Medicine, Seoul, Korea, Republic of*

Background and aims: Sudden neurological deterioration which cannot be explained by structural change, ischemia or seizure is often observed among patients with traumatic brain injuries. We aimed to provide new insight into the pathophysiology of posttraumatic transient neurologic dysfunction.

Methods: We describe prolonged but fully reversible focal neurologic dysfunction of unknown origin based on the initial evaluation in 16 patients with traumatic brain injury. We performed brain imaging, including diffusion weighted imaging and computed tomography, and electroencephalography (EEG) during the episodes.

Results: The symptoms consisted of dysarthria, hemiparesis, hemiparesthesia of limbs contralateral to the affected side, or aphasia. These symptoms developed between 12 hours and 15 days after trauma and lasted between 12 hours and 16 days. Structural imaging did not show any significant interval change compared with the immediate posttraumatic images. Perfusion imaging showed increased cerebral blood flow in the symptomatic hemisphere. EEG revealed low amplitude arrhythmic slowing in the corresponding hemisphere.

Conclusion: Transient neurologic dysfunction can occur during the acute phase of traumatic brain injury. Although this may last more than usual transient ischemic attack or seizure, it eventually resolves regardless of treatment. Based on our observation, we propose that this is the manifestation of the transient cortical spreading depression occurring injured brain, analogous to migraine aura.

Disclosure: Nothing to disclose

EPR2168

Decision tree machine learning to predict unfavorable outcome in surgically treated patients with chronic subdural hematomas

L. Riemann, K. Zweckberger, C. Habel, J. Fischer, A. Unterberg, A. Younsi
Neurosurgery, Heidelberg University Hospital, Heidelberg, Germany

Background and aims: The incidence of chronic subdural hematomas (cSDH) is expected to double in the next 20 years. Although often perceived as a “benign” condition, considerable rates of mortality and poor outcome have been reported. We therefore evaluated factors associated with an unfavorable outcome after surgical treatment of cSDH patients using machine-learning.

Methods: Patients treated for cSDH with surgical evacuation between 2006-2018 at a single institution were retrospectively analyzed. Potential demographical, clinical, imaging and laboratory predictors were assessed and a decision-tree predicting unfavorable outcome (GOS 1-3) was developed using the Classification and Regression Tree (CART) algorithm. Out-of-sample model performance was evaluated using repeated cross-validation.

Results: 755 eligible patients were analyzed. Median age was 75 (IQR 68-81) years and 69% were males. Mortality rate was 1.6% and rate of unfavorable outcome was 14.3%. The developed decision-tree to predict unfavorable outcome had 5 splits and included the following 4 clinical variables (in descending order of calculated importance): GCS, comorbidities, Hb, and age. After cross-validation, the following model performance metrics were obtained: a model accuracy of 0.88 (0.85-0.90), sensitivity of 0.35 (0.19-0.51), and specificity of 0.96 (0.94-0.99).

Conclusion: GCS, comorbidities, Hb, and age were identified as the most important clinical predictors for an unfavorable outcome in cSDH patients after surgery. The developed model was simple and still displayed a high accuracy and very high specificity, the sensitivity was however rather low. Our results might help clinicians to better assess the prognosis in patients with cSDH.

Disclosure: Nothing to disclose

EPR2169

Epidemiological trends of medicated adult parkinsonism in Finland

J. Sipilä¹, V. Kaasinen²

¹Joensuu, Finland, ²Division of Clinical Neurosciences, University of Turku and Turku University Hospital, Turku, Finland

Background and aims: Parkinson’s disease is becoming more common as populations age, but more data are needed to refine the prediction models. We investigated epidemiological trends of medicated parkinsonism in Finland.

Methods: The annual numbers of new and prevalent reimbursement rights parkinsonism drugs for persons >30 years of age were obtained from the national authority for years 2001-2018. Standardisation was performed using the direct method and the European Standard Population 2013.

Results: Overall crude incidence was 46.7/100,000 (95% CI 46.2-47.3) person-years and it increased from 40.0 (95% CI 37.9-42.2) in 2001 to 48.5 (95% CI 46.3-50.8) in 2018 ($p<0.0001$). Incidence increased both in men ($p<0.0001$) and women ($p=0.016$) during the study period. However, age-standardized annual incidence fluctuated between 42.9 and 53.1 per 100,000 person-years with no trend ($p=0.32$). Crude prevalence increased from 418.9 (95% CI 412.0-426.0) in 2001 to 486.9 (95% CI 479.8-494.1) in 2018 ($p<0.0001$) but age-standardized prevalence decreased from 488.2/100,000 in 2001 to 446.6/100,000 in 2018 ($R=0.89$, $p<0.00001$; figure).

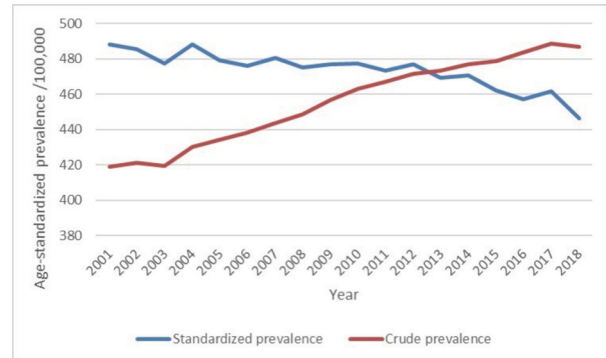

Figure. The annual crude and age-standardized (European Standard Population 2013) prevalence of medicated parkinsonism in people >30 years of age in Finland

Conclusion: Medicated parkinsonism has become more frequent in Finland during the last two decades. However, its age-adjusted prevalence has decreased concurrently.

Disclosure: Jussi Sipilä has received honoraria (Merck, Pfizer, Sanofi), has received a consultancy fee (Rinnekoiti Foundation), has received travel grants and congress sponsorship (Abbvie, Orion Pharma, Merck Serono, Sanquin, Lundbeck, Novartis) and holds shares (Orion Corporation). Valtteri Kaasinen serves as an advisory board member of Abbvie and has received speaker’s honoraria from Orion Pharma, Teva, GE Healthcare, Abbvie and NordicInfu Care AB; travel expenses from NordicInfu Care AB; and research funding from the Finnish Alcohol

Research Foundation, the Päivikki and Sakari Sohlberg Foundation, the International Parkinson and Movement Disorder Society, and Finnish governmental research funding (ERVA).

EPR2170

Predict and Prevent Chronic Traumatic Encephalopathy: Early detection of subtle neuronal dysfunction after Mild CT/MRI Negative Traumatic Brain Injury using Brainstem Auditory Evoked Potentials

D. Tsakova¹, D. Kolev², G. Popov³, D. Dimov⁴, L.D. Traykov⁵

¹Consulting & Diagnostic Department, Military medical academy, Sofia, Bulgaria, ²Clinic of neurology, Military medical academy, Sofia, Bulgaria, ³Department of Infectious Diseases, Military Medical Academy, Sofia, Bulgaria, ⁴Department of Disaster Medicine, Military Medical Academy, Sofia, Bulgaria, ⁵Clinic of neurology, Medical University - Sofia, Sofia, Bulgaria

Background and aims: Traumatic brain injuries (TBI) are public health problem of great importance. The conventional imagings CT/MRI are limited in their capacity to assess microstructural or functional damages due to mild TBI (mTBI). There is an increasing urgency to develop new diagnostic modalities for the accurate identification of at-risk patients. The aim of this study is to investigate changes of Brainstem Auditory Evoked Potentials (BAEP) as diagnostic and prognostic neurophysiological markers in mild TBI.

Methods: 75 patients with concussion were included in the study. 1st group (54 patients): BAEPs were conducted in the first month after injury. BAEP follow-up was carried out on the 3rd, 6th month to 16 of them. The 2nd group (21 patients) was not tested immediately after concussion, but on the 3rd, 6th month, 1 year after the trauma (despite the normal results from CT/MRI, complaints of the patients persist and disturb their quality of life).

Results: In the 1st month after the trauma 28 patients had delayed peak latencies, abnormal prolongation of interpeak intervals, interaural differences, low amplitude or absence of main waves. More than one type of abnormalities were found in 17 cases. The abnormalities persist in subsequent BAEP for 25 patients (fig1).

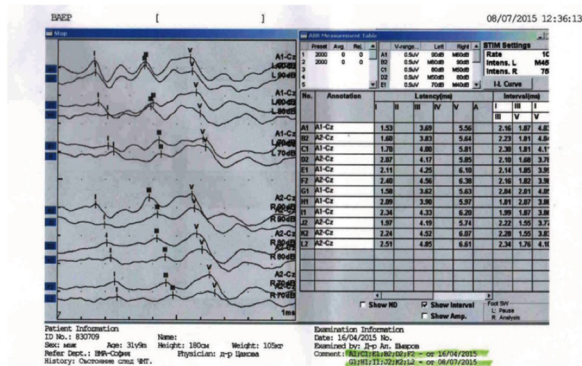

Fig.1. Abnormal BAEP on the 7th day and in 3rd month after the MTBI: delayed peak latency of the main waves I, III, V, abnormal prolongation of interpeak intervals. Some waveforms contain both abnormalities.

Conclusion: BAEP can be applied as a diagnostic method in patients with concussion. Conducting control BAEP has an important role in monitoring the dynamics of pathological process. Persistent BAEP-abnormalities can be used as diagnostic and prognostic neurophysiological markers for the accurate identification of at-risk patients and the initiation of preventative therapy early in the disease course.

Disclosure: Nothing to disclose

Neurogenetics 1

EPR2171

Exome sequencing identifies CHCHD2 variant in a patient with early onset multiple system atrophy and coexisting mitochondrial pathology in muscle

P. Balicza, Z. Grosz, A. Palasti, V. Molnar, M.J. Molnar
*Institute of Genomic Medicine and Rare Diseases,
 Semmelweis University, Budapest, Hungary*

Background and aims: CHCHD2 associated Parkinsonism is a recently described form of autosomal dominant Parkinson's disease (PARK22), however there is some ambiguity about the exact role of the gene. CHCHD2 variants were mainly reported in late-onset PD cases, but also in 1 patient with late onset multiple system atrophy (MSA), and patients with different forms of dementia. In animal models and human derived fibroblast culture mitochondrial pathology was captured.

Methods: We report a case with an early onset MSA-like phenotype. Brain MRI, electrophysiologic, myopathological studies, and whole exome sequencing was performed for diagnostic purposes.

Results: The patient's symptoms started at age 38 years with progressive orthostatic hypotension. 4 years later proximal muscle weakness and general fatigue developed. Rapidly deteriorating Parkinsonism appeared in the next years, with additional pyramidal signs. Electrophysiologic studies detected mild spontaneous activity plus myogenic lesion, and mild demyelinating neuropathy. Muscle biopsy showed mitochondrial dysfunction with ragged blue and COX negative fibers. EM revealed abnormal, pleioclonal mitochondria. Hot spot mutations of the mitochondrial genome were excluded. The MRI detected cerebellar atrophy. The exome sequencing identified a heterozygous damaging variant in the CHCHD2 gene absent from in-house and population databases. Additional variants of uncertain significance were present in the SETX and SPG11 genes.

Conclusion: This case report expands the phenotypic spectrum of CHCHD2 associated Parkinsonism, with an early onset MSA-like phenotype characterized by severe orthostasis, and additional mild neuromuscular abnormalities. The muscle biopsy, which was not previously available from patients with CHCHD2 variants, provides an in vivo evidence for mitochondrial dysfunction.

Disclosure: The authors of this publication are members of the European Reference Network for Rare Neurological Diseases - Project ID No 739510.

EPR2172

Asymptomatic Adrenoleukodystrophy in Elderly Males

C. Benzoni, S. Fenu, V. Pensato, D. Pareyson, E. Salsano
Istituto Neurologico C. Besta, Milan, Italy

Background and aims: Adrenoleukodystrophy (ALD) is an X-linked disease caused by ABCD1 mutations and characterized by wide phenotypic spectrum. Virtually all male patients with ALD who reach adulthood develop a varying degree of disease-related symptoms, with typical onset in the 3rd or 4th decade, and compatible with myelopathy.

Methods: We reviewed the clinical and laboratory information of our cohort of 53 adult ALD patients followed in our Institute from Jan 2004 to Dec 2019.

Results: We identified 2 ALD male patients (4%) who were still asymptomatic in the 7th decade. They both were investigated for ABCD1 mutations because relatives of symptomatic patients, but their neurological examination, brain MRI and adrenal function were normal. The 1st patient was a 62-year-old man with the R389C ABCD1 mutation, who developed erectile dysfunction at the age of 70. The 2nd one was a 64-year-old man with the W339G ABCD1 mutation, 1st seen at the age of 56.

Conclusion: Our observation suggests that ALD males may not develop any symptom or sign even late in life, and lends support to previously published case series where exceptional, asymptomatic elderly ALD males are mentioned, but not well documented. It is impossible to predict when these individuals will develop the disease, if ever. However, their existence should be kept in mind for genetic counseling, and may be in agreement with recent results from newborn screening showing ALD is more common than previously described. Finally, these individuals may represent a rare but unique opportunity for the identification of ALD protective factors.

Disclosure: Nothing to disclose

EPR2173

MCI and AD: a predictive model for risk assessment and disease progression

R. Cascella¹, A. Termine¹, V. Caputo², C. Strafella², G. Spalletta¹, E. Giardina¹

¹Santa Lucia Foundation, Rome, Italy, ²Tor Vergata University, Rome, Italy

Background and aims: Cognitive decline is normally associated with aging, although it can sometimes be suggestive of pathological neurodegeneration, Mild Cognitive Impairment (MCI) and ultimately, Alzheimer Disease (AD). This study aimed to identify a set of predictive biomarkers specific for MCI and AD.

Methods: 436 patients (245 MCI and 191 AD) were recruited at the IRCCS Santa Lucia. Genomic DNA was subjected to genotyping analysis by Open Array platform, which consisted of 120 Single Nucleotide Polymorphisms (SNPs). The results were processed by statistical (Information Theory and Logistic Regression) and bioinformatic (GSEA, IPA, String, Phenolyzer) tools for assessing the significant association with the diseases and selecting the SNPs to be tested as predictive/prognostic biomarkers for MCI and AD.

Results: Statistical results identified 11 SNPs and 12 SNPs as candidate predictors for MCI and AD, respectively. The logistic regression performed on these data revealed that 2 SNPs were significantly associated with MCI (Table 1) and 4 SNPs with AD (Table 2). Given these results, 2 accurate models were developed for classifying MCI/AD cases and control subjects (Table 3). Bioinformatic analysis indicated that the associated SNPs participate in several biological pathways implicated in the etiopathogenesis and progression of MCI and AD.

Gene	Informative SNP	p-value	Biological pathways
VSIG4	rs1044165	0.01	<ul style="list-style-type: none"> cell survival adhesion/cellular localization Neuroinflammation Angiogenesis Neurotransmitter-related processes
MAOA	rs2072743	0.13	
miR-4482	rs45596840	0.99	
MAOA	rs1137070	0.38	
PTGS2	rs20417	0.99	
MAOB	rs1799836	0.02	
CLOCK	rs6811520	0.99	
miR-6499-5p	rs3734050	0.07	
CYP24A1	rs2248359	0.99	
CYP24A1	rs2248137	0.99	
miR-6810	rs62182086	0.94	

Table 1. Statistical results showing candidate SNPs predictors and associated SNPs obtained by logistic regression. The cut-off of significant p-value was set a p<0.05. In bold characters are reported the SNPs significantly associated with MCI. In addition, the biological pathways in which the SNPs have been implicated.

Table 2. Statistical results showing candidate SNPs predictors and associated SNPs obtained by logistic regression. The cut-off for significant p-value was set at p<0.05. In bold characters are reported the SNPs significantly associated with AD. In addition, the biological pathways in which the SNPs have been implicated.

Gene	Informative SNP	p-value	Biological pathways
MAOA	rs2072743	0.08	<ul style="list-style-type: none"> Beta-amyloid metabolism Trafficking Neuroinflammation Dopamine-related processes
MAOA	rs1137070	0.67	
VSIG4	rs1044165	1.73*10⁻⁶	
MAOB	rs1799836	0.16	
CLOCK	rs6811520	0.98	
ATF6	rs13401	0.12	
PTGS2	rs20417	0.99	
SEMA6A	rs26595	0.03	
IL6	rs1800795	0.02	
miR-4482	rs45596840	0.99	
IL2RA	rs12722489	0.05	
SLC41A1	rs1772159	0.09	

Table 2. Statistical results showing candidate SNPs predictors and associated SNPs obtained by logistic regression. The cut-off of significant p-value was set a p<0.05. In bold characters are reported the SNPs significantly associated with AD. In addition, the biological pathways in which the SNPs have been implicated.

Disorder	AUC	Sensitivity	Specificity
MCI	0.94	0.74	0.89
AD	0.93	0.64	0.94

Table 3. Accuracy, sensitivity and specificity results of the model created for classifying MCI/AD cases with respect to controls.

Conclusion: This study presents an accurate model for evaluating the risk of MCI and AD considering patient's genetic make-up. Interestingly, bioinformatic analysis highlighted a network of genes that could elucidate overlapping and specific disease mechanisms involved in the progression from MCI to AD and could therefore be exploited for drawing a trajectory of disease.

Disclosure: Nothing to disclose

EPR2174

Autosomal dominant optic neuropathy caused by pathogenic OPA1 mutation in Leber's hereditary optic neuropathy m.3460G>A mutation carriers: one family

C. Catarino¹, B. Von Livonius², K. Hörtnagel³, S. Biskup³, G. Rudolph², C. Priglinger², T. Klopstock¹
¹Neurology, Friedrich-Baur Institute, Ludwig-Maximilian University, Munich, Munich, Germany, ²Ophthalmology, Ludwig-Maximilian University, Munich, Munich, Germany, ³CeGaT GmbH, Tübingen, Germany

Background and aims: Autosomal dominant optic atrophy (ADOA) caused by OPA1 gene mutations and Leber's hereditary optic neuropathy (LHON) caused by mitochondrial mutations are both common causes of inherited bilateral visual loss, due to selective loss of retinal ganglion cells, with a different clinical course: slowly progressive for OPA1-ADOA vs. acute or subacute onset for LHON.

Methods: Clinical and genetic characterization of 1 family with several affecteds with clinically ADOA, with a pathogenic OPA1 mutation and LHON mutation m.3460G>A of the mitochondrial DNA (mtDNA).

Results: 5 family members (female index, maternal half-brother, daughter, mother and mother's brother) had childhood-onset slowly progressive visual loss and optic atrophy, compatible with ADOA. The pattern of inheritance was autosomal dominant (or maternal). 2 affecteds were reviewed in clinic, the index showed no additional neurological features, the daughter had learning difficulties. ADOA gene panel showed for both pathogenic heterozygote OPA1 mutation c.2708_2711delTTAG, causal of ADOA, and LHON mutation m.3460G>A of the mtDNA, heteroplasmic.

Conclusion: For the LHON mutation carriers in this family, the OPA1 mutation is interpreted as causal for the visual loss, given the ADOA clinical course. LHON mtDNA pathogenic mutations have incomplete penetrance (10% risk of LHON for female mutation carriers, 50% for male carriers). A contribution of the LHON mutation to the clinical phenotype cannot be affirmed in the ADOA-affecteds of this family, but LHON mutation carriership has impact for genetic counselling and would have diagnostic consequences in case of a LHON-like acute or subacute onset of rapidly progressive visual loss in this family.

Disclosure: Nothing to disclose

EPR2175

Clinical variability of variant of ataxia-telangiectasia among Bulgarian patients with mutations in ATM

T. Chamova¹, T. Todorov², D. Kancheva³, P. Yankova⁴, I. Pacheva⁵, I. Ivanov⁵, S. Cherninkova¹, D. Zlatareva⁶, V. Hadjiiska⁷, E. Naumova⁸, A. Jordanova⁹, A. Todorova¹⁰, I. Tournev¹¹

¹Department of Neurology, Sofia Medical University, University hospital "Alexandrovska", Sofia, Bulgaria, ²Genetic Medico-Diagnostic Laboratory "Genica", Sofia, Bulgaria, ³Molecular Neurogenomics Group, Department of Molecular Genetics, VIB, Antwerp, Belgium; Neurogenetics Laboratory, Institute Born-Bunge, University of Antwerp, Antwerp, Belgium; Department of Medical Chemistry and Biochemistry, Sofia, Bulgaria, ⁴Department of immunology, University Hospital "Alexandrovska", Medical University, Sofia, Bulgaria, ⁵Department of Pediatrics and Medical Genetics, Plovdiv Medical University, Plovdiv, Bulgaria, ⁶Department of Diagnostic Imaging, University Hospital "Alexandrovska", Medical University, Sofia, Bulgaria, ⁷Department of nuclear medicine, University Hospital "Alexandrovska", Medical University, Sofia, Bulgaria, ⁸Department of immunology, University Hospital "Alexandrovska", Sofia, Bulgaria, ⁹Molecular Neurogenomics Group, VIB-UAntwerp Center for Molecular Neurology, University of Antwerp, Antwerp, Belgium, ¹⁰Department of Medical Chemistry and Biochemistry; Genetic Medico-Diagnostic Laboratory "Genica", Sofia, Bulgaria, ¹¹Sofia Medical University, Department of Neurology, University Hospital Alexandrovska, Department of Cognitive Science and Psychology, New Bulgarian University, Sofia, Bulgaria

Background and aims: Ataxia telangiectasia (AT) is a multisystemic disorder caused by biallelic mutations in the ATM gene, classified in 2 main phenotypes - classic AT, leading to reduced life expectancy and loss of ambulation by the age of 10 years and a milder phenotype, known as variant AT (vAT).

To present the clinical and genetic spectrum of the Bulgarian patients with vAT.

Methods: The study encompassed 28 patients, with genetically verified vAT, from 4 pedigrees. All of them underwent neurological evaluation, neuroophthalmological, neuropsychological assessments, NCS, brain MRI and measurement of serum AFP. Immunological test were performed in 5/28.

Results: The age at onset in our group was 8.3 years \pm 9.3, varying between 14 days and 40 years. The main symptoms are dystonic and choreic hyperkinesias, static and postural tremor, more prominent in the upper limbs and the neck, dystonic disarthria and dysphagia. Mild ataxia of stance and gait was present in 5/28. Dilated conjunctival vessels were observed in 4/28. Cognition was spared. Brain imaging was normal in all affected, except in 1, with cerebellar atrophy. AFP was elevated in all tested individuals. The immunological tests revealed elevated ANA in 5/5 and absolute lymphopenia in 3/5. p.V2716A in ATM gene was

the most common mutation, found in 23 in homozygous state and in the rest 5 in compound heterozygous state.

Conclusion: Clinical features, due to mutations in ATM gene can be very broad. The disease may appear as dystonia, of early onset, without frank cerebellar involvement, but with elevated AFP.

Disclosure: Nothing to disclose

EPR2176

Action tremor as prominent neurological feature in AARS2-related ovarian failure

G. De Michele¹, M. Lieto², D. Galatolo³, M. Barghigiani³, T. Fico², F. Santorelli³, A. Filla²

¹Naples, Italy, ²Department of Neuroscience, Reproductive and Odontostomatological Sciences, Federico II University, Italy, Naples, Italy, ³Molecular Medicine, IRCCS Fondazione Stella Maris, Pisa, Italy

Background and aims: Biallelic mutations in the AARS2 gene, coding for mitochondrial alanyl-tRNA synthetase, have been associated with a severe form of infantile cardiomyopathy and, more recently, with ovarioleukodystrophy in women.

Methods: We characterized the clinical and neuroimaging phenotype of 2 sisters presenting with postural tremor and primary amenorrhea. They underwent massive multigene panel sequencing encompassing 280 genes related to ataxia.

Results: The patients, aged 31 and 25 years, presented with postural tremor, which started at the age of 18 (Patient 1) and 11 years (Patient 2). Both sisters had primary ovarian failure due to hypergonadotropic hypogonadism. Neurological examination in Patient 1 revealed downbeat nystagmus, slight tandem walking difficulty, and prominent action hand tremors. Similar features were seen in Patient 2. There was no evidence of neuropsychological impairment in both sisters. Brain MRI revealed small subcortical areas of white matters T2-hyperintensities in Patient 1 only. Targeted re-sequencing revealed that both sisters carried the c.446G>A/p.Cys149Tyr and c.385A>C/p.Thr129Pro missense mutations in compound heterozygosity. Mutations were validated by Sanger sequencing, segregated with the phenotype in the family, and their pathogenicity was confirmed in silico.

Conclusion: This work expands the phenotypic and imaging spectrum of AARS2-associated diseases, to include non-progressive tremor in absence of overt leukoencephalopathy or mental impairment.

Disclosure: Nothing to disclose

EPR2177

Patients with Cerebellar Ataxia, Vestibular Areflexia and Neuronopathy Syndrome (CANVAS) of Polynesian ancestry have a novel conformation of their RFC1 repeat.

S. Beecroft¹, A. Cortese², R. Sullivan², W.Y. Yau², Z. Dyer³, T. Wu⁴, E. Mulroy⁵, L. Pelosi³, M. Rodrigues³, R. Taylor⁶, S. Mossman⁷, R. Leadbetter⁸, J. Cleland⁹, T. Anderson⁴, G. Ravenscroft¹⁰, N. Laing¹⁰, H. Houlden², M.M. Reilly¹¹, R. Roxburgh⁵

¹Neurogenetic Diseases Group, Centre for Medical Research, QEII Medical Centre, University of Western Australia, Perth, Australia, ²UCL Institute of Neurology, London, United Kingdom, ³Neurology, Auckland City Hospital, Auckland, New Zealand, ⁴Neurology Department, Christchurch Hospital, Christchurch, New Zealand, ⁵Auckland, New Zealand, ⁶Centre for Brain Research Neurogenetics Research Clinic, University of Auckland, Auckland, New Zealand, ⁷Neurology, Wellington Hospital, Wellington Hospital, New Zealand, ⁸Neurology, Capital and Coast District Health Board, Wellington, New Zealand, ⁹Neurology Department, Tauranga Hospital, Tauranga, New Zealand, ¹⁰Harry Perkins Institute of Medical Research, University of Western Australia, Nedlands, Australia, ¹¹MRC Centre for Neuromuscular Diseases, National Hospital for Neurology and Neurosurgery and UCL Institute of Neurology, London, United Kingdom

Background and aims: Cerebellar ataxia with neuropathy and bilateral vestibular areflexia syndrome (CANVAS) is a neurodegenerative disease with onset in mid- to late adulthood. The genetic basis was recently shown to be the biallelic expansion of a pentanucleotide (AAGGG)_n repeat in RFC1. Here, we describe CANVAS genetic testing in New Zealand and Cook Island Māori.

Methods: A cohort of 28 patients - 15 European and 13 New Zealand or Cook Island Māori - clinically diagnosed with CANVAS syndrome were screened with flanking PCR testing of the RFC1 pentanucleotide expansion. In the 27 patients who were found to have no PCR product (consistent with homozygous expansion), repeat-primed PCR was performed using both reference and pathological configurations of the pentanucleotide expansion.

Haplotype analysis was performed using Illumina whole genome sequencing from which HpaMap2 makers were extracted and used in Linkdatagen and Merlin programs.

The <https://shiny.wehi.edu.au/rafehi.h/mutation-dating/> program was used to estimate the most recent common ancestors.

Results: In the New Zealand and Cook Island Māori patients there was a novel, possibly population-specific configuration of the pathogenic CANVAS AAGGG repeat embedded in the variant AAAGG repeat. They shared the same core haplotype previously described in European CANVAS patients. There were no apparent phenotypic differences.

Conclusion: Presence of a common disease haplotype among the New Zealand and Cook Island Māori suggests

this novel configuration is a founder effect with the most recent common ancestor at approximately 1430 CE. The finding of the same core haplotype as previously described, supports a single origin of the CANVAS mutation.

Disclosure: Nothing to disclose

EPR2178

Per2 C111G polymorphism influences cognition in Subjective Cognitive Decline and Mild Cognitive Impairment. A 10-year follow-up study.

G. Giacomucci¹, V. Bessi¹, S. Mazzeo¹, S. Bagnoli¹, S. Padiglioni¹, J. Balestrini¹, G. Tomaiuolo², I. Piaceri¹, M. Carraro¹, S. Sorbi¹, B. Nacmias¹

¹Department of Neuroscience, Psychology, Drug Research and Child Health, University of Florence, Florence, Italy,

²University of Florence, Florence, Italy

Background and aims: Clock and Per2 genes have been involved in sleep-wake cycle alterations and neurodegenerative diseases. We aimed to evaluate the effect of Clock T3111C and Per2 C111G polymorphisms on cognitive function and progression to AD in Subjective Cognitive Decline (SCD) and Mild Cognitive Impairment (MCI).

Methods: We included 71 subjects (43 SCD, 28 MCI), who underwent Clock and Per2 genotyping at baseline and neuropsychological follow-up at baseline and every 2 years for a mean time of 10 years. We subdivided our sample in subjects who developed AD (SCD-c, MCI-c) and non-converters (SCD-nc, MCI-nc).

Results: Clock T3111C polymorphism was detected in 46% of cases, Per2 C111G in 19% of cases (Fig.1). Per2 G carriers presented lower premorbid intelligence score ($p=0.045$), lower education ($p=0.009$) and lower frequency of family history of AD ($\chi^2=8.99$, $p=0.01$) than CC carriers (Tab.1). MCI-Per2 G carriers had worse performance in tests assessing for executive function, language and visuo-spatial abilities at baseline (Fig.2). During follow-up, 2 SCD and 14 MCI subjects progressed to AD: Clock T3111C prevalence did not differ between converters and non-converters; both SCD-c subjects presented the Per2 G allele, while none of SCD-Per2 CC carriers converted to AD ($p=0.004$).

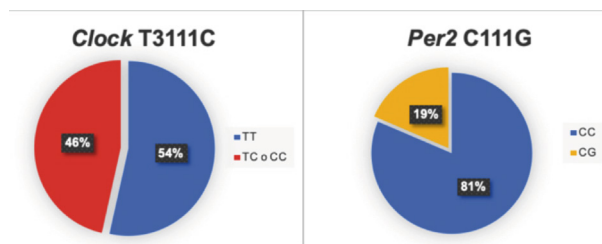

Prevalence of Per2 C111G and Clock T3111C polymorphisms

Features	Per2			Clock		
	CC carriers	G carriers	p	T carriers	C carriers	p
Age at baseline (±SD) in years	64.33 ± 9.06	65.22 ± 7.26	0.838	64.45 ± 9.18	64.02 ± 8.68	0.818
Age at onset (±SD) in years	59.95 ± 9.88	62.38 ± 7.96	0.645	60.61 ± 10.61	59.61 ± 8.75	0.782
Follow-up time (±SD) in years	10.68 ± 4.53	12.60 ± 4.68	0.207	11.27 ± 4.59	10.62 ± 4.65	0.678
Sex (females, males)	38, 19	10, 3	0.472	27, 11	22, 11	0.690
Familiarity (%)	61.4%	15.4%	0.01*	42.1%	63.6%	0.07
Education in years(±SD)	10.65 ± 4.61	7 ± 3.05	0.009*	9.92 ± 4.87	10.06 ± 4.21	0.838
TIB (±SD)	110.13 ± 8.23	104.29 ± 10.74	0.045*	110.20 ± 8.20	107.80 ± 9.45	0.424
MMSE (±SD)	28.45 ± 1.66	28.31 ± 1.49	0.591	28.08 ± 1.79	28.82 ± 1.31	0.065
ApoE4 (%)	33.4%	23.07%	0.131	28.9%	36.3%	0.647

Demographic data. Values quoted in the table are mean (±SD) or n (%). p indicates level of significance for comparison between SCD-nc and SCD-c and between MCI-c and MCI-nc (statistical significance at $p<0.05$, in bold characters).

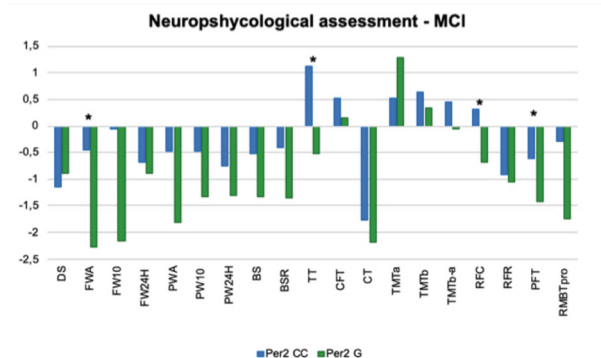

Z-score mean values for neuropsychological tests. DS-Digit Span; FWA-Five Words Acquisition; PWA-Paired Words Acquisition; BS and BSR-Babcock Short Story; TT-Token Test; CFT-Category Fluency Task; CT-Corsi Tapping Test; TMT-Trail Making Test; RFC-Rey-Osterrieth Figure copy; PFT-Phonemic Fluency Test; RBMT-Rivermead Behavioral Memory Test.

Conclusion: Per2 G carriers had lower cognitive reserve proxies, worse scores on non-memory tests, and presented less frequently family history of AD. Nevertheless, conversion to AD was more frequent in SCD-Per2 G carriers. Further studies are needed to assess the role of this polymorphism on the risk of progression to AD.

Disclosure: Nothing to disclose

EPR2179

Association between methylation of SNCA gene and rs3756063 polymorphism in patients with Parkinson's disease in Russian population

E. Iakovenko¹, N. Abramychева¹, E. Fedotova¹, S.N. Illarioshkin²

¹Neurogenetics, Research Center of Neurology, Moscow, Russian Federation, ²Russian Research Center of Neurology, Moscow, Russian Federation

Background and aims: The genetic background of Parkinson's disease (PD) is complex. Monogenic forms represent only 10-15% of PD cases. Epigenetic mechanisms and, specifically, DNA methylation can explain the mystery of "missing heritability". We studied correlation between DNA methylation of SNCA gene and PD-associated single nucleotide polymorphism (SNP) rs3756063 that it is located inside the CpG island of SNCA intron 1 and may influence the methylation process.

Methods: In total, 44 PD patients and 26 healthy controls were studied. DNA methylation was analyzed by performing bisulfate sequencing of intron 1 region of SNCA gene containing 27 CpG sites. In each CpG site, we calculated a percent of methylation: $(C/C+T)*100$. The genotype (rs3756063) was identified by direct sequencing.

Results: We found higher frequency of G allele in PD group compared to controls but the difference did not reach the significance. Multiple comparisons for all 27 CpG sites showed methylation differences between PD patients carrying C and G alleles, with significant hypomethylation for 21 CpG sites in the presence of G allele ($p<0.05$). Comparisons between PD groups with C/C, C/G and G/G genotypes showed significant difference for 18 CpG sites, with the lowest methylation in the presence of G/G genotype ($p<0.05$).

Conclusion: This is the 1st data on the association between rs3756063 and SNCA gene methylation in patients with PD from Russian population. We suggest that the presence of G allele is associated with SNCA hypomethylation and could play a role in the disease pathogenesis.

Disclosure: The study was supported by RSF 17-75-20211.

Neuroimaging 2

EPR2180

MRI as a decision support tool in a large exome sequenced limb-girdle muscular dystrophy cohort

M. Mroczek, V. Straub

Newcastle University and Newcastle Hospitals NHS Foundation Trust, John Walton Muscular Dystrophy Research Centre, Translational and Clinical Research Institute, Newcastle upon Tyne, United Kingdom

Background and aims: Muscle MRI is increasingly more available tool in diagnostic of neuromuscular disorders. Many of limb girdle muscular dystrophies (LGMDs), a heterogenous disease group associated with more than 30 genes, have muscle involvement pattern specific for a disease subtype. Here we investigate the utility of muscle MRI in assessing pathogenicity of whole exome sequencing (WES) variants in a large cohort of LGMD individuals.

Methods: In the MYO-SEQ project analysis of exome sequencing data was performed for 1891 individuals with LGMD. As part of this project we gathered 105 muscle MRIs, one muscle CT (in this case muscle MRI was not possible due to severe dyspnoea), 2 brain MRIs and 1 heart MRI. Imaging was performed in the participating centers and send to Newcastle for a second opinion.

Results: We requested MRIs for the following reasons: difficulties in assessment of pathogenicity of genetic variant (29 cases), possible pathogenic variants in 2 genes (25), novel candidate genes suspected (14), vary rare disease subtypes (10), individuals with additional phenotypic features (8) and other reasons (18). Muscle MRI was helpful in confirming/excluding variants in COL (suggestive/all considered variants in this gene 13/15) TTN (7/10) RYR1 (6/9) and CAPN3 (4/6). Overall, MRI was helpful in establishing diagnosis of 48 cases (45%). We performed theoretical studies on the whole MYO-SEQ cohort (n=1891) and, assuming 100% sensitivity and specificity, muscle MRI could contribute to diagnosis of msx. 34% of cases.

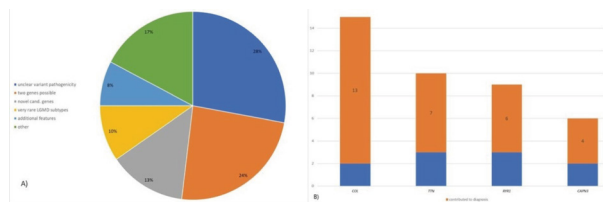

A) Reasons for requesting MRI in exome sequenced LGMD individuals
B) In orange: number of cases when MRI contributed to final diagnosis divided by variants in chosen genes

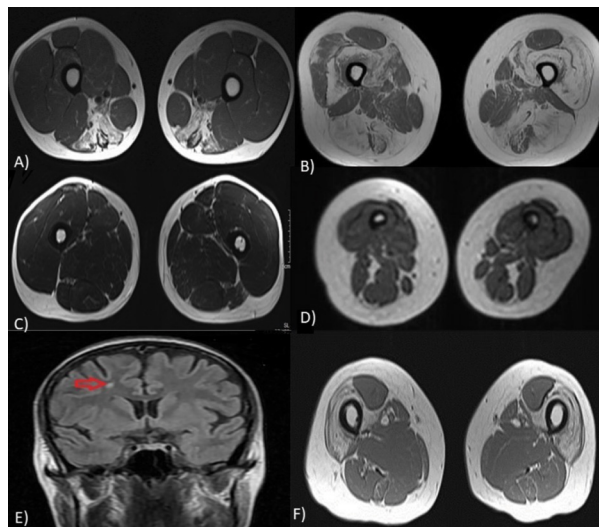

A) 1 pathogenic variant in CAPN3 and 2nd with conflicting pathogenicity (final dgn. LGMD R1) B) Hmz variant in DYSF not present in ClinVar (final dgn. LGMD R2) C) Rare, bioinformatically damaging variant in COL6 likely excluded D) COL6 variant excluded; gene list extended (dgn. PURA syndrome) E) Brain MRI in LGMD R23 F) hmc mut. in BVES

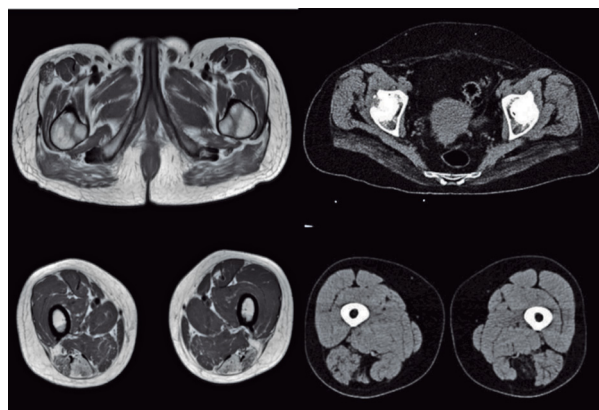

2 patients with likely pathogenic variants in a novel candidate gene (never before associated with neuromuscular diseases) and similar phenotype. Involvement of gluteus maximus, semitendinosus and semimembranosus muscle in muscle MRI (Pt 1) and muscle CT (Pt 2)

Conclusion: Muscle MRI is a powerful diagnostic tool in diagnosis of LGMD and in assessing variants generated with WES.

Disclosure: The MYO-SEQ project was funded by Sanofi Genzyme, Ultragenyx, LGMD2I Research Fund, Samantha J Brazzo Foundation, LGMD2D Foundation and Kurt+Peter Foundation, Muscular Dystrophy UK, and Coalition to Cure Calpain 3. Analysis was provided by the Broad Institute of MIT and Harvard Center for Mendelian Genomics (Broad CMG) and was funded by the National Human Genome Research Institute, the National Eye Institute, and the National Heart, Lung and Blood Institute grant UM1 HG008900 and in part by National Human Genome Research Institute grant R01 HG009141

EPR2181

Functional Connectivity measured by the Global Efficiency of the Motor Network is decreased in Parkinson's disease in comparison to Healthy Controls

N. Novaes¹, J. Balardin², L. Melo¹, J.R. Sato³, E.R. Barbosa¹, E. Cardoso⁴

¹Neurology, Universidade de São Paulo, São Paulo, Brazil, ²IIEP - Instituto Israelita de Ensino e Pesquisa, Hospital Israelita Albert Einstein, São Paulo, Brazil, ³Universidade Federal do ABC, São Paulo, Brazil, ⁴Radiology, Universidade de São Paulo, São Paulo, Brazil

Background and aims: Functional MRI is a helpful tool to study network connectivity in healthy subjects and disease. We hypothesized that motor network connectivity would be impaired in Parkinson's disease (PD) in comparison to Healthy Controls (HC), and also that both subforms of PD (Tremulant and Akinetic-Rigid) would show patterns different from each other. This study aimed to evaluate functional connectivity of areas related to tremor on the motor network of all groups.

Methods: 85 subjects (54PD, 31HC) were enrolled in this study and were submitted to structural and functional MRI. BOLD sensitive images were acquired and pre-processed using the CONN software. Important hubs of the motor network related to tremor were chosen as Regions-of-interest (ROIs). Statistical analysis was set to conservative parameters.

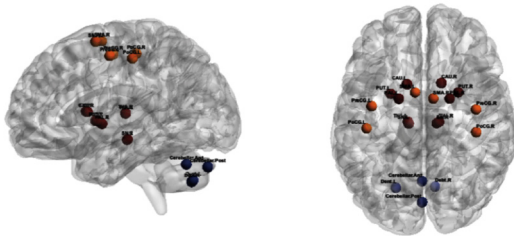

Regions of Interest (ROIs), bilaterally: In orange, cortical ROIs (Pre-central gyrus, Post-central gyrus, Supplementary Motor Area); in red, subcortical ROIs (caudate, putamen, pallidum, thalamus); in blue, cerebellar ROIs (cerebellar anterior network, cerebellar posterior network and dentate nucleus).

Results: Pairwise analysis showed no significant difference amongst groups. Network analysis demonstrated reduced global efficiency (GE) of the motor circuit of PD in comparison to HC (0.0231 versus 0.0297, p-value=0.042). Areas that most contributed for reduction were left supplementary motor area (SMAL) and bilateral post central gyrus (PostCG). No difference was found between the subgroups of PD.

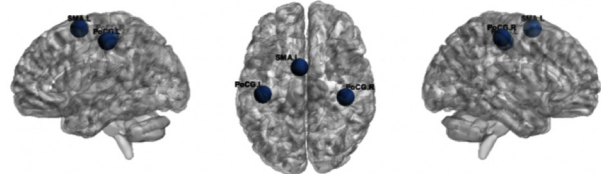

Results of Global Efficiency of the motor network in the PD group versus HC group. Blue areas are Postcentral gyrus right and left and left and right SMA.

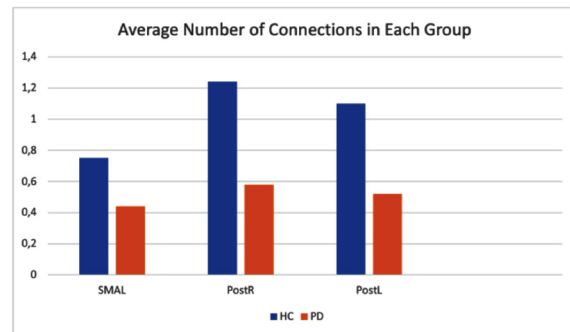

Graphic representation of the average number of connections in each group. On the x axis, the ROIs that were responsible for the difference in GE between the two groups. On the y axis, the average number of connections in each group.

Conclusion: Functional connectivity measured by the GE of the motor network is diminished in PD in comparison to HC, due to decreased connectivity of SMAL and bilateral PostCG. There is a global impairment of the motor network in PD, and it does not affect just the basal ganglia, but also areas associated with movement modulation, such as the SMA and PostCG. These could possibly be new targets for therapies such as transcranial magnetic stimulation and for posterior neuroimaging studies.

Disclosure: This project received a grant by FAPESP (Fundação de Amparo à Pesquisa do Estado de São Paulo*) and was supported by IIEP (Instituto Israelita de Ensino e Pesquisa) of the Hospital Albert Einstein**. * Foundation for Research Support of São Paulo State ** Israeli Institute of Teaching and Research of Hospital Albert Einstein

EPR2182

Diagnosis of Idiopathic Parkinson's Disease: Automated Assessment of the Substantia Nigra on Susceptibility Map-weighted Imaging Using Convolutional Neural Networks

H.-M. Park¹, Y. H. Sung¹, J. Yang², E. Y. Kim³
¹Incheon, Korea, Republic of, ²Department of Neurology, Gachon University Gil Medical Center, Incheon, Korea, Republic of, ³Department of Radiology, MD, PhD, Incheon, Korea, Republic of

Background and aims: It has been reported that degeneration in the substantia nigra (SN) in idiopathic Parkinson's disease (IPD) can be determined by visually assessing susceptibility-weighted imaging (SWI). Our study aims to implement and evaluate a convolutional neural networks (CNN)-based method for assessing the SN on susceptibility map-weighted imaging (SMWI).

Methods: In this retrospective study, we enrolled 296 patients with dopamine transporter (DAT) imaging-proved IPD and 183 subjects with normal DAT activity from our institute. All subjects underwent both 3-echo time GRE imaging for SMWI. We developed a CNN-based algorithm for determining abnormality in the SN on SMWI. DAT imaging served as a reference standard. Diagnostic performance was tested per SN and per participant by using the receiver operating characteristic (ROC) curve analysis. The results from the CNN-based algorithm in the internal dataset were compared with the interpretations from two reviewers.

Results: The mean value of the 5 areas under the ROC curve (AUC) produced by 5-fold cross-validation was 0.992 (standard deviation, 0.0006) from our dataset by the CNN-based algorithm. The diagnostic sensitivity and specificity for nigral degeneration by the reviewers were 96.05% and 96.67% (per SN) and 99.12% and 93.33% (per participant), respectively from our dataset, and 100% and 100% (per SN) and 100% and 100% (per participant), respectively from the dataset for external validation. These results did not show significant difference.

Conclusion: Our CNN-based algorithm shows high diagnostic performance for detecting nigral degeneration in IPD, which is comparable with that by visual interpretation.

Disclosure: Nothing to disclose

EPR2183

Patterns of Cerebellar Atrophy and Resting State Functional Connectivity Changes in Relapsing-Remitting MS Patients Starting Fingolimod and Natalizumab: A 2-Year Study

P. Preziosa¹, P. Valsasina¹, L. Storelli¹, E. Pagani¹, L. Moiola², M. Rodegher², M.A. Rocca¹, M. Filippi¹
¹Neuroimaging Research Unit, Institute of Experimental Neurology, Division of Neuroscience; and Neurology Unit, IRCCS San Raffaele Scientific Institute, Milan, Italy, ²Neurology Unit, IRCCS San Raffaele Scientific Institute, Milan, Italy

Background and aims: Fingolimod and natalizumab are effective treatments for relapsing-remitting multiple sclerosis (RRMS). We compared their effects on cerebellar atrophy and resting state (RS) functional connectivity (FC) in RRMS after two years of treatment.

Methods: RRMS patients starting fingolimod (n=23) or natalizumab (n=27) underwent 3T MRI scans at month 0 (M0), 6 (M6), 12 (M12) and 24 (M24). 15 healthy controls (HC) were also acquired at M0 and M24. Baseline and longitudinal changes of cerebellar volume (SUIT, SPM12 a Jacobian integration method) and RS FC (seed-based analysis from bilateral CrusI/CrusII) were estimated.

Results: At M0, no cerebellar volumetric difference was found, while patients' groups showed a reduced intra-cerebellar, inter-cerebellar and thalamo-cerebellar RS FC vs HC. Fingolimod-patients experienced significant cerebellar atrophy compared to natalizumab-patients at M6 vs M0 (-1.28% vs -0.06%), M24 vs M6 (-1.38% vs +0.01%) and M24 vs M0 (-0.93% vs -0.10%) and compared to HC (-0.29%) at M24 vs M0 (p<0.001). While RS FC was longitudinally stable in HC, patients' groups showed a reduced cerebellar RS FC with fronto-parietal regions and an increased cerebellar RS FC with bilateral cerebellar regions and deep grey matter. In natalizumab-patients, longitudinal RS FC changes were linear and independent from atrophy. In fingolimod-patients, cerebellar RS FC mainly decreased at M6, while after M6 it mainly increased and was associated with lower cerebellar atrophy progression.

Conclusion: Natalizumab is superior to fingolimod in limiting cerebellar atrophy progression. Both drugs promote cerebellar networks reorganization. Increased RS FC may compensate cerebellar structural damage accumulation.

Disclosure: Nothing to disclose

EPR2184

Brain perfusion changes in Alzheimer's disease networks and their association with pathophysiological features in amnesic mild cognitive impairment patients.

G. Quattrini¹, M. Marizzoni¹, F.B. Pizzini², I. Boscolo Galazzo³, M. Didic⁴, A. Soricelli⁵, P.J. Nathan⁶, J. Richardson⁷, O. Blin⁸, G.L. Forloni⁹, D. Albani¹⁰, J. Jovicich¹¹, M. Salvatore⁵, G. Frisoni¹², M. Pievani¹

¹Laboratory of Alzheimer's Neuroimaging and Epidemiology, IRCCS Fatebenefratelli, Brescia, Italy, ²Radiology, Dept. of Diagnostic and Public Health, University of Verona, Verona, Italy, ³Department of Computer Science, University of Verona, Verona, Italy, ⁴Inserm, Institut de Neurosciences des Systèmes (INS) UMR_S 1106, Aix-Marseille Université, Marseilles, France, ⁵IRCCS SDN, Naples, Italy, ⁶Sosei Heptares, Cambridge, United Kingdom, ⁷Neurosciences Therapeutic Area, UK, United Kingdom, ⁸Aix-Marseille University-CNRS, Marseilles, France, ⁹Neuroscience Department, IRCCS Istituto di Ricerche Farmacologiche "Mario Negri", Milan, Italy, ¹⁰Neuroscience Department, IRCCS Istituto di Ricerche Farmacologiche "Mario Negri", Milan, Italy, ¹¹Center for Mind/Brain Sciences, University of Trento, Trento, Italy, ¹²Laboratory of Neuroimaging of Aging, University of Geneva, Geneva, Switzerland

Background and aims: Previous studies found brain perfusion changes in amnesic mild cognitive impairment (aMCI) patients in cortical regions included in the default mode network (DMN) (posterior cingulate cortex and precuneus) and the limbic network (LIN) (hippocampus). However, no study investigated the perfusion within the DMN and LIN and its relationship with Alzheimer's disease (AD) features.

Methods: We collected the apolipoprotein E (APOE) status, cerebrospinal fluid (CSF) beta-amyloid 42, phosphorylated tau and total tau levels, 3T MRI features (hippocampal volumes and cortical thickness from T1-weighted, white matter hyperintensities on FLAIR), and associative learning and memory functioning on the paired associate learning (PAL) task in 14 aMCI (age, years: 72.8±7.2; Mini-Mental State Examination: 26.1±1.8), recruited in the PharmaCog study. Cerebral Blood Flow (CBF) was extracted from the DMN, LIN, somatomotor (SMN), and visual (VIS) networks using arterial spin labelling (ASL) and were correlated with CSF measures, MRI features, PAL performance (number of errors), and APOE status.

Results: Perfusion was reduced in the DMN (Mann-Whitney, U=8, p=0.043) and LIN (U=3, p=0.005) in APOE ε4 carriers (N=8) compared to non-carriers (N=6). Moreover, LIN perfusion was associated with CSF beta-amyloid 42 level (rho=0.818, p=0.001), and associative learning and memory impairment (rho=-0.621, p=0.024). No association was detected with MRI markers and vascular burden, nor between perfusion in SMN and VIS and the investigated features.

Conclusion: Our results confirm an association between CBF reduction in AD networks and AD pathophysiological features in aMCI, supporting an involvement of brain perfusion in upstream AD processes.

Disclosure: Nothing to disclose

EPR2185

White Matter Abnormalities in Obstructive Sleep Apnea are reversible after CPAP-treatment

M. Salson¹, M.E. Caligiuri², V. Castronovo³, N. Canessa⁴, S. Marelli³, A. Quattrone², L. Ferini-Strambi³

¹Neuroimaging Unit, National Research Council, Catanzaro, Italy, ²Neuroscience Center, University "Magna Graecia", Catanzaro, Italy, ³Department of Clinical Neurosciences, Neurology - Sleep Disorders Center, IRCCS San Raffaele Scientific Institute, Milan, Italy, ⁴NEtS Center, Scuola Universitaria Superiore IUSS, Pavia, Italy

Background and aims: Recent evidences demonstrated the role of white matter (WM) lesions in the pathogenesis of Obstructive Sleep Apnea (OSA), a clinical entity characterized by repetitive collapse of the upper airway during sleep. However, the involvement of silent WM lesions as well as the brain morphologic modifications after treatment still remains unknown. This study aimed to investigate the microstructural integrity of normal appearing white matter (NAWM) in OSA patients before and after CPAP-treatment, using a neuroimaging approach.

Methods: Magnetic resonance imaging data were acquired from a total of 17 never-treated OSA patients. Diffusion tensor imaging (DTI) and Tract-based spatial statistics (TBSS) were performed to assess microstructural NAWM changes. In order to assess the therapy efficacy, OSA patients underwent MRI evaluations at 2 time-points, baseline and after 3 months of CPAP treatment.

Results: CPAP treatment significantly increased fractional anisotropy in NAWM of brainstem, in the corpus callosum and in bilateral internal capsule of patients with OSA at follow-up compared to baseline ($p < 0.05$ TFCE-corrected). Moreover, patients with OSA also showed increases of axial diffusivity in the major tracts of the right hemisphere ($p < 0.05$ TFCE-corrected) after CPAP treatment compared to baseline.

Conclusion: This study improves the knowledge on the therapy efficacy with CPAP in OSA patients, as our results demonstrate that DTI metrics of NAWM in major tracts such as the corpus callosum and the internal capsule were significantly increased after CPAP treatment. This could represent a potential beneficial effect of therapy with CPAP.

Disclosure: Nothing to disclose

EPR2186

Plaque perfusion and elastography in carotid vulnerable plaque detection

D. Školoudík¹, M. Kral², J. Vomáčka³, T. Hrbac¹, D. Netuka⁴, D. Vaclavik⁵

¹Ostrava, Czech Republic, ²Olomouc, Czech Republic, ³Radiology, University Hospital Olomouc, Olomouc, Czech Republic, ⁴Neurosurgery, Military University Hospital Prague, Prague, Czech Republic, ⁵Agel Research and Training Institute, Ostrava Vitkovice Hospital, Ostrava, Czech Republic

Background and aims: Vulnerable plaque diagnostics is still a challenge. The aims of the study were to correlate density plaque perfusion with plaque elastography and symptoms of stenosis.

Methods: Patients with carotid stenoses $\geq 50\%$ were included to the study. Duplex sonography of carotid plaque with B-mode, color mode, Doppler mode, plaque perfusion without contrast agent and plaque elastography examinations were performed in all patients. Plaque perfusion was evaluated visually in 5-point scale. Correlation between plaque perfusion and elastography results, symptoms in corresponding carotid territory and plaque progression were statistically evaluated.

Results: Totally 78 patients (39 males; age 67.7 ± 9.0 years) with 97 carotid stenoses $\geq 50\%$ (21 symptomatic, 13 asymptomatic progressive and 63 asymptomatic stable stenoses) were included to the study. No, minimal, low, moderate and major plaque perfusion were detected in 8, 20, 33, 25 and 11 plaques, resp. Weak correlation between plaque perfusion and plaque elastography was detected ($r = 0.37$, $r < 0.01$). Plaque with no/minimal perfusion were less frequently heterogenous (28.6% vs. 68.9%), ulcerated (0% vs. 20.7%), and symptomatic (14.3% vs. 40.6%), had lower elasticity (55.0 vs. 86.4) and were detected less frequently in patients with diabetes mellitus (14.3% vs. 36.2%).

Conclusion: Symptomatic carotid stenoses have higher density of plaque perfusion compared with asymptomatic stenoses.

Disclosure: Supported by the Ministry of Health of the Czech Republic grant No. 17-31016A.

EPR2187

Neural correlates of (non-)behavioural signs of consciousness – what can we learn from resting state neuroimaging?

A. Thibaut¹, R. Panda², O. Gosseries¹, C. Martial¹, C. Aubinet¹, H. Cassol³, G. Martens¹, M. Carrière¹, A. Wolff¹, A. Barra³, L.R.D. Sanz¹, C. Chatelle¹, S. Laureys¹

¹Liege, Belgium, ²Coma Science Group, Université de Liège, Liege, Belgium, ³Giga Consciousness, ULiege, Liege, Belgium

Background and aims: Unresponsive patients at the bedside may present covert consciousness. This retrospective cross-sectional study aimed to determine brain regions needed to demonstrate behavioural signs of consciousness.

Methods: We looked at the 18fluorodesoxyglucose Positron Emission Tomography (FDG-PET-scan) of 96 patients with disorders of consciousness (see table 1). All patients were assessed 5 times with the Coma Recovery Scale-Revised. The diagnosis of MCS* was based on the FDG-PET relative preservation of global brain metabolism as assessed by 3 experts. We compared brain metabolism of patients in MCS* to UWS and MCS and performed seed-based connectivity analyses. MRI and EEG data were also analysed. Prognosis was collected using the Glasgow Outcome Scale Extended.

Results: Out of the 35 behavioural UWS, 22 presented a partial preservation of brain metabolism (i.e., patients in MCS*), specifically in the fronto-parietal networks (Fig 1 – left). Patients in MCS* had more hypometabolism in the right posterior regions (Fig 1 – right). We found a higher correlation between the right superior temporal gyrus (seed) and motor cortices, somato-sensory associative areas, prefrontal area, and the thalami in MCS compared to MCS*(Fig 2), as well as a higher connectivity (EEG) in the theta band in the left hemisphere. Finally, MCS* patients had a 50% chance to recover signs of consciousness (MCS) at follow-up, while no patient in UWS improved.

Conclusion: Many patients clinically unresponsive may present covert consciousness. The integrity of the connectivity between the superior temporal gyrus and sensori-motor regions, prefrontal cortex and thalami is crucial to clinically demonstrate signs of consciousness.

	UWS (n=13)		MCS* (n=22)		MCS (n=59)	
Gender	7 men (57%)		11 men (50%)		32 men (54%)	
Aetiology(%TBI)	0 TBI (0%), 9 anoxia, 1 stroke, 3 mixed		10 TBI (43%), 6 anoxia, 3 stroke, 2 mixed, 1 meningitis		33 TBI (57%), 11 anoxia, 10 stroke, 4 mixed, 1 meningitis	
Age – mean±SD min-max	52±14 – 30-74 years old		40±14 – 21-73 years old		40±14 – 18-78 years old	
TSO – mean±SD min-max	551±517 – 1715 days	36-	354±244 – 2009 days	28-	760±606 – 4786 days	32-
CRS-R total score – median±IQR min-max	6±1 – 2-6		5±2 – 4-8		12±3 – 4-21	
% preserved – mean±SD min-max	27.07±7.27 – 9.13- 36.96%		46.11±6.84 – 36.56±75.40%		55.69±11.29 – 30.76- 83.27%	

Table1: Clinical characteristics of DOC patients included in the PET-scan analyses.

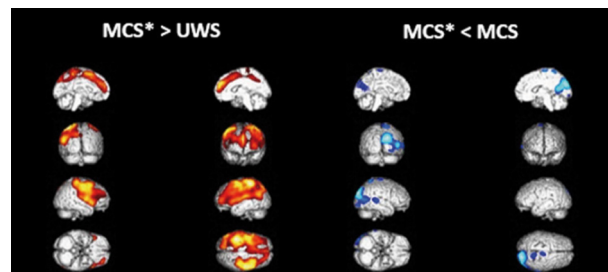

MCS* compared to UWS presented higher brain metabolism in the frontoparietal network, mesiofrontal area, anterior and posterior cingulate cortices, and the precuneus (left – red). Compared to MCS, they presented lower brain metabolism in the precuneus, the right supplementary motor area, superior temporal gyrus and visual cortex (right – blue).

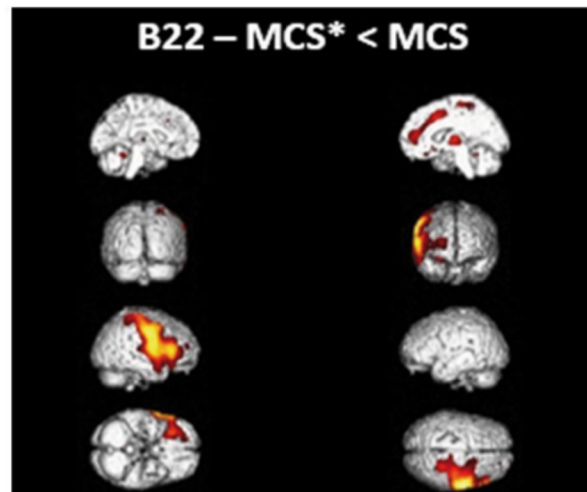

Brain regions showing higher connectivity with B22 (right superior temporal gyrus) in MCS as compared to MCS* (in red), namely the premotor and supplementary motor cortices, the somatosensory associative areas, the dorsolateral prefrontal cortex, the inferior frontal gyrus and the thalami.

Disclosure: Nothing to disclose

EPR2188

Neuroanatomic Correlates of Angioedema in stroke patients with thrombolysis

K. Winder¹, B. Kallmünzer², A. Dörfler³, M.J. Hilz¹, S. Schwab⁴, F. Seifert⁵, K. Fröhlich⁵

¹Erlangen, Germany, ²Department of Neurology, University of Erlangen-Nuremberg, Erlangen, Germany,

³Neuroradiology, Friedrich-Alexander University Erlangen-Nürnberg, Erlangen, Germany, ⁴Department of Neurology, Universitätsklinikum Erlangen, Erlangen, Germany,

⁵Neurology, Friedrich-Alexander University Erlangen-Nürnberg, Erlangen, Germany

Background and aims: **Background:** Oral angioedema (OA) is a rare, but life-threatening complication in ischemic stroke patients receiving intravenous thrombolysis with recombinant tissue plasminogen activator. This study intended to determine associations between thrombolysis-related OA and ischemic stroke lesion-sites using a voxel-wise lesion analysis.

Methods: Prospective registry data were used to identify ischemic stroke patients with thrombolysis-related OA between 2002 and 2018. Ischemic stroke patients with thrombolysis-treatment but without OA admitted in the years 2011 and 2012 comprised the control group. Ischemic lesions were manually outlined on magnetic resonance imaging (1.5 or 3T) or computed tomography scans, and transformed into stereotaxic space. We determined the lesion overlap and compared the absence or presence of OA voxel-wise between patients with and without lesions in a given voxel using the Liebermeister test. Stroke severity was rated using the National Institute of Health Stroke Scale (NIHSS) score and blood-pressure, heart rate, blood glucose levels, and body temperature were determined on admission.

Results: 15 ischemic stroke patients with thrombolysis-related OA were identified. The voxel-wise analysis yielded associations between OA and ischemic lesions in the insulo-opercular region with a right-hemispheric dominance. Mean blood-pressure was significantly lower in patients with oral angioedema than in controls. Age, NIHSS-scores, infarct volumes, heart rate, and blood glucose levels did not differ between patients with and without OA.

Conclusion: The voxel-wise analysis linked thrombolysis-related OA to right insulo-opercular lesions. The lower blood-pressure in patients with thrombolysis-related OA may reflect bradykinin-effects causing vasodilatation and increasing vascular permeability.

Disclosure: Nothing to disclose

EPR2189

The use of muscle MRI in the diagnosis of neuromuscular diseases

S. Xirou¹, C. Lopes², C. Bolano³, V. Straub⁴, C. Marini Bettolo⁴

¹First Department of Neurology, Aeginition Hospital, National and Kapodistrian University of Athens, Greece.,

Athens, Greece, ²Department of Neurology, Centro Hospitalar e Universitario de Sao Joao, Porto, Portugal, Porto, Portugal, ³Favaloro Foundation university hospital, Buenos Aires, Argentina, ⁴John Walton Muscular Dystrophy Research Centre, Institute of Genetic Medicine, Newcastle University, Centre for Life, Newcastle, United Kingdom, Newcastle Upon Tyne, United Kingdom

Background and aims: Inherited neuromuscular disorders (NMD) are a heterogeneous group of disorders characterized by progressive muscle weakness, different pattern of muscle involvement, age of onset. Thanks to next generation sequencing the numbers of genes responsible for NMD is growing. In recent years muscle MRI has contributed to the diagnosis by evaluating the selective pattern of muscle involvement.

Methods: We retrospectively reviewed the muscle MRI of 533 individuals (age 5-93 years) performed at the John Walton Muscular Dystrophy Research Centre in Newcastle. All patients underwent a muscle MRI, using T1 weighted and STIR axial sequences of the lower limbs. We reviewed the clinical notes and genetic results and correlated to the muscle MRI.

Results: In 83.5% the muscle MRI was performed to direct genetic testing, in 9% to support genetic results, in 5% for academic reasons in already diagnosed patients and in the remaining 2.5% data was missing. The muscle MRI was helpful in directing genetic testing in 48 (11%) cases. Overall, 363/533 (68%) remain genetically undiagnosed whilst 170/533 (32%) had a genetically confirmed diagnosis. The most frequent diagnosis were LGMD 36%, congenital myopathies 22%, FSHD 5%, myofibrillar myopathies 4%, other distal myopathies 14% and others 19%.

Conclusion: Muscle MRI appears to be a useful diagnostic tool to achieve a diagnosis in neuromuscular conditions. Some cases remain still undiagnosed and there is still to learn about selective pattern of muscle involvement in these rare conditions.

Disclosure: Nothing to disclose

EPR2190

Evaluation of the Usefulness of SMwI nigrosome 1 MRI for Differentiating Subclinical Parkinson's disease in Idiopathic REM Sleep Behavior Disorder

J. Yang¹, Y.H. Sung², H.-M. Park², E.Y. Kim³

¹Department of Neurology, Gachon University Gil Medical Center, Incheon, Korea, Republic of, ²Incheon, Korea, Republic of, ³Department of Radiology, MD, PhD, Incheon, Korea, Republic of

Background and aims: Many patients with assumed idiopathic REM sleepbehavior disorder (iRBD) develop Parkinson's disease (PD), multiple system atrophy (MSA) or diffuse Lewy body dementia (DLB), iRBD is not an independent degenerative disease. RBD is an important prodromal symptom of PD with anosmia and constipation. The present study was performed to probe the susceptibility map-weighted imaging (SMwI) nigrosome1 MRI as neuroimaging biomarker to identify prodromal PD in subjects with iRBD.

Methods: This local ethics committee-approved prospective study enrolled 21 patients with iRBD and 20 healthy subjects who underwent both SMwI at 3T and 18F-FP-CIT PET. The demographic and clinical characteristics of the two group were compared by Mann-Whitney U test. The concordance rate was tested using Cohen's kappa.

Results: Nigrosome1 was intact in 11 patients with iRBD and lost in 9. This shows that 48% of iRBD patients are in subclinical PD. SMwI and 18F-FP-CIT PET results exhibited similar diagnostic performance and had excellent agreement ($k=0.809$ per participant). The disease duration of RBD was significantly different between iRBD with or without nigrosome1 loss. iRBD with nigrosome1 loss was approximately twice longer disease duration compared to iRBD without nigrosome1 loss.

Conclusion: SMwI nigrosome1 MRI is useful to detect early in the preclinical stage of PD in patients with iRBD.

Disclosure: Nothing to disclose

Neuroimmunology 2

EPR2191

Anti-CD20 therapy suppresses cortical pathology in a new rat model of cortical demyelination

M.T. Haindl¹, M. Üçal², B. Klaus², L. Tögl²,
J. Dohrmann¹, M.Z. Adzemovic³, C. Enzinger¹,
S. Hochmeister¹

¹Department of general Neurology, University of Neurology, Graz, Austria, ²Department of Neurosurgery, Research Unit of Experimental Neurotraumatology, Graz, Austria,

³Department of Clinical Neuroscience, Center for Molecular Medicine, Stockholm, Sweden

Background and aims: Cortical demyelination is a prominent feature of the multiple sclerosis (MS) brain in the progressive stage and is believed to be a substrate for diffuse cognitive impairment. We recently developed a rat model (Ücal et al., 2017) which reassembles most of the cellular features of brain pathology in progressive MS. B-cell depleting anti-CD20 therapy is effective in the relapsing remitting course of MS as well as in the early progressive stage. The aim of this study was to increase our understanding for the mode of action of B-cells on cortical lesions in our new rat model and whether anti-CD20 therapy can prevent the formation of cortical demyelination.

Methods: Anti-CD20 therapy was administered by intravenous injection into the tail base vein after (Group 1) or before (Group 2) myelin oligodendrocyte glycoprotein (MOG) immunization. Rats were sacrificed at peak disease and brain tissues were analysed in histology with respect to extent of cortical demyelination, microglial activation, neuronal cell loss and astrocytic reactivity.

Results: Histological analyses revealed that the anti-CD20 therapy averted the cortical pathology with significant reductions in demyelination, microglial activation, neuronal loss and astrocyte activation compared with the animals that were treated with an isotype control antibody. Anti-CD20 therapies applied before or after MOG immunization were equally efficacious.

Conclusion: Our results show a favourable impact of the anti-CD20 therapy on preservation of the investigated cortical structures. These findings pave the way for further research on the mode of action of B-cells and might help to improve therapeutic strategies for progressive MS patients.

Disclosure: Nothing to disclose

EPR2192

Safety of autologous hematopoietic stem cell transplantation in multiple sclerosis patients (aHSCT-in-MS): the Zurich experience

I. Jelcic¹, A.M. Müller², P. Stathopoulos¹,
N. Wolfensberger², A. Thesenvitz¹, K. Ritter²,
A. Lutterotti¹, U. Schanz², R. Martin¹

¹Neurology Clinic, University Hospital Zurich, Zurich, Switzerland, ²Department of Medical Oncology and Hematology, University Hospital Zurich, Zurich, Switzerland

Background and aims: Autologous hematopoietic stem cell transplantation (aHSCT) is used for the treatment of highly-active relapsing-remitting or progressive multiple sclerosis (MS) since 1995. Based on strong data regarding efficacy and improved safety of aHSCT in MS, the Swiss Federal Office of Public Health (FOPH) granted approval in June 2018 with the requirement that patients participate in a prospective registry study at our institution (“aHSCT-in-MS”).

Methods: We used cyclophosphamide and filgrastim to mobilize hematopoietic stem cells and BEAM-ATG regimen for conditioning high-dose chemotherapy.

Results: Until now, 22 MS patients (11 females, 11 males) received aHSCT. Patients had a mean age of 41.3±7.7 years, mean disease duration of 8.6±4.9 years and a mean expanded disease status scale (EDSS) score of 5.0±1.2. 7/22 patients had relapsing-remitting MS, 8/22 secondary-progressive MS and 7/22 primary-progressive MS. All patients had either clinical activity (i.e. relapses, 5/22 of patients), radiological activity (7/22) and/or clinical progression (14/22) before aHSCT, despite conventional highly effective immunomodulatory therapy. The majority of patients developed infectious adverse events (AE), i.e. mucositis and/or enteritis (20/22), upper airway (4/22) and urinary (4/22) infection, reactivation of CMV (2/22), HSV (3/22), VZV (1/22) and BKV (2/22). Other AEs included Uhthoff's phenomenon (7/22), hypotension (3/22), epistaxis and cholecystolithiasis (each 1/22). Severe AEs included 2 additional, symptomatic CMV reactivations, each 1 hemorrhagic cystitis, gastroenteritis with ileus, laryngitis, cervical abscess, pulmonary embolism, gastrointestinal bleeding, manic episode.

Conclusion: Overall, safety of aHSCT-in-MS is acceptable. However, aHSCT-in-MS requires vigilant monitoring (especially regarding infectious diseases) and optimized antimicrobial prophylactic care.

Disclosure: Nothing to disclose

EPR2193

The microbiome of the nasal cavity in multiple sclerosis: another source of autoimmune response?

D. Kasatkin¹, I. Dukhanina¹, I. Dukhanina²,
N. Bogomolova², V. Shadrichev¹, E. Shipova¹

¹Neurology, Yaroslavl State Medical University, Yaroslavl, Russian Federation, ²Microbiology, Yaroslavl State Medical University, Yaroslavl, Russian Federation

Background and aims: Intestinal microbiome plays a significant role in the pathogenesis of autoimmune diseases, including MS. Significant also seems to be the influence of the microflora of the nasal sinuses, since the nasal cavity has direct bony channels with the cranial cavity. The role in the antigen presentation of the pharyngeal lymphoid ring is also high. Aim was to evaluate the composition of sinuses and nasal microbiome.

Methods: 28 MS patients (78% females), relapsing-remitting, remission (all 1st line injectable drugs) and 15 healthy subjects (hospital staff). Exclusion: 1) signs of acute upper way respiratory infection, 2) chronic sinusitis or nasopharyngitis, 3) taking medications that affect microbiome (local or system antibiotics) for last 3 months, 4) severe comorbidity. EDSS, course of disease, standard nasoscopic procedure for taking biological samples, culture inoculation with an assessment after 5 days, evaluation of antimicrobial resistance. Statistical analysis – Chi-square, ANOVA.

Results: 93% of patients and only 36% of control have deviant microbiome. Normal microflora was presented by *Staphylococcus epidermidis* (7.1% vs 92.7%, $p < 0.001$). The only pathological bacteria in healthy control was *Staphylococcus aureus* (35.7%). Abnormal patient microbiome consists of *Staphylococcus aureus* (60.7%), *Enterobacter* (21.4%), *Escherichia coli* (21.4%) and *Candida* (57.1%). The quantitative representation of conditionally pathogenic strains significantly increases with the duration of the disease ($p = 0.02$), as well as a EDSS score ($p = 0.03$). The composition of microflora does not depend on gender, age and type of drug, and detected even with clinically isolates syndrome.

Conclusion: Nasal microbiom of patients with MS significantly deviate normal and may play role in course of disease.

Disclosure: Nothing to disclose

EPR2194

No change in risk of infection among NMOSD and refractory gMG patients treated with eculizumab: findings from two phase 3 studies and their extensions

R.E. Mantegazza¹, T.D. Levine², C. Oreja-Guevara³,
C. Carrillo-Infante⁴, S. Shang⁴, R. Kaprielian⁵,
S.J. Pittock⁶, J.F. Howard Jr⁷

¹Fondazione IRCCS Istituto Neurologico Carlo Besta, Milan, Italy, ²Phoenix Neurological Associates, Phoenix, USA,

³Hospital Universitario Clinico San Carlos, Madrid, Spain,

⁴Alexion Pharmaceuticals, Boston, USA, ⁵Alexion Pharmaceuticals, Vaughan, Canada, ⁶Mayo Clinic,

Rochester, USA, ⁷Dept of Neurology, University of North Carolina, Chapel Hill, USA

Background and aims: PREVENT (NCT01892345) and REGAIN (NCT01997229) were phase 3, randomized, double-blind studies comparing efficacy and safety of eculizumab and placebo in patients with aquaporin-4 antibody-positive (AQP4+) neuromyelitis optica spectrum disorder (NMOSD) and refractory acetylcholine-receptor antibody-positive (AChR+) generalized myasthenia gravis (gMG), respectively. We report infection rates in patients treated with eculizumab with or without concomitant immunosuppressant therapy (IST) in PREVENT, REGAIN and respective open-label extensions (NCT02003144 [interim data] and NCT02301624).

Methods: Patients were vaccinated against *Neisseria meningitidis* and randomized to eculizumab (maintenance dose, 1200mg/2 weeks) or placebo, with stable-dose concomitant ISTs permitted. Pooled infection rates were analysed post hoc for subgroups determined by number of baseline ISTs (0, 1, 2 or ≥ 3).

Results: The numbers of patients exposed to eculizumab/placebo were 137/47 (NMOSD; 276.6/51.5 patient-years) and 123/63 (gMG; 304.4/31.1 patient-years). There were no differences in infection or serious infection rates with extent of IST use (Table) nor an increase in infection risk with long-term eculizumab therapy (data will be presented); although, patient numbers were small in some subgroups. Similar infection types were observed in patients receiving eculizumab for each indication (total $n = 260$): most commonly nasopharyngitis ($n = 76$), upper respiratory tract infections ($n = 67$), urinary tract infections ($n = 44$) and influenza ($n = 39$) (Figure). There was one case of meningococcal meningitis (encapsulated) in a patient with gMG receiving eculizumab (2 IST subgroup); this resolved with antibiotic treatment and eculizumab was reinstated.

Table 1. Infection and serious infection rates by baseline IST use

	Infection rates/100 PY (N)				Serious infection rates*/100 PY (N)			
	NMOSD		gMG		NMOSD		gMG	
	Eculizumab	Placebo	Eculizumab	Placebo	Eculizumab	Placebo	Eculizumab	Placebo
No ISTs	192.1 (35)	192.2 (13)	238.2 (2)	305.6 (2)	1.4 (35)	8.0 (13)	0.0 (2)	0.0 (2)
1 IST	183.6 (55)	154.1 (22)	230.6 (41)	253.1 (18)	13.9 (55)	7.0 (22)	16.3 (41)	34.5 (18)
2 ISTs	195.1 (47)	266.7 (12)	171.7 (78)	192.5 (41)	15.1 (47)	47.6 (12)	13.4 (78)	24.1 (41)
≥3 ISTs*	-	-	98.0 (2)	100.1 (2)	-	-	14.0 (2)	0.0 (2)

Infection rates shown per 100 PY to standardize for differences in treatment exposure.
 *A serious adverse event (experience) or reaction was defined as any untoward medical occurrence that, at any dose: results in death; is life-threatening; requires inpatient hospitalization or prolongation of existing hospitalization; results in persistent or significant disability/incapacity; is a congenital anomaly/birth defect; or is an important medical event.
 †No patients with NMOSD were receiving ≥3 ISTs at baseline.
 gMG, generalized myasthenia gravis; IST, immunosuppressant therapy; N, total number of patients in category; NMOSD, neuromyelitis optica spectrum disorder; PY, patient-years.

Figure 1. Most common infections in patients with NMOSD (PREVENT + extension) and gMG (REGAIN + extension)

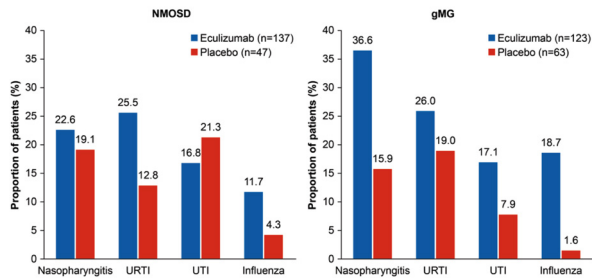

Some patients provided data for both the eculizumab group and the placebo group if they were receiving placebo in REGAIN/PREVENT and then eculizumab in the extension study.
 gMG, generalized myasthenia gravis; NMOSD, neuromyelitis optica spectrum disorder; URTI, upper respiratory tract infection; UTI, urinary tract infection.

Conclusion: In these complement-mediated neurological conditions, overall risk and types of infections were similar in the eculizumab and placebo groups, regardless of concomitant IST.

Disclosure: Research funding for this study was provided by Alexion Pharmaceuticals.

EPR2195

Detection of novel CNS-specific antibodies using human induced pluripotent stem cells-derived astrocytes and neurons: a pilot study on autoimmune-mediated neurological syndromes

A. Mathias¹, S. Perriot¹, S. Jones¹, N. Torcida¹, M. Canales¹, M. Theaudin¹, C. Pot¹, R. Du Pasquier²
¹CHUV, Lausanne, Switzerland, ²Lausanne, Switzerland

Background and aims: The last decade has seen a thrilling rise in the discovery of CNS-reactive autoantibodies involved in neurological disorders. The identification of such autoantibodies has led to profound changes in therapeutic approaches. Nevertheless, about 10% of the patients developing autoimmune limbic encephalitis remain seronegative for all currently known CNS antigens. Here, we developed a cell-based assay (CBA) to screen for the presence of novel CNS-specific antibodies in sera and cerebrospinal fluid (CSF) using CNS cells derived from human-induced pluripotent stem cells (hiPSC).

Methods: Human iPSC-derived astrocytes and neurons were incubated with paired serum/CSF of 109 patients suffering from inflammatory neurological diseases (IND) and 19 patients with non-IND (NIND). IgG bound to CNS cells were detected using a combination of fluorescently-labelled antibodies. IgG-associated fluorescence intensity (FI) measure was automated using a fluorescence plate reader. Serum or CSF were defined as positive using a ROUT test with a FDR at 2% on quantified FI. Each CBA well was also observed by fluorescence microscopy. To cross-validate the presence of CNS-reactive antibodies, IgG reactivity was analyzed by flow cytometry using hiPSC-derived astrocytes and neurons exposed to the serum/CSF.

Results: Using our CBA, 19 patients (18 IND, 1 NIND) appeared positive on hiPSC-derived astrocytes/neurons including 5 patients previously diagnosed with auto-reactive antibodies and 14 with not-yet reported auto-reactive antibodies, results confirmed by fluorescence microscopy and flow cytometry.

Conclusion: Our hiPSC-based CBA may allow discovering new CNS-reactive antibodies. Such a potent tool opens new perspectives in establishing early diagnosis and optimizing treatments of antibody-mediated diseases of the CNS.

Disclosure: This work was supported by the Swiss National Science Foundation (320030_179531 to RDP) and the Fondation pour la médecine de Laboratoire F4LABMED (to AM). CP has received travel grants or participated to advisory boards for Merck, Biogen IDEC, Roche, Novartis, Genzyme and Celgene. RDP served on the scientific advisory board for Merck, Celgene, and Sanofi; received travel funding and/or speaker honoraria from Celgene and Roche. All other authors have nothing to declare.

EPR2196

Anti-CASPR2 clinical phenotypes correlate with HLA and immunological features

S. Muñoz Castrillo¹, B. Joubert¹, M.-H. Elsensohn², A.-L. Pinto¹, M. Saint-Martin¹, A. Vogrig¹, G. Picard¹, V. Rogemond¹, V. Dubois³, R. Tamouza⁴, D. Maucourt-Boulch⁵, J. Honnorat¹

¹Centre de Référence Nationale pour les Syndromes Neurologiques Paraneoplasiques, Hôpital Neurologique, Lyon, France, Lyons, France, ²Department of Biostatistics-bioinformatics, Hospices Civils de Lyon, Lyons, France, ³HLA Laboratory, EFS Auvergne-Rhône-Alpes, Lyons, France, ⁴Department of Psychiatry, Hôpitaux Universitaires Henri Mondor, Créteil, France, ⁵Service de biostatistiques, Hospices Civils de Lyon, Lyons, France

Background and aims: Antibodies against contactin-associated protein-like 2 (CASPR2-Ab) are associated with acquired neuromyotonia (NMT), limbic encephalitis (LE) and Morvan syndrome (MoS), but recent studies suggest a wider and overlapping spectrum. Herein, we investigated the distribution of symptoms in CASPR2-Ab patients.

Methods: A cluster analysis of neurological symptoms was performed in a retrospective cohort of 56 CASPR2-Ab patients. In parallel, we studied immunological features and HLA.

Results: Cluster analysis distinguished those with predominant limbic symptoms (n=29/56) from those with peripheral nerve hyperexcitability (PNH; n=27/56). In the limbic-prominent group, limbic features were either isolated (LE/-; 18/56, 32.1%) or combined with extra-limbic symptoms (LE/+; 11/56, 19.6%). Those with PNH had either mild PNH isolated or co-occurring with limbic symptoms (PNH/-; 11/56, 19.6%); or severe PNH accompanied by extra-limbic involvement (PNH/+; 16/56, 28.6%), resembling historical MoS descriptions. LE/- and LE/+ patients shared immunological and genetic characteristics, justifying considering them as a single entity (LE). HLA-DRB1*11:01 was carried more frequently by LE (94.0%) compared to PNH/- (40.0%, p=0.048) and PNH/+ (0.0%, p=0.003) patients. CASPR2-Ab positivity in CSF was more frequent in LE (93.1%) than in PNH/- (57.1%, p=0.04) and PNH/+ (0.0%, p=3.4x10⁻⁸) patients. CASPR2-Ab serum values were higher in LE (median 1:40960, range 1:10240-1:81920) than in PNH/- (1:160, 1:20-1:40960; p=0.002) and PNH/+ (1:3840, 1:40-1:20480; p=1.5x10⁻⁵) patients. Only PNH/+ patients had malignant thymoma (87.5%, p=4.1x10⁻¹⁰), serum LGI1-Ab (66.7%, p=2x10⁻⁶), and myasthenia gravis (50.0%, p=3.4x10⁻⁵).

Conclusion: Clinical, immunological, and genetic characteristics of CASPR2-Ab patients support the existence of 3 major disorders (LE, NMT, and MoS), suggesting distinct etiopathogeneses.

Disclosure: This study is supported by research grants from ANR (ANR-14-CE15-0001-MECANO) and FRM (Fondation pour la recherche médicale) DQ20170336751. This work has been developed within the BETPSY project,

which is supported by a public grant overseen by the French National Research Agency (ANR), as part of the second “Investissements d’Avenir” program (reference ANR-18-RHUS-0012). SM-C is supported by a research grant from Fundación Alfonso Martín Escudero (Spain).

EPR2197

Secondary autoimmune diseases and side effects in patients with Multiple Sclerosis treated with autologous hematopoietic stem cell transplantation.

E. Sbragia¹, G. Boffa¹, E. Capello², A.M. Raiola³, R. Varaldo⁴, F. Gualandi³, G.L. Mancardi¹, M. Inglese⁵

¹Department of Neuroscience, Rehabilitation, Ophthalmology, Genetics, Maternal and Child Health (DiNOGMI), University of Genoa, Italy, Genoa, Italy,

²Department of Neurology, IRCCS Ospedale Policlinico San Martino, Genoa, Italy, ³UOC Ematologia e Trapianto di Midollo Osseo, IRCCS Ospedale Policlinico San Martino, Genoa, Italy, ⁴UOC Ematologia e Trapianto di Midollo Osseo, IRCCS Ospedale Policlinico San Martino, Genoa, Italy, ⁵Department of Neurosciences, Rehabilitation, Ophthalmology, Genetics, Maternal and Child Health (DINO GMI), University of Genoa and IRCCS Policlinico San Martino, Genoa, Genoa, Italy

Background: Autologous hematopoietic stem cell transplantation (aHSCT), an immune reconstitution therapy (IRT), has been largely investigated as effective therapeutic approach for aggressive Multiple Sclerosis (MS). IRTs for MS have shown potential side effects, like secondary autoimmune diseases (SAD). Few post-aHSCT data regarding both clinical and subclinical autoimmunity with isolated laboratoristic support are known.

Aims: To describe the occurrence of both clinical and subclinical SADs in a cohort of MS patients treated with intense immunosuppression followed by aHSCT.

Methods: We evaluated 15 patients (14 relapsing-remitting MS, 1 active progressive MS) treated in our Center with aHSCT from 2016 to 2019. All patients underwent the same conditioning protocol (carmustine-cytarabine-etoposide-melphalan -BEAM- plus anti-thymocyte-globulin -ATG-), besides 1 that received high-dosage cyclophosphamide. We collected clinical-radiological data together with blood samples for SADs and lymphocitary immunophenotype at baseline and after every year.

Results: We obtained preliminary data from 5 patients. Medium follow-up was 2 years (range 1-3). No clinical SADs were evidenced. 4 patients showed laboratoristic SADs: 1 anti-smooth-muscle antibody without hepatic anomalies and 1 anti-nuclear antibody (1:320), both after 1 year and with no anomalies at immunophenotype, and 1 high titer β 2-glycoprotein-I IgM (136ru/mL) after 2 years associated with a persistent increase in B-cell percentage at immunophenotype (30-50% of lymphocyte). Ultimately, this patient showed a clinical-radiological relapse causing the start of ocrelizumab; β 2-glycoprotein-I IgM were negative at subsequent controls.

Conclusion: Isolated subclinical positivity with no clinical significance can occur in MS after aHSCT; longer follow-up is needed to better understand the significance of SADs.

Disclosure: Dr. E. Sbragia, Dr. G. Boffa, Dr. E. Capello, Dr. A.M. Raiola, Dr. R. Varaldo and Dr. F. Gualandi have nothing to disclose. Dr. G.L. Mancardi received support

from Biogen Idec (honoraria for lecturing, travel expenses for attending meetings and financial support for research), Genzyme (honorarium for lecturing), Merck Serono, Novartis, Teva (financial support for research) and Sanofi Aventis (honorarium for speaking). Dr. M. Inglese received grants NIH, NMSS, FISM; received fees for consultation from Roche, Genzyme, Merck, Biogen and Novartis.

EPR2198

FEAM: A Novel Modulator for Neuroinflammation

E. Shavit-Stein, V. Golderman, M. Ben Shimon, N. Maggio, J. Chapman
Neurology, Sheba Medical Center, Ramat Gan, Israel

Background and aims: Neural inflammation is regulated by coagulation proteins including activated protein C (aPC) and its endothelial protein c receptor (EPCR) which together activate protease activated receptor 1 (PAR1) inducing anti-inflammatory effects. We have synthesized a novel molecule based on the binding site of FVII/aPC to EPCR (FEAM) and studied its effectiveness in the treatment of neuroinflammation.

Methods: An in-vitro model for neuroinflammation was induced by LPS applied to N9 microglia cells. In-vivo neuroinflammation was induced by LPS systemic injection to ICR mice and behavior was assessed by the stair-case test. Thrombin and aPC activity from cells and brains were measured by enzymatic fluorescence assays. Proliferation was measured by XTT activity assay. Coagulation factors and inflammation markers levels were evaluated by western blot and real-time PCR.

Results: FEAM prevented the LPS induced increased proliferation rate (1 vs 1.5 arbitrary units (aU), $p < 0.001$) and PAR1 expression in N9 (1.7 vs. 1.2, $p < 0.001$). FEAM also prevented the decreased aPC activity induced by LPS (0.46 vs 0.62 aU, $p < 0.003$) and prevented the elevation of coagulation factors (FX and thrombin) and inflammatory markers (TNF α). In the whole animal model FEAM prevented the LPS induced elevated brain thrombin activity and other coagulation and inflammation factors. FEAM treatment induced improvement in general health indices such as weight, learning and memory and mobility.

Conclusion: In conclusion, FEAM modulation of the FVII-aPC-EPCR pathway may shift the thrombin/PAR1 pathway toward aPC-EPCR mediated protective downstream effects.

Disclosure: ESS JC and NM have a provisional patent "Novel Molecules for the Treatment of Inflammation". FEAM is included in this patent application. This project was supported by the Israel Innovation Authority.

EPR2199

Screening for encephalitis-causing autoantibodies in serum and CSF of first-episode psychosis patients and controls

J. Theorell¹, M. Ramberger¹, R. Harrison¹, V. Mgbachi¹, L. Jacobson¹, P. Waters¹, S. Cervenka², S.R. Irani¹, F. Piehl³

¹*Oxford Autoimmune Neurology Group, Nuffield Department of Clinical Neurosciences, University of Oxford, Oxford, United Kingdom,* ²*Centre for Psychiatry Research, Department of Clinical Neuroscience, Karolinska Institutet, Stockholm, Sweden,* ³*Department of Clinical Neuroscience, Karolinska Institutet, Stockholm, Sweden*

Background and aims: Recently, encephalitides caused by autoantibodies directed against neuronal surface proteins have been identified. Psychiatric symptoms dominate early stages of the disease progression, especially in patients with N-methyl-D-Aspartate receptor (NMDA-R) autoantibody encephalitis. Thus, a compelling hypothesis is that a subgroup of psychiatric patients might suffer from autoimmune encephalitides with atypical presentations. Previous studies addressing this hypothesis have reached divergent conclusions, possibly due to serum-only testing and/or testing of psychiatric cohorts years after disease onset.

The aim of this study is to address the hypothesis by autoantibody screening of serum and CSF from patients with first-episode psychosis and healthy controls.

Methods: Serum and CSF were collected from 77 patients presenting with first-episode psychosis, of which around half were naïve to antipsychotic drugs, and 53 control subjects. Reactivity against neuronal specific autoantigens was tested on live HEK293 cells that were transiently induced to express the dopamine receptor 2 (D2R), leucine rich glioma inactivated 1 (LGI1), Gamma Aminobutyric acid Receptors A (GABAA-R), GABAB-R, the glycine receptor, NMDA-R or Contactin associated protein 2 (CASPR2).

Results: All participants were negative in the CSF for NMDA-R autoantibodies. Furthermore, all were seronegative for antibodies to D2R, LGI1, GABAA-R, GABAB-R and the glycine receptor. 1 participant was seropositive for CASPR2 autoantibodies and 1 for glycine receptor autoantibodies, but both were autoantibody-negative in CSF.

Conclusion: No participants fulfilled diagnostic criteria for any autoimmune encephalitis. This study does not support the hypothesis that a subgroup of patients who present with psychosis have an underlying autoimmune encephalitis.

Disclosure: Jakob Theorell's work was funded by the Swedish Wenner-Gren Foundations. No other specific funding was allocated to this project.

EPR2200

Spectrum and treatment of central nervous system complications of immune checkpoint inhibitors

A. Vogrig¹, S. Muñiz Castrillo¹, B. Joubert¹, G. Picard¹, V. Rogemond¹, C. Marchal², A. M. Chiappa³, E. Chanson⁴, F. Skowron⁵, A. Leblanc⁶, F. Ducray¹, J. Honnorat¹

¹Centre de Référence des Syndromes Neurologiques Paranéoplasiques et des Encéphalites Autoimmunes, CHU de Lyon, Lyons, France, ²CHU Bordeaux, Bordeaux, France, ³CH de Cornouaille, Quimper, France, ⁴CHU Gabriel-Montpied, Clermont-Ferrand, France, ⁵CH Valence, Valencia, France, ⁶CHRU Cavale-Blanche, Brest, France

Background and aims: To describe the spectrum, treatment and outcome of central nervous system complications associated with immune checkpoint inhibitors (CNS-ICI).

Methods: Five-years retrospective nationwide study.

Results: We identified 19 patients with immune-related CNS-ICI. The patients were receiving nivolumab (n=8), pembrolizumab (n=6), a combination of ipilimumab-nivolumab (n=3), ipilimumab-durvalumab (n=1), or atezolizumab (n=1). Underlying malignancies included non-small-cell lung cancer (n=8), melanoma (n=3), bladder (n=2), kidney (n=2), pleural mesothelioma (n=1), small-cell lung cancer (n=1), liposarcoma (n=1), and Hodgkin's lymphoma (n=1). 6 of the patients developed CNS-ICI complications while having known brain metastases. Neurological phenotypes were limbic encephalitis (n=8), meningo-encephalitis (n=4), cerebellitis (n=4), and atypical syndromes (n=3; steroid-responsive isolated confusion in 2 and polyradiculoneuritis associated with subacute parkinsonism in 1). Associated autoantibodies included onconeural (Ma2 [n=7], Hu [n=1]), astrocytic cytoplasmic (GFAP [n=2]), and neuronal surface (CASPR2 [n=1]) specificities. ICIs were withheld and corticosteroid treatment was given in all cases. Additionally, 5 patients received intravenous immunoglobulin, 2 rituximab, 1 plasmapheresis, and 1 infliximab. Overall, 6 patients died (4 of them belonging to the limbic encephalitis group, all harboring Ma2 antibodies, 1 with GFAP-associated meningoencephalitis, 1 atypical seronegative). Re-administration of ICI after CNS complications was attempted in 3 patients (none of whom with limbic encephalitis), without further relapses.

Conclusion: 4 major clinical phenotypes characterize CNS complications of ICIs, each with a distinct immunological background, disease course, and response to treatment. CNS-ICI can develop in patients with known brain metastases. Intriguingly, underlying cancers, antibody prevalence and outcome appear different to those of patients with ICI-induced peripheral neurological manifestations.

Disclosure: This study is supported by research grants from ANR (ANR-14-CE15-0001-MECANO), and FRM (Fondation pour la recherche médicale) DQ20170336751. This work has been developed within the BETPSY project, which is supported by a public grant overseen by the French National Research Agency (ANR), as part of the second "Investissements d'Avenir" program (reference ANR-18-RHUS-0012).

Neuro-oncology 1

EPR2201

Diffuse leptomeningeal glioneuronal tumors: a case-series of three adult patients

C.A. Birzu¹, L. Nguyen Them², F. Bielle¹,
F. Laigle-Donadey¹

¹GH Pitié-Salpêtrière Charles Foix, Paris, France,

²Neurologie, Centre Hospitalier Perpignan, Perpignan, France

Background and aims: Diffuse leptomeningeal glioneuronal tumor (DLGNT) represents a rare entity, firstly described in 2016 WHO updated classification. Molecular hallmarks are 1p loss and a frequent MAPK pathway activation. Adult cases are exceptional.

Methods: We retrospectively reviewed 3 adult cases with histologically proven DLGNT treated in our department between 2015 and 2019.

Results: It was 1 female and 2 males, aged 29, 32 and 56 years. Initial symptoms were lumbosciatalgia, intracranial hypertension, neurocognitive impairment and Parinaud syndrome. Delay before diagnosis varied from 6 months to 8 years. At diagnosis, all patients presented with diffuse infiltration of meninges with parenchymal localizations in 2 cases. 1 of them presented a cerebral vasculitis-like aspect. Lumbar puncture was inconclusive and diagnosis confirmed after open arachnoid/intraventricular biopsy. DLGNT molecular criteria were fulfilled in 2 patients whereas the 3rd was only histological due to lack of sample. Treatment was heterogeneous including chemo and radiotherapy with different efficacy. Noteworthy is the clinical and partial radiologic response to Carboplatin used in 2 cases. 2 patients died after 24 and 40 months (1 is still alive at 96 months).

Conclusion: As the DLGNT is a rare and heterogeneous entity, diagnosis is difficult especially in adults. In most cases, meningeal biopsy with extensive molecular biology is required for diagnosis and treatment.

Disclosure: Nothing to disclose

EPR2202

Multiparametric assessment of factors influencing 2 HG accumulation in diffuse brain gliomas

A.L. Di Stefano¹, L. Nichelli², R. Valabrègue³,
L. Capelle⁴, C. Ottolenghi⁵, F. Bielle⁶, J. Lerond⁷,
M. Giry⁸, G. Berzero⁹, C. Villa¹, D. Galanaud¹⁰,
S. Lehericy¹¹, M. Marianska¹², F. Branzoli¹³, M. Sanson¹⁴

¹Hopital Foch, Suresnes, France, ²Cenir, Institut du Cerveau et de la Moelle Epinière- ICM, Paris, France, ³Institut du Cerveau et de la Moelle épinière- ICM, Centre de

NeuroImagerie de Recherche-CENIR, ICM, Paris, France, ⁴Neurosurgery, Pitié Salpêtrière Hospital, Paris, France,

⁵Service de Biochimie Métabolique, Hôpital Necker and Université Paris Descartes, Paris, France, ⁶GHPS, Paris,

France, ⁷Experimental Neurooncology, Institut du Cerveau et de la Moelle Epinière- ICM, Paris, France, ⁸Sorbonne

Universités UPMC Univ Paris 06, INSERM CNRS, U1127, UMR 7225, ICM, Paris, France, ⁹Service de Neurologie

2-Mazarin, APHP Pitié-Salpêtrière, Paris, France,

¹⁰Neuroradiologie, GH Pitié-Salpêtrière, Paris, France,

¹¹Pitié-Salpêtrière Hospital, Centre de Recherche de l'Institut du Cerveau et de la Moelle épinière, INSERM UMRS_1127,

Paris France; Pitié-Salpêtrière Hospital, Centre de

Neuroimagerie de Recherche, Paris, France, ¹²Radiology,

University of Minnesota, Minneapolis, USA, ¹³Institut du

Cerveau et de la Moelle épinière, ICM, Pitié-Salpêtrière

Hospital, Sorbonne Universités, UPMC Paris, Inserm UMR

S 1127, CNRS UMR 7225, Paris, France, ¹⁴AP-HP, Groupe

Hospitalier Pitié-Salpêtrière, Service de Neurologie, Paris, France

Background and aims: 2HG can be detected non-invasively in IDH-mutant gliomas by in vivo MRS. We investigated factors affecting 2HG accumulation and explored the prognostic value in IDH mutant gliomas and 2HG variations on treatment.

Methods: We prospectively scanned by MEGA-PRESS 70 glioma patients (24 before surgery and 46 IDH mutant operated glioma). CRLB cut-off was 50%. We followed up 9 IDH mutant patients during radiotherapy and chemotherapy. We analyzed radiological parameters and genetic profile. 2HG concentrations in plasma, urine, and surgical samples were measured by GC-MS.

Results: We detected 2HG with a sensitivity of 95% in untreated patients, and of 69% in pre-treated patient. PPV was 100% in both groups. 2HG was lower in pre-treated IDH mutant gliomas (1.1 versus 2.3mM, P=0.02) and decreased during radiotherapy and chemotherapy before any radiological change. 2HG was correlated with tumor volume (P=0.02), choline (r=0.58 P<0.0001), cellular density (r=-0.40 P=0.01), “expansive” presentation, mutant reads, urine 2HG (r=0.80, P=0.003) and inversely correlated with Myo (r=-0.29 P=0.03) and cystic areas (P=0.04). 2HG was higher in IDH2 mutant (4.7 versus 2.4mM, P=0.02) and lower in non R132H IDH1 mutant (1.12mM P=0.004). 2HG detection was associated with longer survival (HR 0.09; 95%CI 0.018-0.52).

Conclusion: Tumor volume, cellular density, previous radio- and chemotherapy and genetic features determine 2HG detection in IDH mutant gliomas. 2HG detection is associated with better outcome and can be reliably monitored during anti-cancer treatments.

Disclosure: Nothing to disclose

EPR2203

Isolated CNS involvement revealing histiocytosis with emperipolesis and BRAF mutation

J. Dufour¹, B. Mathon², M. Touat¹, K. Hoang-Xuan¹, K. Mokhtari³, A. Idbaih¹

¹Neurology, La pitié salpêtrière hospital, Paris, France,

²Neurosurgery, La Pitié-Salpêtrière Hospital, Paris, France,

³Neuro-Pathology, La pitié salpêtrière hospital, Paris, France

Background and aims: Histiocytoses are rare inflammatory myeloid hemopathies with exceptional isolated CNS involvement is exceptional. This case report aims to contribute to our understanding of this entity.

Methods: Retrospective chart review of clinical data, magnetic resonance imaging, biology and histopathological findings of a patient who presented with an atypical neurohistiocytosis with isolated CNS involvement.

Results: 48-year-old man with a history of pleural tuberculosis who presented in July 2019 with paresthesias of the left hemiface. The physical examination revealed a left 5th cranial nerve involvement. Brain MRI showed 3 FLAIR hyperintensities with homogeneous enhancement in the left temporal, occipital and cerebellar peduncle (Figure 1). Brain MRI with perfusion and spectroscopy sequences showed an increased Choline/NAA ratio without hyperperfusion (Figure 2). Blood tests and lumbar puncture were normal. Body CT-Scan and PET-CT did not evidence any systemic lesion. Several hypotheses were discussed: infectious (e.g. tuberculosis), inflammatory (neurosarcoidosis, Behcet's disease) and tumoral (lymphoma). A stereotaxic brain biopsy was rapidly performed. Histological analysis showed parenchymal infiltration with foamy histiocytes. Immunostaining revealed CD68+, CD163+, PS100+, and CD1a- tumor cells and tumor sequencing detected a BRAF(V600E) mutation, overall consistent with Erdheim Chester disease (ECD), BRAF-mutant. However, emperipolesis lesions (Figure 3) - suggestive of Destombes-Rosai-Dorfman disease (RDD) - were also present, suggesting a possible mixed form, never reported to our knowledge.

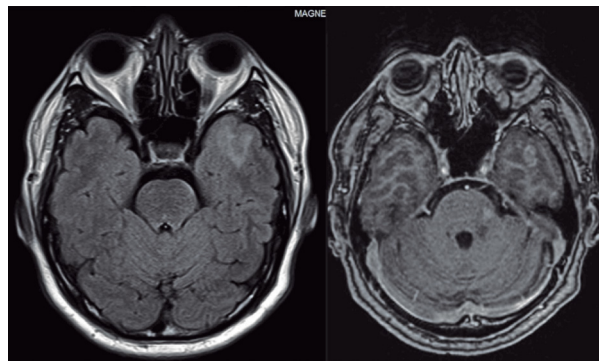

Figure 1

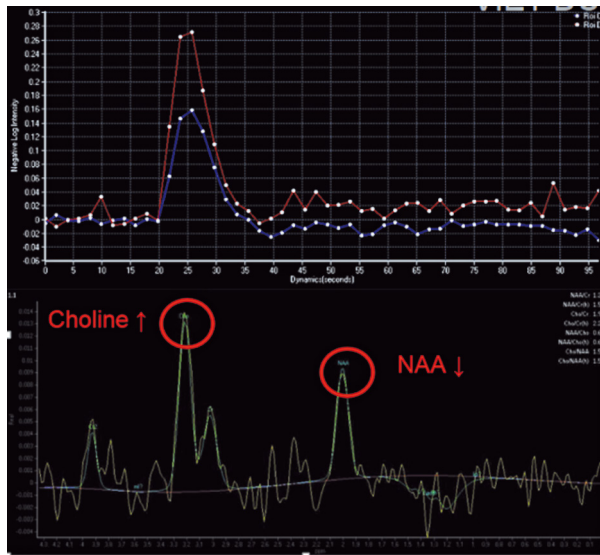

Figure 2

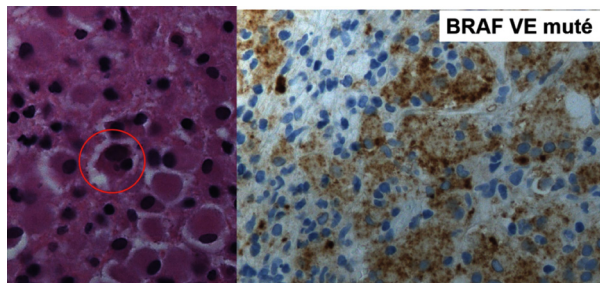

Figure 3

Conclusion: This report expands the spectrum of neurohistiocytosis and raises the question of mixed forms characterized by the presence of both emperipolesis and BRAF mutation.

Disclosure: Nothing to disclose

EPR2204

Initial temozolomide for high-risk low-grade gliomas in a phase II AINO (Italian Association for Neuro-Oncology) study: a post-hoc analysis of the efficacy within molecular subgroups of WHO 2016

F. Franchino¹, A. Pellerino¹, F. Bruno¹, L. Bertero², R. Soffietti¹, R. Rudà¹

¹Division of Neuro-Oncology, Department of Neuroscience, University and City of Health and Science Hospital of Turin, Turin, Italy, ²Medical Sciences, Pathology Unit, University and City of Health and Science Hospital, Turin, Turin, Italy

Background and aims: Regarding the optimal treatment strategy for high risk WHO grade II gliomas after incomplete surgery the efficacy of adjuvant chemotherapy to delay radiotherapy and the risk of cognitive defects is still debated.

Methods: A re-evaluation, according to new molecular subgroups of WHO 2016, of long term results of up-front temozolomide for a cohort of high risk grade II gliomas included in a phase II multicenter study (60 patients) has been performed. The primary endpoint was response according to RANO criteria, while secondary endpoints were seizure response, PFS and OS.

Results: Response rate was significantly higher among oligodendrogliomas IDH-mutant and 1p/19q codeleted (76%) than among diffuse astrocytomas either mutant (55%) or wild-type (36%). A reduction of seizure frequency >50% was observed in 87% of patients and a seizure freedom in 72% with a significant association of seizures reduction >50% with the presence of an IDH mutation. Median PFS, PFS at 5 and 10 years, median OS and OS at 5 and 10 years were significantly longer in oligodendrogliomas IDH-mutant and 1p/19q codeleted. In a median follow-up of 9.3 years 67% of patients with oligodendroglioma IDH mutant and 1p/19q codeleted did not recur and 59% did not receive radiotherapy at recurrence with a median follow-up of 8.2 years.

Conclusion: The use of temozolomide as initial treatment is an useful option for oligodendrogliomas IDH-mutant and 1p/19q codeleted, when incompletely resected or progressive after surgery alone, or with intractable seizures. Radiotherapy and/or reoperation and/or second-line chemotherapy, at recurrence, could be useful.

Disclosure: Nothing to disclose

EPR2205

Undiagnosed Lymphomatosis Cerebri progression to space-occupying lesion.

J. Gómez Corral¹, J. Buisan¹, N. Garcia-Barragan¹,
A. Celdrán de Castro García¹, B. Baena Álvarez¹,
R. Sainz-Amo¹, C. Vior²

¹Neurology, Hospital Universitario Ramon y Cajal, Madrid, Spain, ²Neurosurgery, Hospital Universitario Ramón y Cajal, Madrid, Spain

Background and aims: Lymphomatosis cerebri (LC) is a rare variant of Primary Central Nervous System Lymphoma (PCNSL) in which neuroimaging shows diffuse instead of nodular white-matter distribution.

Methods: A 72-years-old male with medical history of IV right cranial nerve microvascular paresis and bladder carcinoma in remission presented subacute dementia and focal seizures. CT and MRI showed a cortical and white-matter diffuse bifrontal lesion with little, irregular contrast enhancement. CSF analysis ruled out infections. Steroids and antiepileptics were empirically started due to suspicion of gliomatosis cerebri with oedem. Steroids were prescribed for 10 days with posterior tapered schedule. The biopsy 9 days after was inconclusive. Body PET-CT showed no alterations. The patient recovered his previous cognitive level and remained without seizures on lacosamide. 1 year later the patient presented subacute right cerebellar syndrome and forgetfulness.

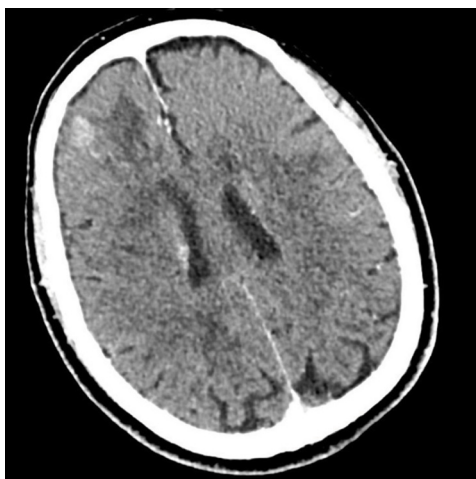

Figure 1: Cranial CT with contrast at admission (before steroid initiation). Bilateral leukopathy especially prominent on right frontal lobe with cortical thickening and associated mild, patchy contrast enhancement.

Results: A new MRI disclosed a homogenous enhancing right cerebellous mass and progression of leukopathy. The cerebellar mass was biopsied. Immunohistochemistry was positive for Diffuse Large B-cell Lymphoma (DLBCL). The patient is currently under induction treatment with high-dose methotrexate and steroids with neurological improvement.

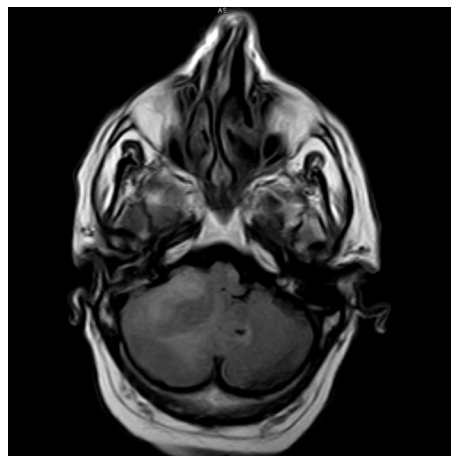

Figure 2: MRI T1-weighted with Gadolinium enhancement. A new onset cerebellar space occupying lesion with homogeneous contrast enhancement and mass-effect compatible with cerebellar lymphoma.

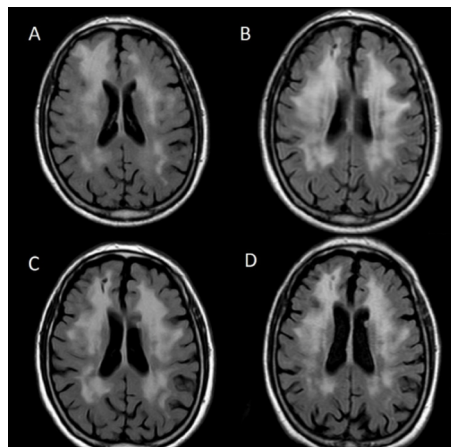

Figure 3: White matter involvement evolution in FLAIR sequences. A-Nov 2018. Asymmetrical leukopathy with marked right frontal lobe involvement. B-Feb 2019. After 50 days of steroid treatment showing decrease in right frontal lobe involvement and a more symmetrical white matter distribution. C and D: Jun 2019 and Dec 2019, respectively.

Conclusion: Leukopathy-like lesions have been described as “sentinel lesions” for PCNSL. Polyclonal B-cell proliferations evolving into monoclonal tumours have been hypothesized. Conversely, an early response to steroid treatment may have obscured initial tests results. The early and transient clinical and radiological response to steroids is consistent with a LC debut of a PCNSL. We highlight the importance of LC in the differential diagnosis of leukopathy and steroid-induced changes in this pathology.

Disclosure: Nothing to disclose

EPR2206

Clinical and Molecular Prognostic Factors for Long-Term vs Short-term Survival of Patients with Glioblastomas

A. Laurence, K. Mokhtari, L. Capelle, M. Sanson
Groupe hospitalier Pitié-Salpêtrière, Paris, France

Background and aims: This study aims to clarify the clinical and molecular characteristics associated with long- or short-term survival in glioblastoma, which remain until now largely unknown.

Methods: We analyzed clinical and molecular characteristics of 74 long-term survivors (>5 years, LTS) and 376 short-term survivors (<1 year, STS) from the Parisian tumor database.

Results: Age at diagnosis ($p < 10^{-11}$), KPS (Karnofsky Performance Score) at diagnosis ($p < 10^{-7}$) and type of surgery (biopsy vs resection, $p < 10^{-9}$) differed according to the long or short survival. The IDH (Isocitrate DeHydrogenase) mutation rate was higher in LTS than STS (29% vs 8.3%, $p < 0.0004$), as well as the promoter methylation of the MGMT gene (O6-methylguanine-DNA methyltransferase) (88% vs 46%, $p < 0.004$), the gain of chromosome 19p (42% vs 22%, $p < 0.03$), and of 19q (32% vs 17%, $p < 0.05$). After adjustment for age at diagnosis, complete loss of chromosome 10 ($p < 0.004$), loss of 10q or 10p ($p < 0.02$ and 0.03) were additionally significantly more frequent in LTS. In the subgroup with IDH wild-type (IDHwt), complete loss of 10 ($p < 0.006$), loss of 10q and 10p ($p < 0.02$ and 0.03), promoter methylation of MGMT ($p < 0.02$) and mutation of P53, $p < 0.05$) were significantly more frequent in LTS after adjustment for age.

Conclusion: Younger age and better KPS at diagnosis are associated with LTS vs STS, as well as resection vs biopsy. MGMT promoter methylation, loss of chromosome 10 and gain of 19p or 19q might be prognostic for longer survival, as well as P53 mutation for IDHwt patients.

Disclosure: Nothing to disclose

EPR2207

Long-term follow-up of schwannoma growth behavior in adult neurofibromatosis type 2 and schwannomatosis patients using whole-body MRI

I. Ly¹, R. Thalheimer¹, W. Cai¹, M. Bredella¹, A. Muzikansky¹, V. Merker², H. Herr¹, J. Da¹, G. Harris¹, S. Plotkin¹, J. Jordan¹

¹Massachusetts General Hospital, Boston, USA, ²Edith Nourse Rogers Memorial Veterans Hospital, Bedford, USA

Background and aims: Neurofibromatosis type 2 (NF2) and schwannomatosis (SWN) are related genetic tumor predisposition syndromes caused by distinct gene mutations on chromosome 22, and are characterized by the presence of cranial, peripheral, and/or spinal nerve schwannomas. The long-term growth behavior of schwannomas is unknown but knowledge thereof would help guide patient surveillance and selection for treatment. Whole-body MRI (WBMRI) can detect whole-body schwannoma burden.

Methods: 12 NF2 and 10 SWN patients who underwent WBMRI between 2007-2010 underwent repeat WBMRI between 2018-2019. Schwannomas were segmented on short tau inversion recovery (STIR) sequences. Tumor volume was calculated using a 3-dimensional tumor quantification software (3DQ1). Tumor growth and shrinkage were defined as a volume change $\geq 20\%$ over the entire study period.

Results: Median time between scans was 10 years. 103 schwannomas were analysed (Table 1). 50% of tumors grew by a median 88.3% (NF2-associated) and 100.4% (SWN-associated); all growing NF2-associated schwannomas grew in the setting of exposure to systemic therapy. Excluding resected tumors, 19.4% of tumors shrank by a median 48.5% (NF2-associated) and 37.4% (SWN-associated). All shrinking NF2-associated tumors had been treated with systemic therapy whereas none of the shrinking SWN-associated tumors had been. 19 new tumors developed in 8 patients.

	NF2-associated schwannomas	SWN-associated schwannomas
Number of tumors analysed	46	57
Median % change in tumor volume	+9.4%	+6.1%
Number of growing tumors (%)	23 (50.0%)	29 (50.1%)
• Median growth (%)	• +88.3%	• +100.4%
• Number of tumors treated with systemic therapy (%)	• 23 (100%)	• 1 (3.4%)
Number of shrinking tumors (%)	10 (21.7%)	10 (17.5%)
• Median shrinkage (%)	• -48.5%	• -37.4%
• Number of tumors treated with systemic therapy (%)	• 10 (100%)	• 0 (0%)
Number of new tumors (%)	7 (15.2%)	12 (21.1%)

Table 1. Comparison of schwannoma growth behavior in NF2 and schwannomatosis patients

Conclusion: Half of NF2- and SWN-associated schwannomas grow significantly over a decade. In NF2 patients, growth occurs despite systemic treatment whereas, in SWN patients, schwannomas may shrink spontaneously without treatment. These findings suggest a more aggressive tumor phenotype in NF2 patients. Patient enrollment and correlation of MRI findings with functional outcomes and hormone exposure history are ongoing.

Disclosure: This research was supported by philanthropic funds to Drs. Scott Plotkin and Justin Jordan.

EPR2208

Clinical and imaging characterization of Dysembryoplastic Neuroepithelial Tumours: an experience of a tertiary hospital in Portugal

M. Machado¹, D. Silva¹, S. Grenho Rodrigues¹, R.V.F.R. Roque¹, J. Pimentel²

¹Lisbon, Portugal, ²Laboratory of Neuropathology (department of Neurology), Hospital de Santa Maria do Centro Hospitalar de Lisboa Norte, Lisbon, Portugal

Background and aims: Dysembryoplastic neuroepithelial tumours (DNET) are benign, slow-growing tumours usually presenting with intractable seizure, due to its mainly cortical topography and associated with a good prognosis following tumour resection. We aim to characterize the clinical and imaging features of a case series from a tertiary hospital in Portugal.

Methods: A retrospective study of DNET diagnosed at the laboratory of neuropathology between 2000 and 2019. Clinical and imaging data were collected from the clinical files. Histological samples were reviewed by 2 neuropathologists.

Results: 23 patients with DNET were included, 13 males, with a mean age of 24.61 years [4 to 55]. In some patients clinical data is missing. Tumour localization was mostly in the temporal lobe (52.2%), and 1 patient presented an intraventricular DNET. 19 of 21 patients (95%) presented with epilepsy, 63% of these being refractory to medication. 1 patient presented with headaches and for 1 was an incidental finding on image. 1 patient had associated cortical dysplasia. There were no tumour recurrences. Almost (14 out of 16) all of the epileptic patients were seizure-free and in 5 patients antiepileptic drugs were stopped.

Conclusion: Our study is in accordance with the literature regarding clinical presentation, location and post-surgical outcome. Indeed, patients had no tumour recurrences and most became seizure-free, some of them with antiepileptic drugs suspension.

Disclosure: Nothing to disclose

EPR2209

CXCL13 and CXCL9 as diagnostic and therapy monitoring markers in central nervous system lymphoma

I. Masouris¹, M. Pfirrmann², K. Manz², U. Ködel¹, L. Von Baumgarten¹

¹Department of Neurology, Ludwig Maximilians University Munich, Munich, Germany, ²Institute for Medical Information Processing, Biometry, and Epidemiology, Faculty of Medicine, Ludwig Maximilians University Munich, Munich, Germany

Background and aims: CNS lymphoma (CNSL) is an aggressive brain tumour with poor prognosis when untreated. Standard diagnostics like MRI and cerebrospinal fluid (CSF) analysis are often not sensitive/specific enough so that invasive biopsy must be performed to confirm diagnosis. This illustrates the need for less invasive biomarkers with high diagnostic yield, particularly in the CSF.

Methods: In this prospective monocentric study, we explored the potential of CXCL13 and CXCL9 as diagnostic, therapeutic and prognostic biomarkers for CNSL. For that purpose, CSF and serum samples were collected from patients presenting with brain lesion(s), in whom diagnostic lumbar puncture was performed during clinical routine. Samples were obtained from patients at different disease stages (first admission, remission, relapse, progress). CXCL13 and CXCL9 concentrations were determined by commercially available ELISA kits.

Results: CSF CXCL13 and CXCL9 levels were significantly increased in patients with CNSL compared to those with lesions of other origin. A cut-off value of 80pg/ml for CXCL13 shows high sensitivity (90.7%) and specificity (90.1%) for the diagnosis of CNSL. CXCL9 at a cut-off value of 84pg/ml is less sensitive (61.5%) and specific (87.1%). The combined elevation of both proteins reached a specificity of 98% at the expense of a low sensitivity (58,5%). Both cytokines correlate with clinical course and therapeutic response; their concentrations decrease upon remission and increase again during CNSL relapse.

Conclusion: Our results suggest CSF CXCL13 and CXCL9 as promising biomarkers for diagnosis and therapy monitoring in CNSL. However, our findings need further validation in independent cohorts.

Disclosure: Nothing to disclose

Neurorehabilitation

EPR2210

French survey about pain perception and management in patients with locked-in syndrome: Preliminary results.

E.A. Bonin¹, S. Blandiaux¹, V. Blandin², A. Wolff³,
A. Thibaut³, M.-E. Faymonville⁴, S. Laureys³,
O. Gosseries³, A. Vanhauzenhuys³

¹GIGA Consciousness, Université de Liège, Liège, Belgium,
²ALIS - Association du Locked-In Syndrome, Boulogne-
Billancourt, France, ³Liège, Belgium, ⁴Service d'Algologie,
Centre Hospitalier Universitaire, Liège, Belgium

Background and aims: Patients with locked-in syndrome (LIS) may suffer from chronic pain, which can significantly affect their daily life and well-being. In this survey, we aim to investigate the presence of potential pain and how it is managed in patients with LIS.

Methods: An online survey was completed by patients with LIS through the Association du Locked-In Syndrome (ALIS) and the Centre du Cerveau2 networks. It was divided in 2 sections: a 1st part collecting respondents' socio-demographic information (gender, age, etiology), and a 2nd part collecting data on pain perception and management (type and frequency of pain, daily pain impact, tested treatments).

Results: Among the 58 respondents (20 females, mean age 49±13 yo, 35 strokes), 26 experienced pain in their daily life (45%; median pain intensity: 6.5/10; 54% with leg pain) and 22 of them had punctual pain (85%, presents at certain times of the day). Out of these 26 patients, 19 (73%) received pain treatment (61% pharmacological, 11.5% non-pharmacological such as osteopathy and acupuncture) and judged the treatment efficacy as being moderate (median treatment efficiency: 5 – range 0-10). However, 15/26 (58%) patients are willing to try other non-pharmacological treatments such as hypnosis or meditation. Furthermore, they declared that pain influences their sleep quality (42%), emotions (85%) and attention (58%).

Conclusion: Almost half of the LIS patients experience pain that affect their quality of life, sleep and cognition. Current pharmacological and non-pharmacological treatments are perceived as moderately efficient and more than half of the patients would like to try new non-pharmacological treatments.

Disclosure: This study was supported by the University and University Hospital of Liège, the Belgian National Funds for Scientific Research (F.R.S-FNRS), the European Union's Horizon 2020 Framework Program for Research and Innovation under the Specific Grant Agreement No. 785907 (HBP SGA2), Luminous project (EU-H2020-fetopen-ga686764), the James McDonnell Foundation, the Public Utility Foundation 'Université Européenne du Travail', the "Fondazione Europea di Ricerca Biomedica", AstraZeneca Foundation, "Plan National Cancer" of Belgium (grant number 138), Benoit Foundation (Bruxelles), A.T. is a post-doctoral fellow, and S.L. is research director at the F.R.S-FNRS.

EPR2211

Patients with disorders of consciousness may experience pain during physiotherapy.

E.A. Bonin¹, M.L.B. Fossati², M.M. Filippini³,
S. Bornheim⁴, O. Bodart¹, S. Laureys¹, A. Thibaut¹,
C. Chatelle¹

¹Liège, Belgium, ²Behavioral and Nervous System Sciences,
University of Pavia, Pavia, Italy, ³Coma Science Group,
GIGA-Consciousness, University of Liège, Liège, Belgium,
⁴Departement of Sport and Rehabilitation Sciences,
University of Liège, Liège, Belgium

Background and aims: Neuro-orthopaedics disorders are common in patients with disorders of consciousness (DOC) and can lead to potential pain during PT (physiotherapy). These patients' inability to communicate makes pain management difficult for clinicians. In this randomized double-blind placebo-controlled study, we investigated the presence of signs of nociception during PT and following an analgesic treatment.

Methods: During baseline, the NCS-R (Nociception Coma Scale-Revised) was used to assess pain: at rest; following a tactile (TS) and a nociceptive stimulation (NS); and during PT. Patients with signs of potential pain during PT were assessed during a placebo and analgesic treatment conditions on 2 consecutive days in a randomized order. We used Kruskal-Wallis and Wilcoxon tests (post hoc analysis) to investigate difference in NCS-R scores between each condition.

Results: 15 out of 19 patients presented signs of potential pain during PT (78.9%), and only 5 of them already had an analgesic treatment before the study (5/15; 33.3%). Patients showed higher NCS-R scores during PT as compared to the three others conditions, suggesting that passive mobilizations are potentially painful for DOC patients. Out of the 19 patients enrolled, 10 were included in the placebo-controlled trial (time-window too short for treatment administration). We did not find an effect of analgesic treatment on the NCS-R score for any condition.

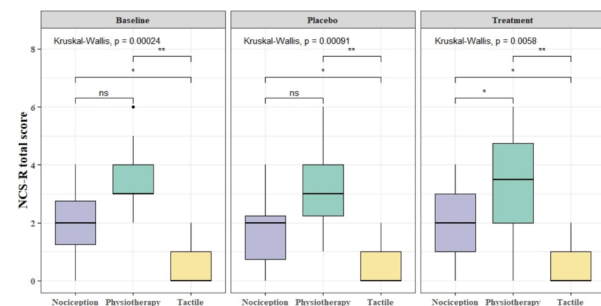

Figure 1: Change in the NCS-R total scores (tactile or nociceptive stimuli or PT), at baseline, after placebo and after treatment administration (n=10, Wilcoxon matched pairs signed rank tests as post hoc analysis, **=p<0.01, *=p<0.05)

Conclusion: This study highlights that PT may be painful for DOC patients and appropriate assessment and treatment before and during mobilizations should become a priority in clinical setting. Future studies should focus on development of sensitive assessment tools and analgesic dosage.

Disclosure: This study was supported by the University and University Hospital of Liège, the Belgian National Funds for Scientific Research (F.R.S-FNRS), the Marie Skłodowska-Curie Actions (H2020-MSCA-IF-2016-ADOC-752686), the European Union's Horizon 2020 Framework Program for Research and Innovation under the Specific Grant Agreement No. 785907 (HBP SGA2), Luminous project (EU-H2020-fetopen-ga686764), the James McDonnell Foundation, the Public Utility Foundation 'Université Européenne du Travail', the "Fondazione Europea di Ricerca Biomedica". A.T. and C.C. is a post-doctoral fellow, and S.L. is research director at the F.R.S-FNRS.

EPR2212

The effect of hypoxic-hypercapnic training on the regression of neurological deficit after a stroke (pilot study).

P. Kovzelev¹, M. Topuzova¹, A. Chaykovskaya¹, P. Tregub², A. Krasil'nikova¹, T. Alekseeva¹

¹Department of Neurology and Psychiatry, Federal State Budgetary Institution «Almazov National Medical Research Centre» of the Ministry of Health of the Russian Federation, Saint-Petersburg, Russian Federation, ²Altai Medical Institute of Postgraduate Education, Barnaul, Russian Federation

Background and aims: In our previous studies, hypoxic-hypercapnic respiratory training (GGRT) have shown efficacy in the rehabilitation of patients after ischemic stroke (IS) in the acute period.

Methods: We continued a pilot, blind, randomized, placebo-controlled study in which 40 patients participated in the acute period of mild to moderate IS. All patients were randomized to exposure group (GE) and placebo group (GP). Patients were evaluated clinically before and after the course of GGRT, or placebo exposure according to the NIHSS, Barthel, Rankin, Rivermead scales, and the Stange test was also used. The average number of training was 7.4±2.1, the time of each training was 20 minutes.

Results: Positive dynamics is noted in all groups on all used scales (p<0.05). During early rehabilitation with GGRT, a decrease in the neurological deficit estimated by NIHSS and an increase in mobility estimated by Reavermead were found: NIHSS GE 4.1±1.2 → 1.2±0.9 (p<0.01), NIHSS GP 4.2±1.7 → 2.5±2 (p<0.01), Rivermead GE 8.1±2.5 → 14.1±1.8 (p<0.01), Rivermead GP 7.4±2.5 → 12.3±1.8 (p<0.01). The degree of restoration of neurological functions in GE is significantly higher than GP (p = 0.036). A similar dynamics is also noted in the assessment by the index of mobility of GE and GP (p=0.027).

Conclusion: GGRT can be an effective and safe way to rehabilitate patients after IS.

Disclosure: Nothing to disclose

EPR2213

Withdrawn

EPR2214

Imaging Correlates of Hand Motor Performance in Multiple Sclerosis: Focus on Structural and Functional Motor Networks

C. Cordani¹, P. Valsasina¹, A. Meani¹, F. Esposito², B. Colombo², E. Pagani¹, M. Filippi¹, M.A. Rocca¹
¹Neuroimaging Research Unit, Institute of Experimental Neurology, Division of Neuroscience, IRCCS San Raffaele Scientific Institute, Milan, Italy, ²Neurology Unit, IRCCS San Raffaele Scientific Institute, Milan, Italy

Background and aims: Hand-motor impairment has a strong impact on daily-life activities in multiple sclerosis (MS) patients and MRI-metrics may contribute to better understand the substrates of these clinical deficits. We applied source-based morphometry, mean diffusivity indices and seed-based analysis, in a large cohort of MS patients to assess the association between altered MRI findings and measures of manual dexterity as well as global disability.

Methods: From 134 HC and 366 right-handed MS patients, brain 3D T1-weighted, diffusion tensor and functional (at rest) MRI scans were acquired and used to perform multivariate analyses between MRI measures of manual dexterity [9 Hole Peg Test (9HPT) and Finger Tapping (FT) test] and Expanded Disability Status Scale (EDSS).

Results: Compared with HC, MS patients showed significant atrophy in motor relevant GM networks, alteration of WM tract integrity, and abnormal resting state (RS) functional connectivity (FC) ($p < 0.001$). The multivariate analysis retained age, lower normalized brain volume (NBV), cerebellar GM network atrophy, and reduced right corticospinal tract fractional anisotropy (FA) as best predictors of EDSS score ($R^2 = 0.40$). Worse right and left 9HPT performance ($R^2 = 0.49$ for both) was predicted by progressive MS phenotype (PMS), age, male-gender, reduced NBV, higher T1 lesion load, reduced cerebellar peduncle FA, and increased left inferior frontal gyrus RS FC. FT performance predictors (right- $R^2 = 0.40$; left- $R^2 = 0.41$) were PMS, age, female-gender, sensorimotor and cerebellar network atrophy and reduced RS FC in sensorimotor regions.

Conclusion: GM tissue loss, WM-tract and RS FC abnormalities in motor-related regions contributed to explain hand-motor dysfunction in patients with MS.

Disclosure: Nothing to disclose

EPR2215

Botulinum Toxin Clinic for Neurology Patients in the Maltese Islands: Analysis of Therapeutic Use and Outcome Measures

T. Dalli¹, S. Azzopardi², M. Mallia²
¹Mater Dei Hospital, Msida, Malta, ²Department of Neuroscience, Mater Dei Hospital, Msida, Malta

Background and aims: The aim of this retrospective audit was to assess the number of patients making use of the service, the nature of the disorders being treated and further demographic data relating to number of visits, Botulinum toxin dose and time of follow-up. Modes of measurement and documentation of clinical outcomes were also assessed.

Methods: Medical records as well as an online patient register were used to gather the above data. The patients' expectations and objective treatment goals were recorded when information was available from the medical records. Input by other members of the multidisciplinary team such as physiotherapists and occupational therapists was also recorded.

Results: 86 patients have attended the Botulinum Toxin (BoNT) Clinic since its set-up in 2013. Mean patient age was 51 years. The majority of patients were referred following an ischaemic cerebrovascular event (Graph 1). Duration of treatment was influenced by the underlying diagnosis (Table 1). Documentation of clear treatment goals and patient's expectations was low (30%). 70% of cases documented symptomatic improvement, however objective assessment scales were not routinely used. Physiotherapists followed up 76% of patients.

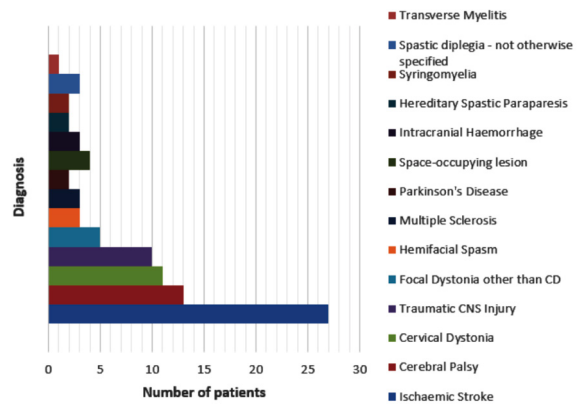

Graph 1. Diagnoses of patients treated at the Botulinum Toxin Clinic

Diagnosis	Number of patients	Botulinum toxin Dose	Average years on Treatment	Average No. of Visits	Average Interval between visits
Ischaemic Stroke	24	50-200U	1.4	4	4 months
Cerebral Palsy	11	50-150U	3	9	5 months
Cervical Dystonia	13	50-100U	5.4	14	4-5 months
Focal Dystonia other than CD	5	50-100U	< 1	2	0-3 months
Traumatic brain / spinal injury	10	100-200U	2.5	6 - 7	3-4 months
Arteriovenous malformation	1	100U	< 1	2	4 months
Intracranial Haemorrhage	3	100U	1	4	4 months
Multiple Sclerosis	3	100U	5	11	4 months
Parkinson's Disease	2	100U	< 1	2	3 months
Hemifacial Spasm	2	50U	3	3	4 months
Spastic Diplegia - not otherwise specified	3	100U	1.5	4	3-4 months
Hereditary Spastic Paraparesis	2	100-200U	3	8	4 months
Syringomyelia	2	100U	3	9	4 months

Table 1. Treatment data for different patient groups

Conclusion: Patients with a vast array of neurological conditions benefit from treatment with BoNT. In patients requiring treatment for a prolonged period, the use of clear outcome measures can help to guide treatment goals and set realistic expectations. Use of objective rating scales has now been implemented following this audit. The recent addition of physiotherapists to the BoNT clinic team has been instrumental in providing valuable input and liaison with other rehabilitation professionals.

Disclosure: Nothing to disclose

EPR2216

Overall clinical complexity of patients in prolonged Vegetative and in Minimally Conscious State: a multi-center observational study.

A. Estraneo¹, O. Masotta², F. De Bellis³, S. Abi & Doc Special Interest Group⁴

¹Neurorehabilitation, IRCCS Fondazione Don Carlo Gnocchi, Florence, Italy, ²ICS Maugeri IRCCS, Telese Terme (BN), Italy, ³Telese, Italy, ⁴Polo Specialistico Riabilitativo - Fondazione Don Gnocchi, Sant'Angelo dei Lombardi, Italy, ⁴Neurorehabilitation, Italian Society of Neurological Rehabilitation, SIRN, Rome, Italy

Background and aims: Patients in Vegetative State (VS) and in Minimally Conscious State (MCS) show a high burden of medical complications [Estraneo et al., 2018] and care needs [Whyte et al., 2013]. The present observational multi-center study aimed at comparing overall clinical complexity (OCC), including both medical complications (e.g., respiratory failure; heterotopic ossifications, HO; parasympathetic hyperactivity, PSH) and care needs (e.g., management of artificial ways for eating and breathing), in the two diagnostic groups.

Methods: Demographic, anamnestic and clinical data from 264 patients (VS=141; MCS=123; see Table 1) were collected within 1 week after admission to 23 Italian intensive neurorehabilitation units. Medical complications developed in the 1st 3 months of rehabilitation stay were also recorded. Beyond comparing the 2 diagnostic groups, we also compared OCC in patients with vascular, anoxic and traumatic etiology.

	Available Data	DoC	VS	MCS	Anoxic	Vascular	TBI
N		264	141	123	56	125	83
Meanage (SD), (years)	264	57,8 (17,7)	59,6 (16,9)	55,7 (18,3)	54,7 (16,9)	64,7 (13,3)	49,5 (19,8)*
Sex M:F (n)	264	185/79	100/41	85/38	42/14	74/51	69/14*
Etiology	264						
Anoxic		56	42	14*			
Vascular		125	57	68			
TBI		83	42	41			

Note: DoC= Disorder of Consciousness; VS = vegetative state; MCS= minimally conscious state; TBI = traumatic brain injury. *significant group-difference at p<0.05 (Fisher's exact Test, Chi-square Test or ANOVA as appropriate)

Results: Patients in VS showed significantly higher occurrence of percutaneous endoscopic gastrostomy, tracheotomy tube, pressure sores and oxygen therapy than patients in MCS. Moreover, patients in VS developed genito-urinary and respiratory complications, PSH and HO more frequently than patients in MCS. Compared with other etiological groups, post-anoxic patients had lower level of consciousness, higher functional disability and higher presence of gastrostomy, whereas traumatic patients had higher occurrence of craniectomy, HO and need for continuous clinical monitoring, and vascular patients showed more comorbidities before brain injury.

Conclusion: Both VS and MCS show very severe OCC in rehabilitation settings. Frequency of several conditions depends on clinical diagnosis and etiology. These findings could help in guiding clinical management and planning treatment.

Disclosure: Nothing to disclose

EPR2217

Brain-Computer interface (BCI) triggered functional electrical stimulation (FES) and avatar for motor rehabilitation of the lower limbs of chronic stroke patients, a group study.

F. Fernandes, C. Guger

g.tec medical engineering GmbH, Schiedlberg, Austria

Background and aims: Brain-Computer Interfaces (BCIs) show important rehabilitation effect for patients after stroke. Previous studies have shown improvement, also for patients that are in chronic stage and/or have severe hemiparesis and are particularly challenging for conventional rehabilitation techniques.

Methods: For this pilot study 5 stroke patients in chronic phase with hemiparesis in the lower extremity were recruited. All of them participated in 25 BCI sessions about 3 times a week. BCI system was based on the motor imagery of the paretic foot and healthy hand with Functional Electrical Stimulation (FES) and Avatar feedback. Assessments were conducted to assess the changes in motor improvement before, after and during the rehabilitation training.

Results: Our primary measures used for the assessment were 10-meters walk test (10MWT) and Timed "Up and Go" Test (TUG). The results show an improvement in the 10MWT of 8.54 seconds (25.5%) for all 5 patients in self-selected velocity. TUG improvement was 7.3 seconds (16% faster). 1 patient was not able to perform this test the results before the rehabilitation training due to the impermanent and difficulties in mobility, but was finally able to perform this test after the BCI sessions.

Conclusion: These outcomes show the feasibility of this BCI approach for chronic stroke patients, and further support the growing consensus that these types of tools might develop into a new paradigm for rehabilitation tool for stroke patients. However, the results are from only five chronic stroke patients, a broader randomized controlled study involving more patients is already ongoing.

Disclosure: This research is financed by g.tec medical engineering GmbH, which is selling this BCI system.

EPR2218

Effect Of High Frequency Repetitive Transcranial Magnetic Stimulation Of The Contralesional Dorsal Premotor Cortex On Recovery From Post-stroke Severe Motor Impairment

E.M. Ibrahim¹, M.A. Zaki², M.G.M. Gabr¹

¹Neurology, Al-Azhar Faculty of Medicine-Damietta Egypt, Damietta, Egypt, ²Neurology, Al-Azhar Faculty of Medicine-Cairo Egypt, Cairo, Egypt

Background and aims: The traditional inhibition of contralesional M1 (cM1) using low frequency rTMS fails to improve post-stroke severe motor impairment. While previous data suggested that cM1 exerts transcallosal inhibition on ipsilesional M1, there is recent evidence that contralesional PMd (cPMd) has compensatory roles in severely impaired patients.

Objectives: To study whether facilitating cPMd with high frequency rTMS, instead of conventionally suppressing cM1, can improve post-stroke severely impaired upper extremity or not.

Methods: Forty right-handed, first ever stroke patients (3 months post-event) with severe stroke symptoms, severe motor deficit, and radiologically evident massive infarctions at baseline were randomly assigned to two equal groups, to receive ten consecutive sessions of either high frequency rTMS on cPMd; or sham rTMS. MRC scores and UE-FMA were assessed pre- and post-intervention.

Results: One way ANCOVA revealed significant improvements in grand means of MRC in the active group in relation to the sham group ($F=56.093$, $P<0.0005$, $\eta^2=0.603$), mainly proximal MRC ($F=85.551$, $P<0.0005$, Partial $\eta^2=0.698$), whereas no significant improvement in the mean distal MRC ($F=6.380$, $P=0.016$, $\eta^2=0.147$). Similarly, UE-FMA totals were markedly improved in the active group in relation to the sham group ($F=130.331$, $P<0.0005$, $\eta^2=0.779$), mainly proximal UE-FMA ($F=169.915$, $P<0.0005$, $\eta^2=0.821$). Stepwise regression showed that lower baseline MRC of the affected UE is an independent predictor of better response to the novel rTMS approach.

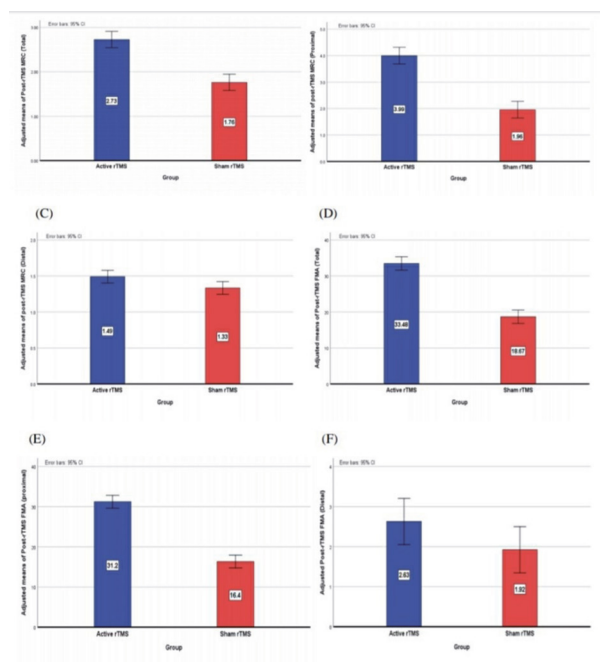

Figure 1. Comparison of adjusted mean of post-rTMS means of (A) mean distal MRC; (B) mean proximal MRC; (C) grand mean MRC; (D) distal UE-FMA; (E) proximal UE-FMA; (F) total UE-FMA of the affected side

Conclusion: Applying high frequency rTMS to cPMd improves motor functions of the disabled UE, mainly proximal, in more severely impaired stroke patients.

Disclosure: Nothing to disclose

EPR2219

Biofeedback therapy using the Anika gloves in the rehabilitation.

M. Gafurjonov¹, Y. Nabyevna², I. Nasirova², S. Nabyevna², N. Abdurashidovna²

¹Tashkent, Uzbekistan, ²Neurology, Tashkent Pediatric Medical Institute, Tashkent, Uzbekistan

Background and aims: Biofeedback therapy using the Anika computer glove in the rehabilitation of patients with impaired motor function after a stroke. To study the effectiveness of biofeedback therapy using the Anika gloves.

Methods: During the study, rehabilitation measures were carried out in 41 patients aged 45-70 years with ischemic stroke and functional disorders. In the 1st group of 13 (31%) patients underwent traditional rehabilitation (physiotherapy, kinesiomasage, ergotherapy). Traditional rehabilitation and the anika gloves recovery method were used in 28 (68%) patients of the second group.

Results: In both groups, 3 rehabilitation courses were carried out over 3 months. The duration of each rehabilitation course is 10 days. As a result, in the 1st group, the activity of the hands increased by 30-40% due to a decrease of muscle tone in the hands and muscle strength increased from 1-2 points to 2-3 points. In the 2nd group, the activity of the hands increased by 45-60% due to a decrease of muscle tone and muscle strength increased from 1-2 points to 3-4 points ($P \leq 0.09$). There was an increase in the activation of movements in the fingers of the hands.

Conclusion: 1) Rehabilitation measures have shown that the use of Anika computer gloves method with the traditional rehabilitation method increases the effectiveness of treatment and in a short time has a positive effect on fine movements of the fingers.

2) In the comprehensive rehabilitation of patients with stroke, it is recommended to use the Anika computer gloves in order to restore fine motor skills of the hand.

Disclosure: Nothing to disclose.

EPR2220

RTMS increases BDNF levels in patients with posttraumatic chronic disorders of consciousness

E. Iazeva, L. Legostaeva, I. Bakulin, A. Poydasheva, A. Shabalina, D. Sergeev, N. Suponeva, J. Ryabinkina, M.A. Piradov

Research Center of Neurology, Moscow, Russian Federation

Background and aims: Brain-derived neurotrophic factor (BDNF) is known to be related to the regulation of neuroplasticity underlying cognitive functions recovery. In our research, we concentrated on its role in disorders of consciousness (DOC).

Methods: We included 26 chronic DOC patients, male/female 16/10, age 32±13 years. Etiology was traumatic/non-traumatic in 10/16 patients, respectively. Mean time after accident was 19±17 months. 14 patients were in vegetative state/unresponsive wakefulness syndrome (VS/UWS), mean Coma Recovery Scale-revised (CRS-r) score was 6±0.3; 12 patients were in minimally consciousness state (MCS), mean CRS-r score was 13±4.

We detected BDNF levels in serum and cerebrospinal fluid (CSF) by ELISE before and after 10 sessions of high-frequency repetitive transcranial magnetic stimulation (rTMS) over the left angular gyrus.

Results: We did not find any difference between BDNF levels in serum and CSF in VS/UWS and MCS patients, as well as any changes in its concentration before and after rTMS course in the whole group and in VS/UWS-MCS subgroups. However, we found higher CSF BDNF level in posttraumatic DOC patients (Table 1) and an increase of its concentration after rTMS course, unlike non-traumatic patients (Table 2). We also observed mild clinical improvement after rTMS in patients of both traumatic and non-traumatic etiology (Legostaeva et al., 2019).

Conclusion: BDNF levels in CSF were higher in posttraumatic DOC patients and increased after rTMS course application. This may contribute to the known more favourable outcome of DOC after traumatic brain injury. Yet, our finding requires further investigations.

Disclosure: The study is supported by Russian Science Foundation grant No 16-15-00274

Table 1. Baseline BDNF levels in DOC patients (n=26), pg/ml.

	VS/UWS	MCS	p (Mann-Witney U test)	Posttraumatic	Non-traumatic	p (Mann-Witney U test)
Serum	800 [510; 1010]	770 [675; 915]	1	750 [645; 875]	820 [560; 980]	0.897
CSF	13,8 [10,7; 31,4] *10 ³	20,5 [11,5; 27,2] *10 ³	0.494	28,4 [20,5; 38,3] *10 ³	13,3 [10,7; 19,9] *10 ³	0.036

Table 1

Table 2. Change of BDNF levels after rTMS course (n=21), pg/ml.

	Serum			CSF		
	Before rTMS	After rTMS	p (Wilcoxon signed-rank test)	Before rTMS	After rTMS	p (Wilcoxon signed-rank test)
Whole group	800 [660; 960]	800 [600; 1300]	0.862	14 [10.8; 26] *10 ³	15,6 [8.8; 22,4] *10 ³	0.258
VS/UWS	900 [560; 1070]	760 [510; 850]	0.463	13,6 [10,3; 27,2] *10 ³	15,6 [6,5; 21,5] *10 ³	0.235
MCS	770 [685; 875]	950 [735; 1330]	0.169	18 [11,2; 25,6] *10 ³	16,4 [13,5; 27,8] *10 ³	0.444
Posttraumatic	750 [655; 825]	800 [545; 1380]	0.575	30,2 [17,8; 44,6] *10 ³	38 [22,1; 50,5] *10 ³	0.017
Non-traumatic	900 [680; 1040]	800 [700; 1000]	0.906	11,6 [10,4; 17] *10 ³	13 [6; 15,6] *10 ³	0.814

Table 2

Peripheral nerve disorders 1

EPR2221

Spectrum of IgM-related neuropathies in a large French monocentric cohort

B. Bardel¹, J.-P. Lefaucheur¹, F. Le Bras²,
V. Molinier-Frenkel³, S.S. Ayache¹,
V. Planté-Bordeneuve⁴

¹Neurophysiology, Henri Mondor Hospital, Créteil, France,
²Lymphoid Hemopathy, Henri Mondor Hospital, Créteil,
France, ³Biological Immunology, Henri Mondor Hospital,
Créteil, France, ⁴Neurology, Henri Mondor Hospital, Créteil,
France

Background and aims: A sizable number of patients with a peripheral neuropathy have an IgM monoclonal gammopathy (IgM-MG) detected. The aim of this work was to study the spectrum of IgM-related neuropathies (IgM-NP) in a large monocentric cohort of patients with IgM-MG.

Methods: In this retrospective study we reviewed the neurological, neurophysiological, hematological findings and prognosis of patients with an IgM-MG detected by immunofixation between January 2010 and September 2015 in our center (Henri Mondor hospital, Créteil, France). Data were collected from the departments involved in the patients' care and from the centralized database Orbis.

Results: Among 604 patients with IgM-MG, 83 patients (14%) had an IgM-NP (59 males, mean age 67 y.o) including 41 patients with a dysimmune peripheral neuropathy (including 38 Anti-MAG neuropathies), 5 light chains deposits neuropathies (4 AL amyloidosis), 3 cryoglobulinemic neuropathies and 4 patients with neurolymphomatosis. Also, 30 patients suffered from asyndromic neuropathy including 23 with axonal neuropathy. Ataxia, tremor and upper limbs extension were statistically more frequent in dysimmune neuropathies. In AL amyloidosis, neuropathy occurred earlier with consistent small fibers alterations and often with a large fiber neuropathy during its course. Neurolymphomatosis occurred long after the IgM-MG diagnosis, with a good response to hematological treatment. Lastly, asyndromic neuropathies worsened for 1/3rd of the patients with a neuropathic response to hematological treatment in half of the patients treated.

Conclusion: This study emphasized the heterogeneity of the IgM-NP from the initial findings to the prognosis and gave insights on their therapeutic responses.

Disclosure: Nothing to disclose

EPR2222

Quality of life in hereditary neuropathy with liability to pressure palsies is as impaired as in Charcot-Marie-Tooth disease type 1A

B. Bjelica¹, S.Z. Peric¹, I. Bozovic¹, I. Basta², A. Kacar¹,
M. Janković¹, M. Branković³, A. Palibrk⁴, I. Novaković⁵,
D. Lavrnić², Z. Stevic¹, V. Rakocevic Stojanovic⁵

¹Belgrade, Serbia, ²Neurology Clinic, Clinical Center of Serbia, Belgrade, Serbia, ³Neurology Clinic, Clinical Center of Serbia, School of Medicine, University of Belgrade, Belgrade, Belgrade, Serbia, ⁴Center for Polyneuropathies, Neurology Clinic, Clinical Centre of Serbia, Belgrade, Serbia, ⁵Neurology Clinic, Clinical Center of Serbia, School of Medicine, University of Belgrade, Belgrade, Serbia

Background and aims: To date only one study assessed quality of life (QoL) in patients with hereditary neuropathy with liability to pressure palsies (HNPP). We aimed to fill in the gap by investigating QoL in cohort of patients with HNPP compared to Charcot-Marie-Tooth type 1A (CMT1A), as well as to analyze sociodemographic and clinical features associated with QoL in HNPP.

Methods: 18 genetically confirmed HNPP patients were age- and gender-matched with 18 CMT1A patients. SF-36 questionnaire was used to assess QoL. Medical Research Council (MRC) Sum Score, CMT Neuropathy Score (CMTNS), Overall Neuropathy Limitation Scale score (ONLS), Falls Efficacy Score (FES), Visual Analogue Pain Scale, Beck Depression Inventory (BDI) and Krupp's Fatigue Severity Scale (FSS) were also used in our study.

Results: Although HNPP patients were less clinically impaired, no difference was observed in these 2 cohorts regarding any of the SF-36 scores. Worse QoL in HNPP patients was associated with lower education ($p<0.01$), physical occupation ($p<0.05$), higher number of clinically affected nerves during disease course ($p<0.01$), worse MRC-SS score ($p<0.01$), worse ONLS scores ($p<0.01$), and with more pain ($p<0.01$), depression ($p<0.01$), and fatigue ($p<0.01$). Worse pain at the moment of testing appeared as a significant independent predictor of worse QoL in HNPP patients ($\beta=-0.93$, $p<0.001$).

Conclusion: QoL was similarly impaired in patients with HNPP and patients with CMT1A. We identified different factors that are associated with QoL in HNPP, and many of these are amenable to treatment which is of special interest in these still incurable diseases.

Disclosure: This study was supported by the Ministry of Education, Science and Technological Development of the Republic of Serbia (grant #175083).

EPR2223

Analysis of responsiveness of two different ability outcome measures in Guillain-Barré syndrome

I. Bozovic¹, A. Stojanov², I. Berisavac¹, M. Arsenijevic¹, O. Tamas Stojiljković¹, A. Palibrk³, B. Bjelica¹, S. Rajić⁴, B. Vujovic⁵, S. Vodopić⁵, M. Petrovic⁶, D. Aleksic⁶, A. Dominovic Kovacevic⁷, Z. Vukojevic⁷, M. Stojanovic⁶, Z. Jovin⁴, G. Djordjevic², I. Basta¹, S. Peric³

¹Belgrade, Serbia, ²Nis, Serbia, ³Neurology Clinic, Clinical Center of Serbia, School of Medicine, University of Belgrade, Belgrade, Serbia, ⁴Novi Sad, Serbia, ⁵Podgorica, Montenegro, ⁶Kragujevac, Serbia, ⁷Banja Luka, Bosnia and Herzegovina

Background and aims: Guillain-Barré syndrome disability scale (GDS) is the most commonly used ability measure in Guillain-Barré syndrome (GBS). Recently I-RODS has been developed as a new ability and participation scale to be used in inflammatory neuropathies, including GBS. GDS and I-RODS has not been compared in GBS patients so far. The objective of this study was to compare responsiveness of I-RODS and GDS in GBS patients during a six-month follow-up period.

Methods: GDS and I-RODS were administered in 72 patients from 7 tertiary health care centers from 3 countries. Using these measures patients were tested as follow: on day 14, day 28, month 3 and 6 months from symptom onset. Response was defined as an improvement for one point on GDS and improvement on I-RODS as defined by Draak et al (2014).

Results: Between day 14 and 28 there was an improvement in 28% patients as measured with GDS and only in 10% patients as measured with I-RODS. At month 3 compared to day 14 we noticed improvement in GDS score in 90% of GBS patients and in I-RODS score in 65%. At month 6 improvement was noticed in 94% of patients measured by GDS and 78% according to I-RODS.

Conclusion: Our findings support the use of GDS in an acute phase of GBS when gaining ability to walk is of outstanding importance for patients. On the other hand, it seems that I-RODS has its role during a longer follow-up period since being better by GDS does not necessarily mean doing well.

Disclosure: Nothing to disclose

EPR2224

Ibrutinib, an oral inhibitor of Bruton's tyrosine kinase, is active in anti-MAG antibody polyneuropathy.

C. Briani¹, A. Visentin², F. Castellani¹, M. Campagnolo³, A. Salvalaggio³, M. Cacciavillani¹, C. Candiottio⁴, R. Bertorelle⁵, L. Trentin²

¹Padua, Italy, ²Hematology and Clinical Immunology Unit, Department of Medicine, University of Padova, Padua, Italy,

³Neurosciences, University of Padova, Padua, Italy,

⁴Immunology and Molecular Oncology, Veneto Institute of Oncology IOV - IRCCS, Padua, Italy, ⁵Immunology and Molecular Oncology, Veneto Institute of Oncology IOV - IRCCS, Padua, Italy

Background and aims: Anti-myelin-associated glycoprotein (MAG) antibody neuropathy is a chronic sensorimotor demyelinating polyneuropathy, associated with IgM monoclonal gammopathy either of undetermined significance (MGUS) or Waldenström's Macroglobulinemia (WM). MYD88L265P is the most common mutation in WM and IgM-MGUS. Ibrutinib, an oral inhibitor of Bruton's tyrosine kinase, has been shown to be effective in WM, especially with MYD88L265P mutation and CXCR4 wild-type. We report on 3 anti-MAG neuropathy patients successfully treated with ibrutinib.

Methods: All 3 patients underwent bone marrow biopsy showing WM, with MYD88L265P mutated and CXCR4S338X wild-type, and were started on ibrutinib 420mg/die. Patients were assessed at baseline, at 3-6 months, and at 12 months in 2 patients with longer follow-up, using INCAT (Inflammatory Neuropathy Cause and Treatment) Disability Score, INCAT Sensory Sum Score (ISS) and Medical Research Council (MRC) sum score. The Modified International Cooperative Ataxia Rating Scale (mICARS) was performed in 2 patients, while it was not used in the patient with Parkinson's disease as major comorbidity. Responders were considered the patients improving by at least one point in 2 clinical scales.

Results: All the patients reported an early and subjective benefit, consistent with objective improvement especially of the sensory symptoms as shown by clinical scales. IgM levels and the monoclonal component steadily decreased. Therapy was well tolerated, and none developed atrial fibrillation. All the patients are still receiving treatment

Conclusion: These preliminary data point to a possible efficacy of ibrutinib in anti-MAG antibody neuropathy, which is the most common disabling paraproteinemic neuropathy.

Disclosure: Nothing to disclose

EPR2225

Video head impulse test findings in patients with chronic inflammatory demyelinating polyradiculoneuropathy

Z. Calic¹, S. Peric², I. Bozovic², B. Bjelica², M. Vujnic³, I. Basta⁴, M. Welgampola⁵

¹Department of Neurophysiology, South Western Sydney Clinical School, University of New South Wales, Liverpool Hospital, Liverpool, Australia, ²Neurology Clinic, Clinical Center of Serbia, School of Medicine, University of Belgrade, Belgrade, Serbia, ³Department of Pathophysiology, Faculty of Medicine, University of Banja Luka, Republic of Srpska, Bosnia and Herzegovina, ⁴Neurology Clinic, Clinical Center of Serbia, Belgrade, Serbia, ⁵Institute of Clinical Neurosciences, Royal Prince Alfred Hospital, Sydney, Australia

Background and aims: Chronic inflammatory demyelinating polyradiculoneuropathy (CIDP) is treatable, autoimmune peripheral neuropathy. This study analyses the vestibulo-ocular reflex (VOR) as measured by the video-head impulse test (v-HIT).

Methods: 10 patients (age 54.7±21.8, 5F/5M) with CIDP, mean disease duration of 4.2 years, mean MRC Sum Score of 51.9±5.5, mean Inflammatory Neuropathy Cause and Treatment (INCAT) disability score 2.4±0.8 were recruited from an Outpatient Neurology Clinic. 3-dimensional v-HIT was performed. VOR-gain, refixation saccade prevalence and 1st saccade amplitude, onset and duration were examined and compared against age-matched healthy controls.

Results: 6 of 10 patients reported severe imbalance resulting in recurrent falls in 4 patients, 1 patient reported past history of vertigo/dizziness. Horizontal, anterior and posterior canal (HC, AC, PC) VOR-gains for CIDP were 1.0±0.1, 0.90±0.2, 0.78±0.2 and for controls were 0.95±0.1, 0.91±0.1, and 0.82±0.1. VOR-gain was reduced (mean±2SD) in 55 patients. Refixation saccade prevalence for HC, AC, PC were 52%, 23%, 59% in CIDP and 60%, 24% and 54% in controls. 1stsaccade onset latency was longer for HC and PC in CIDP group (p<0.05). Reduced VOR-gain was associated with history of recurrent falls (p<0.05).

Conclusion: Reduction in the VOR-gain is common, and refixation saccades tend to occur later in patients with CIDP. Our findings indicate that gait imbalance in CIDP may be also linked to vestibular impairment. Complementary otolith function testing is necessary to better characterise pattern of vestibular impairment in patients with CIDP.

Disclosure: Nothing to disclose

EPR2226

Interim Analysis of a Post-authorisation Safety Study on the Long-Term Safety of Hyaluronidase-Facilitated Subcutaneous Immunoglobulin 10% in Patients with Primary Immunodeficiency Diseases in Europe

P.M. Ellerbroek¹, P. Van Paassen², L. Hanitsch³, A. Plebani⁴, R.E. Schmidt⁵, P.M. Van Hagen⁶, P. Wang⁷, K. Fielhauer⁸, H. Leibl⁸, S. Chavan⁷, L. Yel⁹

¹Department of Internal Medicine and Infectious Diseases, University Medical Centre Utrecht, Utrecht, Netherlands, ²Academisch Ziekenhuis Maastricht, Maastricht, Netherlands, ³Institut für Medizinische Immunologie Charité Universitätsmedizin Berlin, Berlin, Germany, ⁴Department of Clinical and Experimental Sciences, University of Brescia and ASST Spedali Civili di Brescia, Brescia, Italy, ⁵Klinik für Immunologie und Rheumatologie, Medizinische Hochschule Hannover, Hanover, Germany, ⁶Department of Internal Medicine, Erasmus University Medical Center, Rotterdam, Netherlands, ⁷Shire US Inc, a Takeda company, Lexington, USA, ⁸Baxalta Innovations GmbH, a Takeda company, Vienna, Austria, ⁹Baxalta US Inc, a Takeda company, Cambridge, USA

Background and aims: Recombinant human hyaluronidase (rHuPH20)-facilitated subcutaneous immunoglobulin (fSCIG) 10% is a novel therapy that utilises rHuPH20 to catalyse the hydrolysis of hyaluronan in the extracellular matrix. The resultant increase in subcutaneous tissue permeability enables administering fSCIG at rates, volumes and frequencies similar to intravenous immunoglobulin. We report fSCIG safety data from the interim analysis of an ongoing observational study in patients with primary immunodeficiency diseases (PID).

Methods: This prospective, non-interventional, open-label, uncontrolled, multicentre study, initiated July 2014 in Europe, includes patients aged ≥18 years with PID currently receiving fSCIG (EUPAS5812).

Results: This safety analysis includes 103 of 111 enrolled patients who received ≥1 dose of fSCIG as of 10 January 2019; the mean (SD) fSCIG exposure duration was 2.26 (1.19) years. Incidence of treatment-emergent non-serious (non-infectious) adverse events/treatment-emergent serious adverse events was 2.37/0.24 events per person-year; 553/57 events were observed in 83/28 patients. No neutralising antibodies to rHuPH20 were detected. The median immunoglobulin dose administered was 80.9 (range: 1.3–275.5) mg/kg body weight/week. The proportion of fSCIG administered at home was 91.2% in the first, 93.2% in the second, 93.2% in the third, and 85.2% in the fourth year.

Conclusion: This interim analysis of prospectively collected fSCIG data suggests fSCIG is well tolerated in a real-world population. The volume advantage of fSCIG makes it an attractive candidate in PID. This advantage becomes even more important in diseases requiring higher doses of immunoglobulin, such as chronic inflammatory

demyelinating polyradiculoneuropathy (CIDP). A phase 3 trial of fSCIG in CIDP is ongoing (NCT02549170).

Disclosure: This work was funded by Shire US Inc, a Takeda company.

EPR2227

Clinical heterogeneity of hereditary ATTR amyloidosis related to V30M mutation (hATTRm): experience of a Portuguese reference amyloidosis centre

P. Coelho, C. Campos, I. Conceicao

Neurology, Department of Neurosciences and Mental Health, Hospital de Santa Maria, Centro Hospitalar Universitário Lisboa Norte, Lisbon, Portugal

Background and aims: Cardiomyopathy has been considered rare in Portuguese hATTRV30M patients, contributing to diagnostic delay. We aim to perform a phenotypical description of hATTRV30M mutation symptomatic patients followed at a specialized tertiary centre in Portugal.

Methods: Retrospective cross-sectional study of symptomatic hATTR patients followed in the last 5 years. Demographic and clinical variables were obtained from hospital clinical registries. Patients were classified as early-onset (<50 years old) or late-onset (\geq 50 years old) according to beginning of 1st symptoms. Cardiomyopathy was defined as septal thickness >13mm and/or DPD Scan=3.

Results: 231 patients were included (female gender 48%) with a mean symptoms' age of onset of 41.9 years old (SD \pm 13.9). From those, 58 (n=25.4%) were classified as late onset patients. Neuropathic phenotype was present in 71 patients (30.7%), mixed phenotype in 150 (64.9%) and cardiac phenotype in 5 patients (2.2%). Neuropathy was present in 166 (92.5%) early onset patients and in 57 (96.6%) late onset patients. Cardiac autonomic manifestations were present in 114 (66.3%) early onset and in 32 (55.2%) late onset patients (p=0.102). Cardiomyopathy was seen in 31 (52.5%) late onset patients and in only 6.9% (n=12) of the early onset group (p<0.001).

Conclusion: hATTRV30 amyloidosis have a phenotype difference regarding the age of onset. Cardiomyopathy can be present in V30M population, more often in the late onset group, demystifying the idea that in this population there is only an early onset neuropathic or mixed phenotype.

Disclosure: Nothing to disclose

EPR2228

Objective markers for onset of transthyretin familial amyloid polyneuropathy in asymptomatic ser77tyr mutation carriers

A. Dori, V. Nikitin, A. Hersalis-Eldar, M. Ben-David
Neurology, Sheba Medical Center, Ramat-Gan, Israel

Background and aims: Transthyretin familial amyloid polyneuropathy (TTR-FAP) in Israel is commonly due to Ser77Tyr mutation in the TTR gene, identified among Jewish Yemenite descents. Disease onset due to this mutation is usually after the age of 50, with unknown penetrance and fatal within a few years. Early treatment delays disease progression, therefore timely diagnosis of disease-onset is imperative for effective management. Congo-red staining of amyloid deposits is the most objective evidence for active disease, effectively tested in skin punch biopsy, which also enables small fiber neuropathy (SFN) diagnosis by quantifying the intra-epidermal nerve fiber density (IENFD). However, while low IENFD may mark the pre-symptomatic phase of TTR-FAP, it is non-specific, occurring in SFN due to a variety of etiologies.

Methods: We assessed for objective disease hallmarks in asymptomatic TTR Ser77Tyr mutation carriers that have active disease per Congo-red staining.

Results: 11 carriers were identified, which were asymptomatic or had non-specific intermittent neuropathic symptoms with normal IENFD. 2 asymptomatic carriers showed amyloid in skin, accompanied by low IENFD and showed a median neuropathy at the wrist. An additional asymptomatic carrier with a median neuropathy at the wrist attributed to recurrent carpal tunnel syndrome during pregnancies had no amyloid deposits and normal IENFD. 8 carriers showed no median neuropathy at the wrist, 2 had low IENFD but no amyloid and in 3, a skin biopsy was not obtained due to young age.

Conclusion: Electrophysiological evidence for a median neuropathy at the wrist accompanied by skin denervation in asymptomatic mutation carriers suggests active TTR-FAP.

Disclosure: Honorarium for lectures by Pfizer.

EPR2229

Management of Thrombocytopenia in Patients With Hereditary Transthyretin Amyloidosis Treated With Inotersen: Clinical Trial and Postmarketing Surveillance Experience

M. Gertz¹, S. Khella², A. Wang³, T. Coelho⁴, M. Waddington Cruz⁵, M.J. Polydefkis⁶, V. Planté-Bordeneuve⁷, J.L. Berk⁸, F. Barroso⁹, T.H. Brannagan Iii¹⁰, G. Merlini¹¹, L. Obici¹¹, I. Conceicao¹², S.W. Jung¹³, S.G. Hughes¹³, P. Aquino¹⁴, L.S.L. O’dea¹⁴, A. Narayana¹⁴, N. Dasgupta¹⁵, M.D. Benson¹⁵

¹Mayo Clinic, Rochester, USA, ²University of Pennsylvania, Philadelphia, USA, ³University of California, Irvine, Orange, USA, ⁴Centro Hospitalar do Porto, Porto, Portugal, ⁵Federal University of Rio de Janeiro, University Hospital, Rio de Janeiro, Brazil, ⁶Johns Hopkins University, Baltimore, USA, ⁷CHU Henri Mondor, Creteil, France, ⁸Boston University, Boston, USA, ⁹FLENI, Buenos Aires, Argentina, ¹⁰Columbia University Medical Center, New York, USA, ¹¹Amyloidosis Research and Treatment Centre, Fondazione IRCCS Policlinico San Matteo, Pavia, Italy, ¹²CHLN—Hospital de Santa Maria, Lisbon, Portugal, ¹³Ionis Pharmaceuticals Inc, Carlsbad, USA, ¹⁴Akcea Therapeutics, Boston, USA, ¹⁵Indiana University School of Medicine, Indianapolis, USA

Background and aims: Hereditary transthyretin amyloidosis (hATTR) is a rare, progressive, fatal disease causing debilitating autonomic and sensorimotor neuropathy. Efficacy and safety of inotersen, an antisense oligonucleotide inhibitor of transthyretin protein production, were evaluated in a randomized, placebo-controlled pivotal study (NEURO-TTR) and its open-label extension (OLE). During the NEURO-TTR trial, weekly monitoring of platelet counts was implemented after 3 (3%) cases of grade 4 thrombocytopenia (platelet count <25×10³/μL) were reported. This analysis assesses outcomes of enhanced monitoring for thrombocytopenia in patients receiving inotersen in the clinical trial and real-world setting.

Methods: Patients with hATTR received inotersen through NEURO-TTR, OLE, a US expanded access program (EAP), a French compassionate use program (ATU), and an investigator-sponsored trial (IST; includes patients with wild-type ATTR). Data from these 5 studies plus ~3 patient-years of postmarketing exposure were evaluated from 6 July 2018 to 5 January 2019. Data from the US Risk Evaluation and Mitigation Strategy (REMS) were evaluated from 8 October 2018 to 6 August 2019.

Results: As of 5 January 2019, 267 unique patients received inotersen: NEURO-TTR N=112, OLE N=135, EAP N=66, ATU N=2, and IST N=36. Since the implementation of enhanced monitoring in clinical trials, noninterventional studies, and the ongoing REMS program, no cases of grade 4 thrombocytopenia or serious bleeding with severe thrombocytopenia have been reported to date.

Conclusion: With enhanced safety monitoring, events of grade 4 thrombocytopenia or serious bleeding with severe

thrombocytopenia have been successfully mitigated across all current clinical studies and treatment programs.

Disclosure: This study was sponsored by Akcea Therapeutics and Ionis Pharmaceuticals, Inc.; medical writing support was provided by ApotheCom and funded by Akcea Therapeutics.

EPR2230

Argentinean Study in Transthyretin Familial Amyloid Polyneuropathy. "An old illness that we need to think"

L. Leon Cejas¹, C. Calandra², M.E. Conti³, F. Aguirre⁴, A. Rodriguez⁵, P. Landricina⁵, R. Pedelhez⁵, M. Cordoba⁵, M. Chaves⁶, M. Rugiero⁷, C. Marchesoni¹, A. Pardal¹, F. Barroso⁸, R. Reisin⁹

¹Neurology, Hospital Británico, Buenos Aires, Argentina,

²Neurology, El Cruce Hospital, BUENOS AIRES, Argentina,

³Neurology, Clinicas Hospital, BUENOS AIRES, Argentina,

⁴Neurology, Ramos Mejias Hospital, BUENOS AIRES,

Argentina, ⁵Neurology, Ineba Institute, BUENOS AIRES,

Argentina, ⁶Neurology, San Martin Hospital, Entre Rios,

Argentina, ⁷Neurology, Italiano Hospital, BUENOS AIRES,

Argentina, ⁸FLENI, Ciudad Autónoma de Buenos Aires,

Buenos Aires, Argentina, ⁹Buenos Aires, Argentina

Background and aims: Transthyretin familiar amyloid polyneuropathy (TTR-FAP) has an elevated prevalence in Portugal, Sweden, Japan and Brazil with an aggressive course and high morbi-mortality without an effective treatment. Our objective is to report the identified Argentinean cases.

Methods: Retrospective, multicentric and clinical-epidemiological study.

Results: We identified 94 patients, 45 females. Mean age 35 years old (range 12-78). 98% were born in Argentina, the rest in Bolivia and Perú. The majority of them lived in Buenos Aires (90.21%) and in provinces as Chaco (7.60%), Formosa (1.08%) and Entre Rios (1.08%). Val 30 met was the most common mutation (89.36%) followed by Ala97ser (6.38%), Tyr114cys (2.12%), Ile93val (1.06%) and Ala36pro (1.06%). The ancestors came from Portugal, Spain, Italy, France and Taiwan. The latency between the onset of symptoms and diagnosis was 1 to 10 years. The delay was justified by alternative diagnosis as CIDP (4), ALS (2), lumbar spinal stenosis (2), diabetic neuropathy (2), syringomyelia (2), vitamin b12 deficiency (1), psychogenic (6). 63 patients were symptomatic, 42 had an early onset with a small fibre neuropathy at the presentation, some of them with dysautonomic manifestations as digestive (40), genitourinary (28) and cardiac (22). Renal involvement, ocular and central nervous systems were referred in 10 patients. 35 patients were in the 1st stage of FAP disease scale, 13 in stage 2 and 9 in the 3rd. Some of them were treated with liver transplant and others received tafamidis and inotersen. Died 13 patients.

Conclusion: TTR-FAP is still an underdiagnosed illness in Argentina.

Disclosure: Nothing to disclose

EPR2231

Sensory neuropathies at a single tertiary center: A case series and application of Camdessanché diagnostic criteria

B. Meira¹, M. Fernandes¹, F. Ladeira², E. Medeiros¹, L. Santos¹, A. Caetano¹

¹Neurology Department, Hospital Egas Moniz, Centro Hospitalar Lisboa Ocidental, Lisbon, Portugal, ²Neurology, Centro Hospitalar Universitário Lisboa Central, Lisbon, Portugal

Background and aims: Sensory neuropathies (SN) are a rare subtype of peripheral neuropathy resulting from dorsal root ganglion degeneration. The etiological diagnosis is divided into autoimmune, paraneoplastic, infectious, toxic, hereditary and in a percentage of cases remains idiopathic. Camdessanché et al established a set of criteria to differentiate SN from other sensory neuropathies.

Methods: Description of patients diagnosed with SN at Hospital Egas Moniz between 2006 and 2019 and retrospective application of the Camdessanché criteria.

Results: We present 23 patients (11 men), aged between 37 and 93 years. The average age of onset was 61.2 years. The phenotype was typically progressive (50.0%), with hyposthesia (90.5%), ataxia (54.5%), and 4-limb involvement (69.6%). Objectively, 56.5% had a pansenitive deficit, 60.9% appendicular ataxia and 72.7% Romberg sign. Aetiologically, 10 patients (43.5%) have a defined etiology (Sjögren, Chemotherapy-induced, HIV, CANVAS Syndrome, Mitochondrial Cytopathy, Vitamin Deficiency) and in the remaining (56.5%) no etiology was identified. The average follow-up was 6.4 years. Applying the Camdessanché criteria, 17 met criteria for possible SN (mean score 9.6) and 4 for probable SN (history of exposure to cisplatin and Sjögren). It was also possible to fit 16 patients into A-D patterns (agreeing with that described by the same author).

Conclusion: Our series differed from other series reported by the higher percentage of idiopathic cases and the absence of paraneoplastic cases. We testified that Camdessanché criteria can be easily applied and have a good sensitivity as previously reported. SN are a rare disorder with a challenging etiological diagnosis.

Disclosure: Nothing to disclose

Sleep disorders 2

EPR2232

Startle Reflex modulation in patients with REM Sleep Behavior Disorder

M. Figorilli¹, R. Frau², F. Traccis², M. Carta², P. Devoto², D. Pani³, M.L. Fantini⁴, M. Bortolato⁵, M.M.F. Puligheddu¹

¹*Sleep Disorders Center, Department of Medical Sciences and Public Health, University of Cagliari, Cagliari, Italy,* ²*Department of Biomedical Sciences, University of Cagliari, Cagliari, Italy,* ³*DIEE, Dept. of Electrical and Electronic Engineering, University of Cagliari, Cagliari, Italy,* ⁴*EA7280 NPsy-SyDo, UFR Médecine, Université Clermont-Auvergne, Clermont-Ferrand, France,* ⁵*Pharmacology and Toxicology, University of Utah, Salt Lake City, USA*

Background and aims: RBD may be isolated (iRBD) or associated with Parkinson's disease (PDRBD). RBD derives from an imbalance in different areas of the brainstem, including those involved in the startle reflex. Our aim is to assess the Startle Reflex in patients with iRBD and PDRBD. **Methods:** A total of 60 subjects (20 iRBD, 20PDRBD and 20 healthy controls) were recruited from the Movement Disorder and Sleep Centers in Cagliari. RBD and PD diagnosis was made according to current criteria. The study included 1-night video-polysomnography recording, neuropsychological assessment and [123I]-FP-CIT dopamine transporter (DAT) scan where a semi-quantitative-age-adjusted basal nuclei values BasGanV2 algorithm was used. Startle Reflex was acquired by means of SR-HLABTM EMG and latency and amplitude measured. All indices will be compared between groups by 2-way analyses of variance (ANOVAs).

Results: 20PDRBD patients (M=18; mean age: 67.8±7.5 yrs, mean education 9.1±4.1 yrs), 20 iRBD patients (M=17; age:70.5±8.2; edu: 8.7±4.1 yrs.) and 20 sex- and age-matched control were enrolled. Among iRBD patients, n=15 had abnormal DAT-Scan and n=6 were found to have a Mild Cognitive Impairment. An alteration of the startle reflex (latency prolongation) was observed in iRBD and PDRBD, compared to healthy controls (ANOVA 1-way p<0.05), while no difference in amplitude was found.

Conclusion: Startle reflex is altered in both iRBD and PDRBD patients. Changes in iRBD may indicate an early expression of the neurodegenerative process underlying this disorder at the brainstem level, persisting in PDRBD. Startle Response might represent a tool to explore brainstem neurophysiology in RBD.

Disclosure: Nothing to disclose

EPR2233

Investigation on neurexin 1 alpha antibodies in narcolepsy and other hypersomnias

M.P. Giannoccaro¹, F. Pizza¹, R. Liguori¹, G. Plazzi¹, A. Vincent²

¹*Biomedical and Neuromotor Sciences (DIBINEM); IRCCS Istituto delle Scienze Neurologiche, University of Bologna, Bologna, Italy,* ²*Oxford, United Kingdom*

Background and aims: Neurexin 1 alpha (NRXN1) has been suggested as a possible autoantigen in narcolepsy patients. Our aim was to investigate the frequency of antibodies (abs) against NRXN1 in a group of patients with narcolepsy and other sleep disorders using a newly established cell-based assay.

Methods: Sera from 59 type 1 (NT1) and 15 type 2 (NT2) narcolepsy patients, 10 patients with idiopathic hypersomnia and 11 patients with hypersomnia but otherwise normal sleep studies (sEDS) were studied. Human embryonic kidney cells were transiently transfected with human NRXN1 encoding plasmid, incubated with patients' sera for 1 hour at 1:100 dilution and then fixed. Binding of antibodies was detected by fluorescently-labelled secondary antibodies to human IgG and the different IgG subclasses. A non-linear visual scoring system was used from 0 to 4; samples scoring ≥1 were considered positive. End-point titers were established on positive samples.

Results: 3 out of 95 sera (3.1%) tested positive with end-point titers between 1:500 and 1:2500. Subclass analysis showed that antibodies were IgG1. Positive cases included 1 male NT1 patient and two female sEDS patients. None of them had an acute onset of the disease and all were sampled far from onset.

Conclusion: Antibodies to NRXN1 are very rare in patients with narcolepsy.

Disclosure: Nothing to disclose

EPR2234

Do Depression and Anxiety Depend on Insomnia Phenotypes in Patients with Epilepsy?

M. Isayan, H. Hovakimyan, S. Khachatryan
Sleep and Movement Disorders Center, Somnus Neurology Clinic, Yerevan, Armenia

Background and aims: Insomnia is a frequent co-morbidity in patients with epilepsy (PWE). It also accompanies depression and anxiety. 2 main insomnia phenotypes are recognized: sleep-onset (SOI) or sleep-maintenance (SMI). We aimed to study the relationship of insomnia phenotypes with depression and anxiety in PWE.

Methods: 2 groups of participants were interviewed at a sleep center: epilepsy patients with insomnia group (EIG) and patients with insomnia group (IG). We tested them using Hamilton depression and anxiety rating scales (HAMD, HAMA) and Pittsburgh Sleep Quality Index (PSQI). Participants were classified into predominantly SOI or SMI phenotype subgroups according to clinical interview and specific points in HAMD.

Results: We interviewed 175 PWE, 90 of them had insomnia comprising EIG – mean age-37.5, F-43.3% (SOI-32.2%, SMI-67.8%). Data from IG consisting of 31 insomnia patients were also studied, mean age-41.1, F-61.3% (SOI-16.1%, SMI-83.9%). In EIG mean scores for HAMA, HAMD, and PSQI for SOI/SMI subgroups were respectively: HAMA 13.5/22.2, HAMD 11.9/8.7, PSQI 8.2/12.3 ($p < 0.05$). Interestingly, no differences were found between SOI/SMI subgroups in IG: HAMA 19.4/17.4, HAMD 12.6/15.4, PSQI 14.2/14.8 ($p > 0.05$).

Conclusion: Our results show that sleep-maintenance insomnia was associated with higher rates of depression, anxiety and poor sleep quality in epilepsy patients compared to sleep-onset phenotype. We did not find similar relationship within insomnia population. This is the 1st report supporting that depending on insomnia phenotype depression and anxiety are influenced differently in epilepsy patients.

Disclosure: Nothing to disclose

EPR2235

Pitolisant in the Treatment of Patients With Narcolepsy: A 2-Year, Prospective, Observational, Single-Center Study

A. Triller, A. Hof Zum Berge, B. Finger, U. Kallweit
Clinical Sleep and Neuroimmunology, University Witten/Herdecke, Witten, Germany

Background and aims: The efficacy of pitolisant, a selective histamine H3 receptor inverse agonist, in adults with narcolepsy was demonstrated in randomized, placebo-controlled trials. This study evaluated long-term use of pitolisant in clinical practice.

Methods: This prospective, open-label, 2-year, observational study was conducted at a major narcolepsy center in Germany and enrolled adults with a diagnosis of narcolepsy who had no prior treatment with pitolisant. Assessments included excessive daytime sleepiness (Epworth Sleepiness Scale [ESS]), weekly rate of cataplexy (WRC), and health-related quality of life (Short-Form Veterans RAND [VR-36]).

Results: The study enrolled 147 patients: mean age, 29.9 years; 57.1% female, 65.3% with cataplexy, and 66.7% with disrupted nighttime sleep. Most patients received concomitant narcolepsy medications (63.3% at baseline; 79.6% at month 24). Mean ESS score decreased from 16.2 at baseline to 12.6 at Month 24. Mean WRC was reduced by 31% at Month 24. Significant improvement in quality of life was noted on VR-36 subscales that assess general health perception, vitality, and social function. In all, 38 patients (25.8%) discontinued from the study before Month 24: 15.0% for lack of efficacy and 10.8% due to adverse events. The most common adverse events were disrupted nighttime sleep (29.3% of patients), headache (15.5%), and nausea (12.2%).

Conclusion: These real-world data show that long-term treatment with pitolisant (usually with 35.6mg/d) was efficacious for reducing EDS and cataplexy and improving quality of life in patients with narcolepsy. Treatment was generally well tolerated.

Disclosure: Writing support funded by Harmony Biosciences, LLC.

EPR2236

Discovery of a novel, orally available orexin 2 receptor-selective agonist, TAK-988, as a potential therapeutic drug for narcolepsy.

H. Kimura, T. Ishikawa, Y. Kajita, Y. Miyanoohana, T. Koike, M. Suzuki

Neuroscience Drug Discovery Unit, Research, Takeda Pharmaceutical Company Limited, Fujisawa, Japan

Background and aims: The loss of orexin-producing neurons in lateral hypothalamus is associated with narcolepsy type 1 (NT1). Orexin 2 receptor (OX2R), but not orexin 1 receptor (OX1R), knockout (KO) mice show clear narcolepsy-like phenotypes. Selective activation of OX2R may be effective for treatment of narcolepsy. In this study, we characterized in vitro and in vivo profiles of a novel, orally available OX2R-selective agonist, TAK-988.

Methods: A calcium mobilization assay in Chinese hamster ovary (CHO) cells stably expressing human OX2R was used to assess OX2R-agonistic activity. To investigate the activation of OX2R-downstream signals, inositol monophosphate contents, beta-arrestin recruitment, and phosphorylation of extracellular signal-regulated kinase 1/2 and cAMP response element-binding protein were measured in CHO cells stably expressing ProLink-tagged human OX2R and beta-arrestin2-beta-gal-EA fusion protein. Electrophysiological studies were conducted to assess the activation of physiological OX2R on histaminergic neurons in the mouse tuberomammillary nucleus (TMN). Electroencephalogram/electromyogram recordings with wild-type (WT) mice and OX2R KO mice were performed during sleep phase to evaluate TAK-988 mediated arousal effects.

Results: TAK-988 activated OX2R (EC50 value: 2 nM) in the calcium mobilization assay, and induced OX2R-downstream signaling similar to orexin peptides in vitro. TAK-988 also activated physiological OX2R on histaminergic neurons in the mouse TMN in vitro. Oral administration of TAK-988 promoted wakefulness in WT mice, but not in OX2R KO mice, confirming its OX2R selectivity in vivo.

Conclusion: The orally available TAK-988, OX2R agonist may have potential as a new treatment option for individuals with NT1 as well as other hypersomnia disorders with normal orexin levels.

Disclosure: Nothing to disclose

EPR2237

The Vitamin D Receptor Gene FokI Polymorphism is associated with susceptibility to Sleep Disorders

B. Leal¹, S. Brás², A.M. Ferreira³, R. Martins-Ferreira¹, C. Carvalho¹, A. Bettencourt¹, J. Ramalheira⁴, J. Lopes⁴, B. Silva¹, P. Pinho E Costa⁵, A. Martins Da Silva⁶

¹Autoimmu and NeuroScien, Unidade Multidisciplinar Invest Biomed, Inst Ciencias Biomed Abel Salazar, UPorto, Porto, Portugal, ²Unit for Multidisciplinary Research in Biomedicine (UMIB), Abel Salazar Institute of Biomedical Sciences, University of Porto – ICBAS/UP, Porto, Portugal, ³Lab. Imunogenética- ICBAS, UPorto, , Porto, Portugal, ⁴Neurophysiology Service, Hospital de Santo António - Centro Hospitalar e Universitário do Porto, Porto, Portugal, ⁵Department of Human Genetics, Instituto Nacional de Saúde Dr. Ricardo Jorge, Porto, Portugal, ⁶Hospital Santo António - Centro Hospitalar do Porto, Porto, Portugal

Background and aims: Immune-mediated mechanisms are thought to be implicated in some Sleep Disorders (SD). Vitamin D is a pleiotropic hormone with specific functions in the Immune and the Central Nervous System (CNS). It acts through a nuclear receptor (Vitamin D Receptor - VDR) expressed in all immune cells including microglia. Low vitamin D levels have been reported in narcoleptic patients. Function and expression of VDR is influenced by several known polymorphisms. One of these, FokI, has been recently associated with obstructive sleep apnea syndrome in a Greek population. Our aim was to investigate whether FokI polymorphism is associated with SD susceptibility and presentation in a Portuguese cohort.

Methods: We studied 133 SD patients (39 Narcolepsy Type1; 28 Narcolepsy Type 2 and 66 with Hypersomnia) followed at the Sleep Outpatient Clinic of HSA/CHP and 446 healthy individuals. The clinical picture was assessed by night PSG+Day MSLT. FokI was genotyped using a pre-designed TaqMan allelic discrimination assay.

Results: A statistically significant higher frequency of the TT genotype was observed in SD patients (16.5% vs. 10.1%, p=0.027, OR (95% CI)=1.77(1.02-3.07)) relative to controls. This difference was particularly relevant in Narcolepsy Type 1 patients (p=0.04; OR=2.30).

Conclusion: The FokI T allele translation product has lower transcriptional activity and results in a longer and less abundant transcript with a negative impact in the efficiency of transduction of the vitamin D signal. Thus, it is possible that individuals with the TT genotype could be prone to unbalanced T-cell responses leading to the development of immune-mediated sleep disorders.

Disclosure: Nothing to disclose

EPR2238

Narcolepsy type 1 features through the lifetime: age impact on clinical phenotype

A. Lividini¹, M. Filardi², F. Pizza², F.I.I. Cosentino³, R. Ferri⁴, B.M. Guarnieri⁵, S. Marelli⁶, L. Ferini-Strambi⁶, A. Romigi⁷, E. Bonanni⁸, M. Maestri⁹, R. Manni¹⁰, G. Plazzi¹¹

¹Department of Medical and Surgical Sciences (DIMEC), University of Bologna, Bologna, Italy, ²Department of Biomedical and Neuromotor Sciences, Università di Bologna - Alma Mater Studiorum, Bologna, Italy, ³Department of Neurology IC, IRCCS Oasi Maria SS., Troina, Italy, ⁴Sleep Research Center, Department of Neurology IC, Oasi Research Institute - IRCCS, Troina, Troina, Italy, ⁵Center of Sleep Medicine, Dept. Neurology Villa Serena Hospital,, Pescara, Italy, ⁶Department of Clinical Neurosciences, IRCCS San Raffaele Scientific Institute, Neurology - Sleep Disorders Centre, Milan, Milan, Italy, ⁷Department of Systems Medicine, University Hospital of Rome Tor Vergata, Rome, Italy, ⁸Department of Clinical and Experimental Medicine, Neurology Unit, University of Pisa, Pisa, Italy, ⁹PISA, Italy, ¹⁰C. Mondino National Neurological Institute, Pavia, Italy, Pavia, Italy, ¹¹Department of Biomedical and Neuromotor Sciences (DIBINEM), University of Bologna,, Bologna, Italy

Background and aims: Narcolepsy type 1 (NT1) is a chronic neurological disorder typically arising during adolescence and young adulthood. Nonetheless, NT1 clinical picture is mostly known in adults after a long delay in diagnosis. The present study was therefore set to characterize NT1 clinical pictures in different age groups of patients.

Methods: A total of 106 consecutive NT1 subjects underwent clinical and polysomnographic examinations and completed the Epworth Sleepiness Scale (ESS). Clinical features of core narcolepsy symptoms were evaluated through semi-structured interview. Patients belonging to 5 age groups (childhood, adolescence, early and late adulthood and old age) were contrasted.

Results: The ESS showed a significant increase with age, while the duration of total daytime sleep (min/day) was lower in elderly subjects and in younger adults, the latter also complaining more automatic behaviors, compared to other age groups.

As cataplexy triggers, “anger” and “meeting someone unexpectedly” were reported in the majority of adult and elderly patients, but only sporadically in patients’ <11 years-old. Children presented increased occurrence of cataplexy (>1/day in 95% of cases) and reported a time-of-day effect on cataplexy frequency (65%).

Conclusion: EDS and cataplexy variably presented in NT1 at different age, a finding that may contribute to the long diagnostic delay and the high misdiagnosis rate.

Disclosure: Nothing to disclose

EPR2239

Motor patterns of Disorders of Arousal (DoA) in adults. A video-polysomnographic analysis of 300 episodes

G. Loddo¹, E. Sessagesimi², F. Mignani³, F. Cirignotta⁴, S. Mondini⁴, L. Licchetta⁵, F. Bisulli⁵, P. Tinuper⁵, F. Provini⁵

¹Department of Biomedical and Neuromotor Sciences, University of Bologna, BOLOGNA, Italy, ²Radiology Unit, Department of Experimental, Diagnostic and Specialty Medicine, Sant’Orsola-Malpighi Hospital, University of Bologna, Bologna, Italy, ³Ospedale Bellaria, IRCCS Istituto delle Scienze Neurologiche, BOLOGNA, Italy, ⁴Department of Head, Neck and Sensory System, Neurology Unit, Sant’Orsola-Malpighi Hospital, University of Bologna, BOLOGNA, Italy, ⁵Department of Biomedical and Neuromotor Sciences, IRCCS Istituto delle Scienze Neurologiche di Bologna, University of Bologna, BOLOGNA, Italy

Background and aims: Disorders of Arousal (DoA) are NREM parasomnias typically considered as self-limited childhood manifestations. It is now clear that DoA can persist in adults, often presenting with distinctive characteristics. Nevertheless, few video-polysomnographic (VPSG) studies described the semeiology of DoA episodes in adulthood.

Methods: We reviewed 93 nocturnal VPSG recordings of 40 adult patients (>15 years). We scrutinized the semeiology of the episodes recorded, classifying them into 3 groups according to 3 semeiological motor patterns with increasing intensity and complexity: Simple Arousal Movements (pattern I or SAMs), characterized by head flexion/extension, head flexion/extension and limb movement or head flexion/extension and partial trunk flexion/extension; Rising Arousal Movements (pattern II or RAMs), characterized by a complete trunk flexion with patient sitting up in bed; Complex Arousal with Ambulatory Movements (pattern III or CAMs) characterized by Sleepwalking. The V-PSG recordings were compared to those of 15 healthy controls.

Results: 300 episodes were recorded: 248 (82%) SAMs, 34 (11%) RAMs, and 18 (7%) CAMs. Episodes lasted 33±35 seconds as a mean. Movements tended to halt temporarily during 64% episodes. Explorative behaviours were frequently observed. We recorded 983 sleep-related movements in the healthy controls. Only 8 of them were characterized by head flexion/extension but in the context of a body position change.

Conclusion: We identified 3 specific motor patterns in DoA patients never hitherto reported and not observed in healthy controls. Identification of these patterns could be important for the diagnosis and serve as the basis for a new definition of DoA in adults.

Disclosure: Nothing to disclose

EPR2240

Neurophysiology of parasomniasG. Mayer¹, A. Heidebreder², D. Krefting³¹Department of Neurology, Hephata-Klinik Treysa, Schwalmstadt, Germany; ²Medical University of Innsbruck, Innsbruck, Austria; ³Institut für Medizinische Informatik, Universitätsmedizin Göttingen, Göttingen, Germany**Background and aims:** The pathophysiology of NREM parasomnias is not well understood.

The study aims were to re-investigate in a large sample of patients with NREM parasomnia the consistency of several hypotheses from recent literature: Fragmentation of 1st sleep cycles, delayed built up and decay of slow wave sleep, decrease of slow wave sleep, increase of slow wave activity prior to events, topography of sleepwalking (SW) events, neuronal networks involved in SW, differences in SW events followed by sleep stage vs wake.

Methods: 196 SW (ICSD 2/3 criteria) were compared to 197 from the SIESTA group (110 matches). Sleep staging was performed according to Rechtschaffen & Kales. Time delay stability (TDS) was used to investigate brain connectivity.**Results:** SW had more stage N3, no change in N3 latency, N3 increased with age, N3 phases were less, but longer than in controls. Wake after sleep onset was increased in the 1st sleep cycles, number of awakenings was slightly increased at night, transition from N3-wake was increased, and reduced from stage N3-N2. Transition probabilities showed more change from N2-N3-wake and wake-N2. TDS connectivity showed more elevated link ratios between frontal and central locations and central and occipital locations in SW. TDS connectivity 3 and 6 minutes prior to SW showed a tendency to lower link ratios in the low frequency domain fronto-occipital.**Conclusion:** Our data confirm for SW: higher stability of N3, higher N3 pressure, increased number of awakenings from N3, dissociated connectivity fronto-occipital, increased WASO compared to controls.**Disclosure:** Nothing to disclose

EPR2241

Altered pharmacokinetics of sodium oxybate in narcolepsy type 1 patients after gastric bypass surgeryM. Moresco¹, S. Mohamed¹, A. Perrone¹, F. Pizza², M. Contin¹, R. Riva¹, G. Plazzi²¹IRCCS Istituto delle Scienze Neurologiche, Bologna, Italy;²Department of Biomedical and Neuromotor Sciences, Università di Bologna - Alma Mater Studiorum, Bologna, Italy**Background and aims:** We investigated pharmacokinetics of sodium oxybate (SO; Xyrem®) in 2 narcolepsy type 1 (NT1) patients developing side effects after gastric bypass surgery (enuresis, morning nausea and dizziness).**Methods:** 4 NT1 patients (2 underwent gastric bypass and 2 were controls) on SO stable dose for at least 12 months. Each subject took 2 56mg/kg doses of SO 4 hours apart. SO concentrations were determined from blood samples [1] at 0, 0.75, 1.5, 2, 3, 4 hours following first dose, and at 4.75, 5.5, 6.5, 8, 9 hours after the second.**Results:** Mean (\pm SD) maximum SO (gamma-hydroxybutyric acid) blood concentrations (C_{max}) were 79.4 \pm 7.5 μ g/ml and 44.65.6 μ g/ml after 1st dose; 127.3 \pm 20.2 μ g/ml and 79.3 \pm 0.9 μ g/ml after the 2nd dose for patients with gastric bypass and controls, respectively. Residual morning SO levels at 8 hours from the 1st dose were 58.6 \pm 18.8 μ g/ml in gastric resection patients vs 9.1 \pm 7.3 μ g/ml in controls. Maximum time needed to reach the 1st dose C_{max} was 1.5h in gastric bypass patients and 0.75h in controls. Mean area under the plasma concentration-time curve (AUC_{0-9h}) was doubled in patients with gastric bypass vs controls: 656.6 \pm 18.9 vs 275.7 \pm 31.1 [(μ g/ml) x h] respectively.**Conclusion:** Gastrointestinal alterations particularly impaired gastric emptying and increased intestinal transit time [2], which might result in prolonged exposure of the drug to intestinal mucosa accounting for the higher extent of SO absorption and explaining the occurrence of the side effects observed in our patients with gastric bypass.**Disclosure:** Nothing to disclose

EPR2242

Spectrum of motor manifestations during REM sleep in idiopathic REM sleep behavior disorder

J. Nepozitek¹, C. Unal², S. Dostálová¹, I. Prihodová¹, V. Ibarburu¹, P. Dusek¹, K. Sonka¹

¹Department of Neurology and Center of Clinical Neuroscience, First Faculty of Medicine, Charles University and General University Hospital in Prague, Prague, Czech Republic, ²Ankara University, Faculty of Medicine, Ankara, Turkey

Background and aims: Abnormal motor activity in rapid eye movement (REM) sleep is a major video-polysomnographic (video-PSG) feature of idiopathic REM sleep behavior disorder (iRBD). The diagnosis is based on complex nature of the movements visible at the video recording during video-PSG, but more discreet motor manifestations can be observed as well. The aim was to perform a systematic video analysis of movements during REM sleep.

Methods: Motor manifestations identified at the video during video-PSG in 34 iRBD patients aged 67.5±7.1 years were classified into 4 categories according to clinical severity (elementary, excessive, scenic and violent). In addition, topographic distribution, brief and slow character of movements, association with vocalization, subsequent wakefulness and emotional subtext were determined for each motor event.

Results: An average of 123.8±118.6 motor events were identified in REM sleep. Of these, 67.8% were classified as elementary, 9.1% as excessive, 22.4% as scenic and 0.7% as violent. Violent manifestations were observed in 32.4% of patients. Brief movements were more frequent than slow (p=0.001). Vocalization occurred in 38.2% of patients. Movement caused wakefulness in 8.8% of patients and in 20.6% was at least once associated with distinct emotion.

Conclusion: This study shows extensive variability in a large amount of motor phenomena registered in REM sleep in iRBD. Elementary events represent the vast majority. Although violent manifestations were captured in relative minority, they were detected in 32% of patients.

Disclosure: This work was supported by grants: Charles University grant GAUK 64216, Czech Science Foundation grant GACR 16-07879S and Ministry of Health of the Czech Republic grant 16-28914A.

EPR2243

Rest-wake activity and sleep patterns among patients with acute ischemic stroke

E. Pajediene¹, E. Paulekas¹, K. Petrikonis¹, C.L. Bassetti², D. Rastenyte¹

¹Neurology department, Hospital of Lithuanian university of Health sciences, Kaunas, Lithuania, ²Department of Neurology, Inselspital, Bern University Hospital and University of Bern, Bern, Switzerland, Berne, Switzerland

Background and aims: Non-breathing sleep disorders (non-SBD), which may negatively affect neurological course and recovery after stroke, are common but underinvestigated. The aim of our study was to analyse rest-wake activity and sleep patterns among patients with acute ischemic stroke.

Methods: Patients hospitalized in Hospital of Lithuanian University of Health Sciences within 2-7 days after 1st stroke symptoms were investigated with questionnaires, polysomnography (PSG), actigraphy for rest-wake activity and exposure to light, and thermochrone for body temperature.

Results: We included 27 patients (17 males) with an age median of 67.5 [range: 39÷82] and a NIHSS score of 4 [1÷16], due to a stroke in the anterior (78%) or posterior (22%) circulation. Based on PSG data, 17 (63%) patients were diagnosed with SBD, 7 (25.9%) – with periodic limb movement disorder, and 2 (7.4%) – with insomnia. Actigraphy analysis suggested the presence of an impaired diurnal rhythm in 7 (25.9%) patients, insomnia - 5 (18.5%) and hypersomnia - 13 (48.1%). The average for bed time was 21h: 25min: 34sec [17:40:00÷23:56:54], get up time - 7:01:34 [4:26:45÷11:48:35], total sleep time - 7:34:47 [3:39:00÷11:16:52], sleep efficiency - 77.1% [44.7÷91.79], number of awakenings during night sleep - 42.6 [26.43÷113]. Patients with more severe stroke had a significantly more delayed actigraphy-based sleep onset, worse sleep efficiency and earlier get up time.

Conclusion: Preliminary results of this ongoing study suggest that stroke patients frequently present sleep-wake rhythm disturbances, fragmented and insufficient night-sleep and hypersomnia.

Disclosure: Nothing to disclose

EPR2244

Sleep disturbances and risk of stroke in general population in Russia/Siberia: gender features. WHO epidemiological program Monica-psychosocial

V. Gafarov¹, E. Gromova², D. Panov², I. Gagulin¹,
A. Gafarova¹, E. Krymov², E. Taneeva³

¹*Collaborative Laboratory of Cardiovascular Diseases Epidemiology, Novosibirsk, Russian Federation,* ²*Institute of Internal and Preventive Medicine - branch of Institute of Cytology and Genetics, Novosibirsk, Russian Federation,* ³*GBUZ NSO "State Novosibirsk Regional Clinical Hospital", Novosibirsk, Russian Federation*

Background and aims: There are a few studies describing gender differences a risk of stroke in general population depending on sleep quality. The aim was to determine the gender differences in the effect of sleep disorders on risk of stroke in an open population 25-64 years in Russia/Siberia over 16 years of follow-up.

Methods: Under the 3rd screening of WHO program MONICA -Psychosocial a random representative sample of both gender aged 25-64 years in Novosibirsk was examined in 1994 (n=1346, male 48.8%, mean age 44.9±0.4 years). The sleep assessment was performed using the Jenkins Sleep Questionnaire. There were 35 cases of new-onset stroke in women and 22 in men from 1994 to 2010. This longitudinal survey performed in frame budgetary issue #AAAA-A17-117112850280-2.

Results: In an open population aged 25-64 years 48.6% of men and 65.9% of women had sleep disorders (p<0.001). In univariate analysis risk of stroke was higher in men HR=3 (95%CI 1.2-7.6; p<0.05) than in women HR=1.9 (95%CI 1.03-3.7; p<0.05). Multivariate analysis revealed in men with SD 2.8-fold risk of stroke (95%CI 1.1-7.1; p<0.05) and women HR=2,7 (95%CI 1.4-5.42; p<0.01). Stroke risk was higher in men with lower educational level and SD. There was an increase in the risk of stroke in women with a college education and SD HR=3.7 (95%CI 1.1 - 11.9; p<0.05).

Conclusion: Our results demonstrated men with sleep disorders had higher risk of stroke than women. Social gradient increases cardiovascular risk in urban inhabitants with sleep disorders unequally.

Disclosure: Nothing to disclose

Monday, May 25 2020

Cerebrovascular diseases 5

EPR3001

A Cost-Benefit Analysis of Routinely Performed Transthoracic Echocardiography in the Setting of Acute Ischemic Stroke

J. Rothrock

Neurology, George Washington University, Washington, MD, USA

Background and aims: The role of transthoracic echocardiography (TTE) in the management of acute ischemic stroke remains controversial. This study was undertaken to assess the cost vs benefit of “routine” TTE.

Methods: We examined a consecutive series of patients who were hospitalized for acute ischemic stroke and underwent TTE. We sought to determine the frequency with which the results of TTE led to a new diagnosis of cardioembolism and at least potentially influenced short or long-term clinical outcome. We recorded the direct cost associated with TTE.

Results: There were 1076 patients in the study group, all of whom underwent TTE. TTE identified an unsuspected source of possible/probable cardioembolism in 62 patients (6%), confirmed an initially suspected source (primarily endocarditis) in an additional 13 (1%) and produced findings that stimulated subsequent testing diagnostic of possible/probable cardioembolism in 7 patients (<1%). TTE results potentially influenced clinical outcome in a total of 48 patients (4%). With a total direct cost of \$1.51 million, the mean cost per case wherein TTE results potentially influenced clinical outcome was \$31,375. Diagnostically and therapeutically, TTE was most beneficial in 67 patients under the age of 55 who presented with “cryptogenic” stroke, identifying patent foramen ovale in 21 (31%); closure was performed in 19.

Conclusion: The utility of TTE in the setting of acute ischemic stroke is modest, with its yield greatest in younger patients with cryptogenic stroke. Given the greater sensitivity of transesophageal echocardiography in detecting PFO and evaluating the aortic arch, TTE’s role in stroke diagnosis would appear to be limited.

Disclosure: Nothing to disclose

EPR3002

Factors associated to lobar hemorrhage and death risk after transient focal neurological episodes in cerebral amyloid angiopathy: a systematic review and individual participant data meta-analysis.

J.M. Sanchez-Caro¹, I. De Lorenzo², E. De Celis Ruiz³,

L. Calviere⁴, R. Galiano⁵, A. Barquilla Arribas⁶,

N. Raposo⁷, B. Fuentes², J. Rodríguez-Pardo²

¹Neurology, La Paz University Hospital, Madrid, Spain,

²Neurology, Hospital Universitario La Paz, Madrid, Spain,

³Madrid, Spain, ⁴Centre Hospitalier Universitaire, Toulouse,

France, ⁵Neurology, Dr Peset University Hospital, Valencia,

Spain, ⁶Hospital del Mar, Barcelona, Spain, ⁷TOULOUSE,

France

Background and aims: Transient focal neurological episodes (TFNE) are a frequently overseen presentation of cerebral amyloid angiopathy (CAA) whose prognostic implications are still not well described. This study aims to examine factors associated to further development of lobar hemorrhage (LH) and to death after a first event of TFNE due to CAA.

Methods: Systematic review and individual participant data meta-analysis of TFNE in CAA. 2 systematic searches in Pubmed and Embase were performed. This study was conducted following the PRISMA guidelines.

Results: 49 studies and 231 TFNE cases were included according to predefined inclusion criteria from the initial 1619 records. Motor symptoms were present in 39.4% of TFNE cases. Convexity subarachnoid hemorrhage and cortical superficial siderosis (CSS) were detected in 78.9% and 68% of individuals, respectively. Follow up was performed in 167 patients (median 13 months). LH during follow-up was the most frequent adverse event (41% of patients). Motor symptoms (OR 2.50, IC95% 1.32-4.71) and antithrombotic use during follow-up (OR 3.64, IC95% 1.53-8.64) constituted the main risk factors for LH. A total of 19.3% patients died during follow-up being incident LH during follow-up and CSS the main risk factors for death (OR 2.88, IC95% 1.28-6.48; OR 3.28, IC95% 1.17-9.23, respectively).

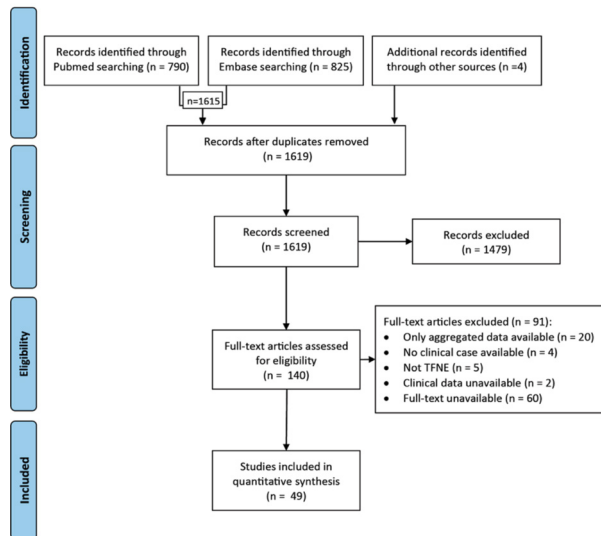

Figure 1. Flow diagram.

Flow Diagram

Conclusion: CAA patients presenting with TFNE are subject to a particularly high risk of morbidity and mortality. Motor symptoms and use of antithrombotics may play a role increasing bleeding risk while CSS and LH act as risk factors for death. These results provide new prognostic information regarding these episodes.

Disclosure: Nothing to disclose

EPR3003

1-year prognosis of transient ischemic attacks with nonfocal symptoms

M. Santos, P. Canhão

Department of Neurosciences and Mental Health, Neurology Hospital de Santa Maria, CHLN, University of Lisbon, Lisbon, Portugal

Background and aims: A few studies suggested an increased risk of stroke or coronary heart disease in patients with transient ischemic attacks (TIA) presenting with accompanying nonfocal symptoms. We aimed to assess the vascular prognosis of TIA patients with and without accompanying nonfocal symptoms.

Methods: Observational study of consecutive patients with TIA referred to a TIA Clinic from March 2004 to March 2011. Primary outcome was the composite of any event: stroke, TIA, myocardial infarction (MI) or vascular death in the 1st year of follow-up; 2ndary outcomes included individual components of the primary outcome. Cumulative risk of recurrent events was calculated using Kaplan-Meier curves. Hazard ratios were calculated with Cox regression.

Results: 429 TIA patients were enrolled, 100 (23.3%) with nonfocal symptoms. Most common nonfocal symptoms were cardiac and vegetative signs, and nonrotatory dizziness. In the 1st year after TIA, the primary outcome occurred in 65 patients (16.0%; 95% CI, 12%-19%): stroke, in 28 patients; TIA, in 31 patients; MI and vascular death in 2 patients each. The frequency of the composite outcome was similar in patients with or without nonfocal symptoms (16 events (17.0%; 95% CI, 10-24%) vs. 49 events (15.7%; 95% CI, 12-20%); $p=0.430$). There were no significant differences in the frequency of any of the secondary outcomes between patients with or without nonfocal symptoms.

Conclusion: Nonfocal symptoms were reported by almost one-fourth of TIA patients, but their occurrence did not increase the risk of vascular events at one year of follow-up.

Disclosure: Nothing to disclose

EPR3004

Association of post-stroke sleep wake disturbances with endothelial dysfunction, arterial stiffening and decreased heart rate variability

I. Filchenko¹, M. Dekkers¹, M. Schmidt¹, C. Bernasconi², C.L. Bassetti¹

¹Department of Neurology, Inselspital, Bern University Hospital and University of Bern, Bern, Switzerland,
²F. Hoffmann-La Roche Ltd, Basel, Switzerland

Background and aims: Sleep-wake disturbances (SWD) and cardiovascular parameters, such as arterial stiffness, endothelial function and heart rate variability (HRV), are known to affect cardio-cerebrovascular risk and outcome. In this study, we investigated the interaction and the temporal development of these factors after acute stroke.

Methods: The Sleep Deficiency & Stroke Outcome Study, prospectively assessed 438 stroke patients recording demographic, anthropometric, stroke and sleep (questionnaires, respirography, actigraphy) characteristics. In a randomly selected subset of 64 patients, EndoPAT-derived cardiovascular features (endothelial dysfunction, arterial stiffness, HRV) were evaluated at admission, 3 and 12 months after stroke.

Results: Using mixed effect linear models adjusted for age, gender and medical and stroke history, different associations between cardiovascular parameters and specific SWD were observed (Figure 1). SWD were prevalently associated with EndoPAT-derived cardiovascular parameters generally accepted as carrying negative cardiovascular prognosis. We observed the association of endothelial dysfunction with fatigue, longer time with oxygen saturation below 90% and longer sleep duration, the association of arterial stiffening with excessive daytime sleepiness and shorter sleep duration and the association of decreased heart rate variability with fatigue, insomnia and restless leg syndrome. Although sleep quality and sleep duration improved after stroke (p=0.032 and p=0.019, respectively), EndoPAT-derived cardiovascular parameters remained constant over time.

Conclusion: These data suggest an association between EndoPAT-derived cardiovascular parameters and specific SWD, which may contribute to the negative relation between SWD and stroke outcome.

Disclosure: Nothing to disclose

Cardiovascular feature	Endothelial function	Arterial stiffness	HRV			
	EndoPAT-derived parameter	Reactive hyperemia index	Augmentation index	Standard deviation of NN intervals	Triangular index	Low to high frequency ratio
Sleep characteristics	Sleep quality (Pittsburgh sleep quality index)	+				
	Fatigue (Fatigue severity scale)	-		-		
	Excessive daytime sleepiness (Epworth Sleepiness Scale)	+	+			
	Insomnia (Insomnia Severity Scale)				-	
	Restless leg syndrome					+
	Oxygen desaturation index					
	Time with oxygen saturation below 90%	-	-			
Demographic parameters	Lowest oxygen saturation	+				-
	Sleep duration	+	-			
Anthropometrics	Age			+	+	-
	Gender			+	+	-
Comorbidities	Body mass index			-	-	+
	Hypertension	-		-	-	
	Atrial Fibrillation	+	+	+		
	Coronary artery diseases			+	+	-
	Previous stroke	-		+	+	-
	Diabetes	+	+	+	+	
	Migraine	-				
	Depression		+			
	Apathy				-	-
	Smoking	-	+		-	-
Stroke characteristics	Stroke or transient ischemic attack	-		+	+	-
	TOAST stroke subtype	+				
	Wake-up stroke	+	+	+		

Figure 1. Associations between EndoPat-derived cardiovascular findings and SWD. Positive and negative significant associations are represented with “+” and with “-“, respectively.

EPR3005

Risk factors for carotid plaque progression

D. Školoudík¹, T. Hrbac¹, D. Netuka², D. Vaclavik³

¹Ostrava, Czech Republic, ²Neurosurgery, Military University Hospital Prague, Prague, Czech Republic, ³Agel Research and Training Institute, Ostrava Vitkovice Hospital, Ostrava, Czech Republic

Background and aims: Carotid plaque progression belongs to factors increasing stroke risk. The aim was to identify factors influencing carotid plaque progression.

Methods: The ANTIQUE study (Clinical Trials NCT02360137) participants completed sonographic controls during 3 years were enrolled to analysis. Duplex sonography of cervical arteries was performed in 6-month intervals with measurement of plaque width in carotids. Plaque width measurement error (ME) was set as 99th percentile of difference between 2 measurements of in 2-week interval. Stable and progressive plaques were defined as plaque width difference between initial and final measurements <1ME and >2ME, resp. Univariate and multivariate logistic regression analysis (LRA) was performed to identify factors (age, gender, body mass index, blood pressure, carotid plaque width, arterial hypertension, diabetes mellitus, coronary heart disease, atrial fibrillation, myocardial infarction, stroke, vascular surgery/stenting, smoking, alcohol use) influencing the plaque progression.

Results: Totally 1391 patients (466 males, age 67.2±9.2 years) were enrolled to the analysis. Stable plaques in both carotids were detected in 332 patients. Progressive plaque in at least 1 carotid artery was detected in 255 patients. Higher age (66.7 vs. 69.5 years), male gender (37.7% vs. 49.4%), greater plaque width (2.61 vs. 3.12mm), coronary heart disease (19.6% vs. 28.6%), vascular surgery/stenting in history (11.1% vs. 22.8%) and smoking (9.9% vs. 17.3%) were more frequently present in patients with progressive plaque (p<0.05 in all cases). Multivariate LRA identified only plaque width (OR=1.850) as the independent factor influencing plaque progression.

Conclusion: Carotid plaque width (corresponding with stenosis severity) is the independent risk factor for plaque progression.

Disclosure: Supported by the Ministry of Health of the Czech Republic grant No. 17-31016A.

EPR3006

CT Scan Reevaluation Prior to Mechanical Thrombectomy in Large Vessel Occlusion Patients Transferred from a Primary Stroke Center: an unneeded safety checkpoint?

J. Sousa¹, L. Santos-Martins², J. Simões³, L. Cruz⁴, H. Rodrigues⁵, C. Duque⁶, L. Almendra¹, C. Nunes⁶, C. Machado¹, B. Rodrigues¹, E. Machado⁷, F. Silva¹, G. Santo¹, J. Sargento-Freitas¹

¹Neurology, Centro Hospitalar e Universitário de Coimbra, Coimbra, Portugal, ²Faculdade de Medicina da Universidade de Coimbra, Coimbra, Portugal, ³Medicina Interna, Centro Hospitalar e Universitário Lisboa Norte, Lisbon, Portugal, ⁴Neuroradiology, CHUC, Coimbra, Portugal, ⁵Centro Hospitalar e Universitário de Coimbra, Coimbra, Portugal, ⁶Coimbra, Portugal, ⁷Neuroradiology, Centro Hospitalar e Universitário de Coimbra, Coimbra, Portugal

Background and aims: The benefit of mechanical thrombectomy (MT) is time-dependent but inadequate selection of patients may lead to futile and riskful recanalizations. In patients transferred from a primary stroke center (PSC) with acute ischemic stroke due to large vessel occlusion (LVO-AIS) it is uncertain whether computed tomography (CT) scan reevaluation in comprehensive stroke center (CSC) is beneficial or harmful. We aimed to compare clinical outcomes of patients submitted to CT scan reevaluation in CSS prior to MT with patients headed directly to the angio-suite.

Methods: We conducted a retrospective study in a prospectively designed cohort of a CSS. We included consecutive patients admitted to our center from 1/1/2016 to 31/12/2018, transferred from a PSC with LVO-AIS. Group differences were assessed by χ^2 or Fisher exact test for categorical variables, Student t test and Mann-Whitney U test for continuous variables as appropriate. We performed a logistic regression to estimate the probability of modified Rankin Scale (mRS) 0-2 according to CT reevaluation.

Results: We included 363 patients. In 66.8% a CT scan was performed before MT. We found no difference between CT or no-CT patients except for hypertension which was higher in CT group (p=0.025). The median door-to-groin time increased from 41 to 106 minutes (p<0.001) from no-CT to CT. Recanalization rate, hemorrhagic transformation and 90-day mRS were similar in both groups (OR:0.881; CI95%:0.557-1.393; p=0.588)

Conclusion: CT scan prior to MT delayed considerably recanalization but no difference was found in both safety and effectiveness outcome measures between groups.

Disclosure: Nothing to disclose

EPR3007

Subacute Blood-Brain Barrier Permeability after an Acute Ischemic Stroke is associated with Good Clinical Outcome

J. Sousa¹, C. Nunes², L. Ferreira¹, F. Silva¹, G. Santo¹, C. Machado¹, B. Rodrigues¹, M. Castelo-Branco³, L. Cunha¹, J. Sargento-Freitas¹

¹Neurology, Centro Hospitalar e Universitário de Coimbra, Coimbra, Portugal, ²Neuroradiology, CHUC, Coimbra, Portugal, ³Instituto de Ciências Nucleares Aplicadas à Saúde, Coimbra, Portugal

Background and aims: The dynamics of blood-brain barrier (BBB) after an acute ischemic stroke (AIS) are multiphasic. An early increase in permeability is associated with edema, hemorrhagic transformation and poor clinical outcomes. Animal models indicate that a later, subacute stage of increased BBB permeability might have a positive effect representing neurovascular remodeling and neoangiogenesis. However, its clinical impact is still uncertain. Our aim was to evaluate the association between BBB permeability at day 7 after an AIS and the patients' clinical outcomes.

Methods: We included consecutive patients with nonlacunar AIS in the territory of a middle cerebral artery with ages ranging from 18 to 80 years. We used modified Rankin Scale score at 3 months as a measure of clinical outcome. Neuroimaging was performed at day 0 and 7 by Magnetic Resonance Imaging, including assessment of BBB permeability in the infarct lesion by dynamic contrast enhancement with quantification of the volume transfer coefficient (K_{trans}). We performed an ordinal regression model between mRS and BBB permeability adjusting for the baseline variables associated with good outcome and including infarct volume as a covariate.

Results: We included 45 patients; mean age 70.0 ± 10.0 years. BBB permeability in the subacute stage showed a nonsignificant reduction in comparison with day 0: K_{trans} : 0.0158 (SD:0.0092) vs. 0.0163 (SD:0.081), $p=0.756$. Permeability of BBB at day 7 was independently associated with improved clinical outcome (OR: 0.897; 95%CI 0.816–0.986; $p=0.025$).

Conclusion: We found subacute BBB permeability to be associated with good clinical outcome.

Disclosure: Nothing to disclose

EPR3008

Correlation between transcranial contrast ultrasound and transesophageal echocardiography in detection of right-to-left cardiac shunt

N. Stojanovski, Z. Markovic, J. Zidverc-Trajković, A. Pavlovic, N. Šternić, M. Mijajlovic
University of Belgrade, School of Medicine, Belgrade, Serbia

Background and aims: Patent foramen ovale (PFO) is the most common type of right-to-left cardiac shunt (RLS) and together with atrial septal aneurysm (ASA) further increases the risk of ischemic stroke. In order to detect RLS we compared sensitivity of contrast transesophageal echocardiography (c-TEE) to sensitivity of contrast-enhanced transcranial Doppler ultrasound (c-TCD). Influence of vascular risk factors was also observed.

Methods: Retrospective cross sectional study included 58 individuals, treated at Neurology Clinic CCS in Belgrade, with positive c-TCD followed by c-TEE examination in patients with transient ischemic attack (TIA) and/or stroke. Intima-media thickness (IMT) and presence of carotid plaques, degree of stenosis, as well as possible deep venous thrombosis (DVT) were obtained via an ultrasound. From patients' medical history we collected the following data: hypertension; diabetes mellitus; dyslipidemia and smoking habits.

Results: c-TEE confirmed RLS detected by c-TCD in 6.9% patients. We found that there exists a correlation between smoking and total number of microembolic signals (MES) without Valsalva maneuver (VM) ($p<0.05$) as well as between presence of DVT (registered in 5.2% patients) and: total number of MES ($r=0.303$, $p<0.05$); number of MES in the right middle cerebral artery ($r=0.293$, $p<0.05$); and number of MES without VM ($r=0.273$, $p<0.05$). Positive correlation was found between number of MES without VM and interatrial septal defects (PFO and ASA) ($r=0.262$, $p<0.05$); the existing RLS ($r=0.303$, $p<0.05$), and between IMT and the time of occurrence of MES ($r=0.334$, $p<0.05$).

Conclusion: c-TCD and c-TEE are complementary methods for RLS detection which represent an important etiological factor of ischemic stroke and TIA in younger patients.

Disclosure: Nothing to disclose

EPR3009

Thrombo-inflammation is a driving force of stroke progression into the penumbra in mice

G. Stoll¹, M. Bieber¹, M. Franke¹, A. Kollikowski², B. Nieswandt³, M. Pham², M. Schuhmann¹

¹Neurology, University Hospital Wuerzburg, Wuerzburg, Germany, ²Neuroradiology, University Hospital Wuerzburg, Wuerzburg, Germany, ³Experimental Biomedicine, University Hospital Wuerzburg, Wuerzburg, Germany

Background and aims: In acute ischemic stroke upon a major cerebral artery occlusion, infarcts rapidly grow from the core into the penumbra before recanalization which encompasses brain tissue that receives residual blood flow from collaterals which eventually fails. The underlying mechanisms are unknown.

Methods: To address underlying mechanisms mice underwent filament occlusion of the middle cerebral artery (MCAO) for up to 4 hours. Infarct development was compared between sham-treated mice, and mice in which the platelet glycoprotein (GP) receptor Ib which facilitated tethering to the vessel wall was blocked. Moreover, Rag1^{-/-} mice lacking immune cells underwent the same procedures. Infarct volumes were measured by TTC-staining.

Results: Blocking of platelet GPIb ameliorated ischemic brain damage under MCA occlusion compared to sham-treated mice at all occlusion times tested (mean infarct volume 45.4mm³ versus 82.5mm³ at 3h). Inhibition of GPIb reduced T-cell infiltration into ischemic brains pointing to thrombo-inflammation as an underlying mechanism. Accordingly, Rag1^{-/-} mice lacking immune cells were similarly protected from infarct progression under occlusion during MCAO (35.3 mm³ versus 73.2 mm³).

Conclusion: As principal finding we show that it is possible to retard infarct progression into the penumbra under MCA occlusion in mice by either blocking platelet GPIb or by immune cell deficiency. Thus similar thrombo-inflammatory processes underlying ischemia/reperfusion injury (Stoll & Nieswandt, Nat Rev Neurol 2019; 15:473-481) are operative already at the hyperacute stroke stage under vessel occlusion. These findings pave the way for novel treatment strategies targeting thrombo-inflammation to salvage the penumbra before recanalization.

Disclosure: Funded by the German Research Foundation project number 374031971 CRC/TR240

EPR3010

Computed Tomographic Perfusion abnormalities in acute migraine with aura: Predictors and differential diagnosis with Transient Ischemic Attacks

D. Strambo¹, S. Nannoni¹, L. Rebordão², V. Dunet³, P. Michel⁴

¹Stroke Center, Clinical Neurosciences, Lausanne University Hospital, Lausanne, Switzerland, ²Lisbon, Portugal, ³Radiology, Lausanne University Hospital, Lausanne, Switzerland, ⁴Lausanne, Switzerland

Background and aims: Migrainous aura (MA) accounts for up to 10% of “stroke mimics” and can present cerebral perfusion abnormalities. We aimed to compare perfusion CT (PCT) findings in acute MA and transient ischemic attacks (TIA).

Methods: We retrospectively studied patients admitted to our hospital between 2002 and 2014 for the suspicion of acute ischemic stroke, undergoing PCT and receiving a final diagnosis of MA. We visually assessed PCTs for the presence and extension of focal hypoperfusion (FHP). We performed a quantitative analysis for mean-transit-time (MTT), time-to-peak (TTP), cerebral blood flow (CBF) and volume (CBV), measured as ratio between the visually hypoperfused region and the healthy side. MA patients with FHP were compared with consecutive TIA patients showing FHP.

Results: Of 47 patients with MA (median age=33 years, 55% females), 16 (34%) displayed FHP. MA patients with FHP, compared to MA patients without FHP, had similar headache and aura features, but less frequently a history of MA (1/16[6.2%] vs. 14/31[45.2%], p=0.010). Compared to 74 TIA patients with FHP (median age=69 years, 43% females), hypoperfusion in MA patients more frequently involved multiple arterial territories or a whole hemisphere and had less pronounced increase in rMTT (1.2 vs. 1.8, p<0.001) and rTTP (1.1 vs. 1.2, p<0.001) and decrease in rCBF (0.8 vs. 0.6, p<0.001). rMTT displayed the best discriminative ability to differentiate MA from TIA (Figure).

ROC curves for different PCT parameters to differentiate migranous aura from TIA

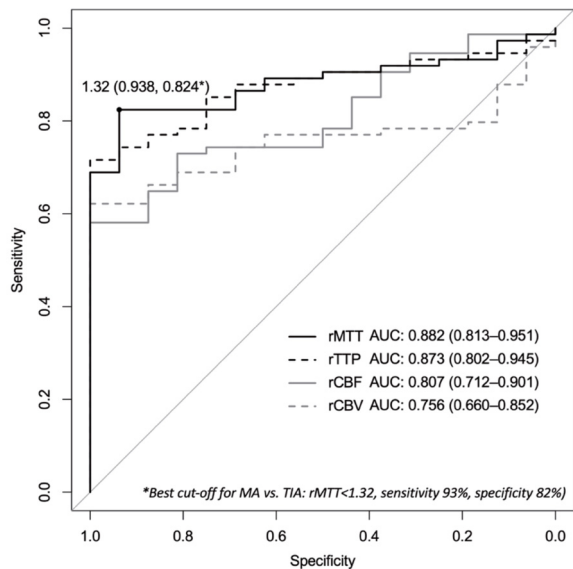

ROC curve analysis for PCT parameters in differentiating MA and TIA

Conclusion: Focal perfusion abnormalities in acute MA often involve multiple unilateral arterial territories and hypoperfusion is less pronounced than in TIA. MA can be best differentiated from TIAs by lesser rMTT increase.

Disclosure: Nothing to disclose

EPR3011

Aphasia after acute stroke in a prospective, randomized, clinical and experimental controlled noninvasive study with an ipad-based app (Neolexon®): study protocol of the Lexi Study

D.C. Thunstedt¹, P. Young², C. Küpper¹, K. Müller¹, R. Becker¹, F. Erbert¹, K. Lehner¹, M. Rheinwald¹, A. Pfahler², M. Dieterich¹, L. Kellert¹, K. Feil¹

¹Neurology, Ludwig Maximilians University (LMU), Munich, Germany, Munich, Germany, ²Department of Neurology, Medicalpark Bad Feilnbach, Munich, Germany

Background and aims: Treatment of aphasia is still challenging for physicians, therapists and patients. So far there is proven evidence for “traditional” logopedic therapy. However, digital age potentially offers the opportunity to work more efficiently and cost-effectively. Neolexon® is a commercial tablet-based software for treatment of aphasia.

Methods: A sample size of 140 patients, 70 for each group will be included. Prospective, randomized, parallel group, open-label, clinical and experimental controlled non-invasive trial. Adult German native speakers suffering from acute aphasia after stroke are included. Computer-generated, blocked and stratified randomization by aphasia severity will assign patients to 1 of 2 groups: either 4 weeks of standard logopedic treatment vs. logopedic treatment with Neolexon® additionally. Both groups will also have self-training. Severity of aphasia will be assessed using the Bielefelder Aphasia Screening (BIAS), Aphasia Bedside Test (AABT) and Aphasia Check List (ACL). Follow-up will be assessed after 3 months.

Results: The primary endpoint is defined as a significant difference between aphasia severity comparing the 2 groups. Differences in quality of life, Beck Depression Inventory (BDI) and modified Ranking Scale (mRS) will be evaluated as secondary outcome parameters.

Conclusion: This trial will determine whether Neolexon® is superior to standard logopedic therapy. Subgroups with the greatest response to Neolexon® will be described.

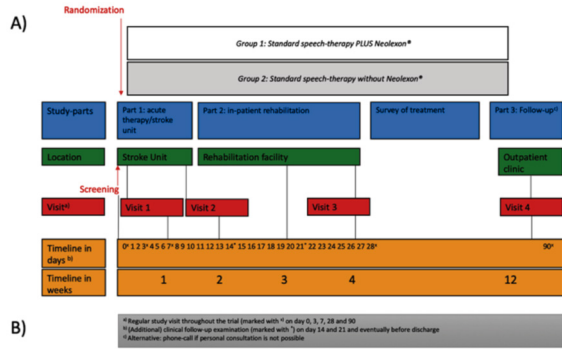

This photo has been approved by Neolexon® for commercial use, publication, distribution, use, editing and transfer - in digital and print form by the photographer or by third parties.

Figure 1

Disclosure: This study is in part funded by Boehringer Ingelheim Pharma GmbH & Co.KG. The funder has no influence on the trial and will not have any impact on participant recruitment, data and statistical analysis or writing the protocol. The company Neolexon® supports the study by granting licenses for the app free of charge. The company also has no influence on the study planning nor the patient treatment and evaluation of the study data.

Cerebrovascular diseases 6

EPR3012

Distribution patterns of dilated perivascular space in moyamoya disease

M.-G. Park¹, J. Rho², S.K. Baik², S.-H. Ahn³, K.-P. Park³
¹Neurology, Pusan National University Yangsan Hospital, Research Institute for Convergence of biomedical science and technology Pusan National University Yangsan Hospital, Yangsan, Korea, Republic of, ²Radiology, Pusan National University Yangsan Hospital, Yangsan, Korea, Republic of, ³Neurology, Pusan National University Yangsan Hospital, Yangsan, Korea, Republic of

Background and aims: The pathogenesis of dilated perivascular space (DPVS) is still unclear. Blood-brain barrier (BBB) dysfunction may be involved in the development of DPVS. BBB dysfunction is also closely related to the pathogenesis of moyamoya disease (MMD). The purpose of this study was to investigate the distribution pattern of DPVS in MMD and to determine whether it is related to cerebral vascular status.

Methods: 51 patients with MMD were included. DPVS were graded in basal ganglia (BG) and centrum semiovale (CS) on T2 weighted imaging, using a validated 4-point semi-quantitative score. Cerebral vascular status on MR angiography (MRA) was graded using a validated MRA scoring. DPVS and MRA grading were classified as high (score >2) or low (score ≤2). Asymmetry of DPVS and MRA grading was defined as a difference of greater than 1 grade between the cerebral hemispheres.

Results: The CS-DPVS was showed in all of the enrolled patients. Out of those, 44 (88%) had high degree of CS-DPVS. The BG-DPVS was showed in 25 (50%), all with low degree of BG-DPVS. The asymmetry of CS-DPVS (26%) and MRA grade (42%) were significantly correlated to each other (Kendall's tau-b 0.604, p<0.001). The CS-DPVS degree was not associated with MRA degree (Kendall's tau-b -0.008, p=0.951) and age (p=0.378).

Conclusion: Our results showed that DPVS in MMD was predominantly observed in the CS and that the asymmetry of DPVS scores between cerebral hemispheres was associated with the asymmetry of the MRA grade.

Disclosure: This study was supported by Research Institute for Convergence of biomedical science and technology Grant (30-2020-015), Pusan National University Yangsan Hospital.

EPR3013

A Cost-Benefit Analysis of Mechanical Thrombectomy Generated Via a “Brain Attack” Protocol

J. Rothrock
 Neurology, George Washington University, Washington, MD, USA

The advent of mechanical thrombectomy for acute ischemic stroke and the corresponding increase in the therapeutic window has produced a paradigm shift in stroke management. While mechanical thrombectomy per se appears to represent a cost-effective treatment intervention, in this study we sought to assess the cost-benefit associated with implementation of a thrombectomy-relevant “brain attack” protocol.

Methods: For a period of 1 year we prospectively evaluated patients treated according to our institution's brain attack protocol. We recorded the frequencies with which RAPID CT perfusion imaging, CT angiography (CTA), catheter-based cerebral arteriography and mechanical thrombectomy were performed and calculated their direct costs. Assuming a number needed to treat (NNT) of 4 to achieve functional independence, we calculated the mean direct cost required to achieve a thrombectomy-related positive clinical outcome.

Results: We evaluated 872 brain attack patients. RAPID CT perfusion imaging and CTA were performed in 384 cases (44%), catheter-based cerebral arteriography in 80 (9%) and mechanical thrombectomy in 48 (5.5%). The direct cost associated with these procedures totaled \$2.186 million. With the NNT of 4 applied to the 48 patients undergoing mechanical thrombectomy, the mean cost of achieving a thrombectomy-related positive outcome was \$182,000.

Conclusion: By ICER criteria, these findings suggest that aggressive use of a thrombectomy-relevant brain attack protocol may represent a borderline cost-effective intervention for acute ischemic stroke. Minimizing the frequency with which CTA that demonstrates no large vessel occlusion is performed or reducing the cost of that procedure would represent the most effective means of improving cost-effectiveness

Disclosure: Nothing to disclose

EPR3014

Anticoagulation treatment in secondary prevention of stroke: the RESTAIC study.

G. Torres Iglesias¹, R. Gutiérrez-Zúñiga¹, M.P.B. Fuentes¹, S. Sanchez Velasco¹, S. Pastor¹, R. Rigual¹, M. Alonso de Leciana², J. Rodríguez Pardo de Donlebún¹, J. Masjuan³, L. Izquierdo Esteban⁴, J.C. Fernandez Ferro⁵, S. Trillo⁶, I. Navas⁷, F.J. Barriga Hernández⁸, E. Diez Tejedor²
¹Neurology, Hospital Universitario La Paz, Madrid, Spain, ²Madrid, Spain, ³Neurology, Hospital Universitario Ramón y Cajal, Madrid, Spain, ⁴Neurology, Hospital Universitario Príncipe de Asturias, Madrid, Spain, ⁵Neurology, Hospital Rey Juan Carlos, Madrid, Spain, ⁶Neurology, Hospital Universitario La Princesa, Madrid, Spain, ⁷Neurology, Fundación Jimenez Díaz, Madrid, Spain, ⁸Neurology, Hospital Universitario Fundación Alcorcón, Madrid, Spain

Background and aims: Our aim is to explore the differences in long-term outcomes according to the type of oral anticoagulant (OAC) in secondary stroke prevention.

Methods: A prospective, multicentric, registry including ischemic stroke patients who were discharged under OAC for secondary prevention of stroke. 3 months follow-up was scheduled at outpatient clinic with subsequent annual phone interviews for 3 years. Principal outcomes: stroke recurrences, intracranial hemorrhage, major bleeding, and mortality. Patients were classified into 3 study groups according to the OAC at discharge: Vitamin K antagonist (VKA), Factor Xa inhibitor (FXa-I) and direct thrombin inhibitor (DTI).

Results: A total of 242 patients with OAC were included and 196 completed the 3-year follow-up evaluation. The reason for OAC treatment was the presence of a cardioembolic source in 241 patients (99.6%). Up to 77 patients (31.8%) were treated with OAC before the index stroke, 62 of them with VKA. At hospital discharge 106 were treated with FXa-I (43.8%), 96 with VKA (39.66%), and 40 with DTI (16.53%). The cumulative incidence at 3 years was 17% for stroke recurrence, 1.6% for intracranial hemorrhage, 4.9% for major hemorrhage and 22% for all-cause mortality; without differences between OAC groups. During the follow-up, 36 patients changed the OAC, mostly for stroke recurrence (12.32% of all causes). No differences among groups were found in OAC changes.

Conclusion: OAC treatment in 2ndary prevention of stroke has a lower risk of bleeding complications than stroke recurrence without differences among the type of OAC.

Disclosure: Nothing to disclose

EPR3015

Predictors of malignant middle cerebral artery infarction after mechanical thrombectomy.

C. Tracol¹, S. Vannier¹, C. Hurel², S. Tuffier², F. Eugene³, P.J. Lereste⁴
¹Neurology, University Hospital Rennes, Rennes, France, ²Epidemiology, University Hospital Rennes, Rennes, France, ³Rennes, France, ⁴Neurosurgery, University Hospital Rennes, Rennes, France

Background and aims: Several predictors have been described to early diagnose malignant middle cerebral artery infarction (MMI) and select patient for hemispherectomy. Nevertheless, few studies have asses them among patients with acute ischemic stroke undergoing mechanical endovascular thrombectomy (MET). The overall objective in this study was to evaluate these predictors in patients undergoing MET in the purpose to guide the medical care in the acute phase.

Methods: We selected patients from a prospective local database which reference all patients eligible for treatment with Alteplase thrombolysis and/or mechanical endovascular thrombectomy in acute stroke. We investigated demographic, clinical, and radiological data. Multivariate regression analysis was used to identify clinical and imaging predictors of MMI.

Results: In 32 months, 66 patients were included. 18 (27.3%) developed MMI. Malignant evolution was associated with: severity of neurological deficit and level of consciousness at admission, infarct size in DWI sequence and involvement of other vascular territories. Study groups didn't differ in terms of successful reperfusion. 2 variables were identified as independent predictors of MMI: DWI infarct volume ($p < 0.001$) and time before recanalization ($p = 0.018$). A decision tree based on these 2 factors was able to predict malignant evolution with high specificity (100%) and sensibility (73%).

Conclusion: Our study proposes a practical decision tree including DWI lesion volume and delay before recanalization to early and accurately predict MMI in a subgroup of patients with MCA infarction undergoing MET regardless to the status of reperfusion.

Disclosure: Nothing to disclose

EPR3016

Predictors of intracranial hemorrhage caused by arteriovenous malformation

A. Tsurkalenko, L. Dziak
Dnipro, Ukraine

Background and aims: Cerebral arteriovenous malformation (AVM) is the most common cause of hemorrhagic stroke in young adults. The role of different factors in the pathophysiology AVM and stroke risk stratification remains unclear. The aim of this study to identify potential biomarkers for AVM stroke risk stratification.

Methods: This observational prospective cohort study included 382 patients with bAVM. Patient's demographics, clinical, neuroimaging data, and angioarchitectural characteristics were analyzed. A univariate analysis was performed, and factors with potential physiological significance that showed at least a trend toward significance were added to a multivariate logistic regression model.

Results: Deep brain location (hazard ratio [HR] 3.25, 95% CI 1.30 to 8.16), high flow AVM (HR 1.05, 95% CI 1.03 to 1.08), single draining vein (HR 1.95, 95% CI 2.01 to 4.15), exclusive deep venous drainage (HR 3.25, 95% CI 1.01 to 5.67), vein stenosis or varices (HR 2.25, 95% CI 1.8 to 3.19), aneurysm on feeding artery (HR 1.01, 95% CI 1.01 to 2.58), occurrence of silent intralesional microhemorrhage (according to neuroradiological assessment) (HR 5.38, 95% CI 2.64 to 10.96) were independent predictors of subsequent hemorrhage. Annual hemorrhage rates on follow-up ranged from 0.8% for patients without determined hemorrhagic risk factors to 39.1% for those harboring all these risk factors.

Conclusion: Knowing the risk factors for hemorrhagic AVM presentation is crucial for selecting appropriate therapeutic strategies. Our results allow to work out design of future trials for optimise management of unruptured AVM. Received information might improve identification of patients at risk.

Disclosure: Nothing to disclose

EPR3017

Influence of new DWI MRI lesions on cognitive functions after carotid endarterectomy

D. Václavík, D. Skoloudik
Ostrava, Czech Republic

Background and aims: Effect of carotid endarterectomy (CEA) on cognitive functions is unclear. The aim was to assess changes in cognitive functions following CEA and influence of new ischemic lesions on diffusion-weighted magnetic resonance imaging (DW-MRI) after CEA.

Methods: Patients without dementia or psychiatric disease including depression were included to the study after signing the Informed consent. In all patients The Addenbrooke's Cognitive Examination-Revised (ACE-R), Mini Mental State (MMSE), Clock Drawing Test (CDT) and Speech Fluency Test (SFT) were performed prior to CEA, 24 hours, 30 days and 1 year after CEA. Demographic data, history of vascular disease, diabetes, smoking, medication, clinical status, new lesion on DWI and changes in cognitive tests were collected and statistically analysed.

Results: Totally 37 (15.0%) out of 247 patients (177 males, age 67.4±7.5 years, 116 symptomatic stenoses) had new ischemic lesions on control DW-MRI. Cognitive tests (median value) in patients with/without DW-MRI lesions prior to CEA, 24 hours, 30 days and 1 year after CEA were: ACER 83/85, 83/90, 87/90, 85,5/90 points; MMSE 27/28, 27/29, 28/29, 27/29 points; CDT 5/5, 5/5, 4/5, 5/5 points; SFT 9/10, 10/10, 10/11, 10/11 points. No significant differences between patients with and without new ischemic lesion were found. Significant improvement was detected in MMSE 24 h after CEA (p=0.011) and CDT 30 days after CEA (p=0.038) compared to results prior to CEA.

Conclusion: New ischemic lesions on DW-MRI after CEA have no influence on cognitive functions in 1-year follow-up.

Disclosure: Supported by the Ministry of Health of the Czech Republic grant No. 17-31016A

EPR3018

A novel mutation in ENG gene in an Italian family with hereditary hemorrhagic telangiectasia and polymicrogyria

D. Villa¹, G. Valcamonica¹, A. Colombi¹, S. Lanfranconi², I. Ghione², D. Ronchi³, G. Manenti⁴, S. Bonato², N. Bresolin³

¹Stroke Unit-Neurology Departement IRCCS Foundation Cà Granda – Ospedale Maggiore Policlinico, Dino Ferrari Centre, Departement of Pathophysiology and Transplantation (DEPT), University of Milan, Milan, Italy,

²Department of Neurology and Stroke Unit, IRCCS Foundation Cà Granda - Ospedale Maggiore Policlinico, Milan, Italy, ³Neurology Departement IRCCS Foundation Cà Granda – Ospedale Maggiore Policlinico, Dino Ferrari Centre, Departement of Pathophysiology and Transplantation (DEPT), University of Milan, Milan, Italy,

⁴Ospedale Maggiore Policlinico, Dino Ferrari Centre, Departement of Pathophysiology and Transplantation (DEPT), University of Milan, Milan, Italy

Background and aims: Hereditary hemorrhagic telangiectasia (HHT) is an autosomal dominant condition primarily caused by mutations in genes involved in the maintenance of the endothelial homeostasis such as Endoglin (ENG).

Main clinical features include recurrent epistaxis, telangiectases and systemic arteriovenous malformations (AVMs). Cortical development malformations have rarely been reported in association with the classical phenotype

Methods: Herein, we describe a case of a 22-years-old-male presenting with sudden onset of slurring of speech and left-sided weakness. He suffered from symptomatic epilepsy and recurrent epistaxis from childhood. Brain MRI showed a right frontal recent ischemic lesion as well as and multiple supratentorial cerebral arteriovenous malformations (cAVMs) and focal polymicrogyria. No atrial septum defects were found despite the evidence of a right to left vascular shunt at transcranial Doppler ultrasound. Chest CT revealed multiple pulmonary AVMs as the obvious source of paradoxical embolism. Given the consistent family medical history and the complex phenotype, genetic testing was performed and revealed a novel heterozygous mutation c.3G>A (p. Met11Ile) in ENG gene, which was likewise found in patient's brother and mother.

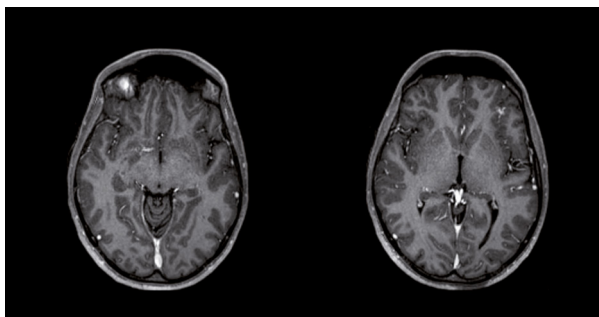

Brain MRI - Axial T1 weighted sequence with gadolinium showing left frontal cAVM and multifocal polymicrogyria involving the left cerebral hemisphere



Pulmonary angiography showing multiple AVMs. A large pulmonary arteriovenous malformation located in the left lower lobe.

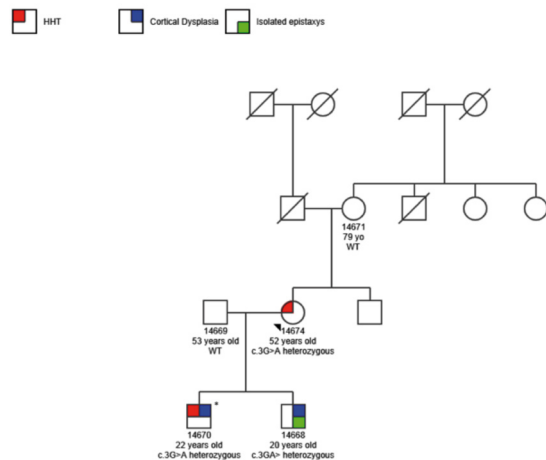

Pedigree. Proband = *. WT = wild type.

Results: The patient underwent endovascular embolization of the largest AVMs and was started on a full dose treatment of low-molecular-weight heparin for six months

Conclusion: We described a novel mutation in ENG gene associated with CAVMs and symptomatic polymicrogyria. If associated with epistaxis, HHT must be ruled out in young patients presenting with acute cerebral ischemic event of unknown origin.

Disclosure: Nothing to disclose

EPR3019

Posterior circulation ischaemic strokes: efficacy, timing and functional outcome of endovascular treatment versus intravenous thrombolysis in a population-based retrospective study.

C. Vincenzi¹, S. Maffei², D. Ferraro³, S. Vallone⁴, L. Vandelli¹, M.L. Dell'acqua¹, L. Picchetto¹, F. Rosafio¹, G.M. Borzi¹, L. Ciolli¹, D. Laterza¹, R. Ricceri¹, M.A. Zini⁵, S. Meletti³, G. Bigliardi¹

¹Stroke Unit, Neurology Unit, Department of Neuroscience, Ospedale Civile S.Agostino-Estense, Modena University Hospital, Modena, Italy, ²Ospedale Civile, Azienda Ospedaliero-Universitaria di Modena, Modena, Italy,

³Department of Biomedical, Metabolic and Neural Sciences, University of Modena, Modena, Italy, ⁴Neuroradiology Unit, Ospedale Civile S.Agostino-Estense, Modena University Hospital, Modena, Italy, ⁵Institute of Neurological Sciences of Bologna IRCSS, Department of Neurology and Stroke Center, Maggiore Hospital, Bologna, Italy

Background and aims: Beyond the Guidelines, few studies proved the efficacy of endovascular treatment (EVT) in posterior circulation ischaemic strokes (PCI) compared to IV thrombolysis (IVT), as well as ideal timing of treatment. To retrospectively compare functional outcomes at 90 days between IVT versus EVT in our population of PCI. To assess predictive factors of good outcome (modified Rankin Scale ≤ 2), favourable outcome (modified Rankin Scale ≤ 3), and mortality.

Methods: From the Italian Registry of Endovascular Treatment and the local database of the Safe Implementation of Thrombolysis in Stroke – International Stroke Thrombolysis Register, 182 patients admitted to our hospital between 2006 and 2019 with posterior circulation vessels' occlusion on neuroimaging were selected: 91 underwent IVT, while 91 EVT (37 IVT plus EVT, 54 direct EVT).

Results: Statistically significant difference in the odds of favourable outcome was found (OR=2.08; 95% CI: 1.04-4.14; P=0.38) in favour of IVT group. On multivariate logistic regression analysis, age and NIHSS at onset were strong independent predictors of either good or favourable outcome (OR=1.05; 95% CI: 1.02-1.08; P=0.000; OR=1.08; 95% CI: 1.05-1.12; P=0.000, respectively); successful recanalization in EVT group (achieved in 76.4%) was shown to be predictive of favourable outcome (OR=2.98; 95% CI: 1.03-3.62; P=0.043). Time to treatment was predictive outcome.

Conclusion: Age, NIHSS at onset and recanalization were predictors of favourable outcome in our population of PCI.

Disclosure: Nothing to disclose

EPR3020

Basilar Artery Occlusion ischaemic strokes: outcomes and predictive factors of intravenous thrombolysis versus endovascular treatment in a population-based retrospective study.

C. Vincenzi¹, S. Maffei², D. Ferraro², L. Vandelli¹, M.L. Dell'acqua¹, L. Picchetto¹, F. Rosafio¹, G.M. Borzi¹, L. Ciolli¹, D. Laterza¹, R. Ricceri¹, S. Vallone³, M.A. Zini⁴, S. Meletti⁵, G. Bigliardi¹

¹Stroke Unit, Neurology Unit, Department of Neuroscience, Ospedale Civile S.Agostino-Estense, Modena University Hospital, Modena, Italy, ²Ospedale Civile, Azienda Ospedaliero-Universitaria di Modena, Modena, Italy,

³Neuroradiology Unit, Ospedale Civile S.Agostino-Estense, Modena University Hospital, Modena, Italy, ⁴Institute of Neurological Sciences of Bologna IRCSS, Department of Neurology and Stroke Center, Maggiore Hospital, Bologna, Italy, ⁵Department of Biomedical, Metabolic and Neural Sciences, University of Modena, Modena, Italy

Background and aims: Pending the results from the BASICS trial, there is no consensus regarding the efficacy of endovascular treatment (EVT) compared to IV thrombolysis (IVT), and the optimal time of treatment, in Basilar Artery Occlusion acute ischaemic strokes (BAOs). To retrospectively compare functional outcomes at 90 days between IVT versus EVT in our population. To assess predictors of good outcome (modified Rankin Scale ≤ 2), favourable outcome (modified Rankin Scale ≤ 3), and mortality.

Methods: From the Italian Registry of Endovascular Treatment and the database of the Safe Implementation of Thrombolysis in Stroke - International Stroke Thrombolysis Register, 82 patients admitted to our hospital between 2006 and 2019 with BAOS on neuroimaging were selected: 23 received IVT, 59 EVT (24 IVT plus EVT, 35 direct EVT).

Results: No statistically significant differences in the odds of good and favourable outcome, as well as mortality, between IVT versus EVT groups were found (OR=8.53; 95% CI: .30-2.41; P=0.764; OR=1.48; 95% CI: 0.56-3.90; P=0.424; OR=1.62; 95% CI: 0.48-5.52; P=0.441, respectively). On multivariate logistic regression analysis, age and NIHSS at onset were strong independent predictors of good and favourable outcome. Successful recanalization in EVT group (achieved in 77.6%) was independent predictor of mortality (OR=40.98, P=0.002), but neither of good nor favourable outcome. Time to treatment was not predictive of any primary outcomes.

Conclusion: Further evidences are needed to clarify the optimal acute management of BAOs.

Disclosure: Nothing to disclose

EPR3021

Development and Validation of 3-month Major Post-stroke Prediction Nomogram after Acute Ischemic Stroke Onset

G. Li, Z. Zhu, S. Zhu

Neurology, Tongji Hospital, Tongji Medical College, Huazhong University of Science and Technology, Wuhan China, China

Background and aims: The early detection of major post-stroke depression (PSD) is essential to optimize patient care. The Post-stroke Depression Prediction Nomogram was needed to develop and validate for early identification of acute ischemic stroke (AIS) patients with increased 3-month major post-stroke depression risk.

Methods: The early detection of major post-stroke depression (PSD) is essential to optimize patient care. The Post-stroke Depression Prediction Nomogram was needed to develop and validate for early identification of acute ischemic stroke (AIS) patients with increased 3-month major post-stroke depression risk.

Results: 11.57% (31/268) patients showed MDD at 3 months after stroke onset. The final logistic regression model included age, NIHSS score on admission, baseline calcium-phosphorus product and serum globulin. The model had acceptable discrimination, based on an C-statistics of 0.80 (95% CI, 0.747~0.846), with 87.10% sensitivity and 61.60% specificity. Furthermore, we transformed the model to nomogram, an easy-to-use risk assessment tool.

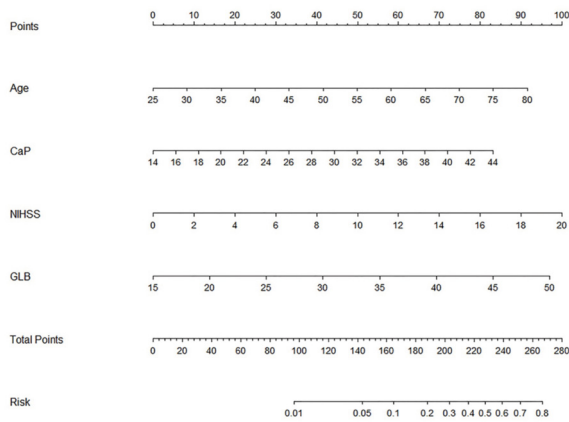
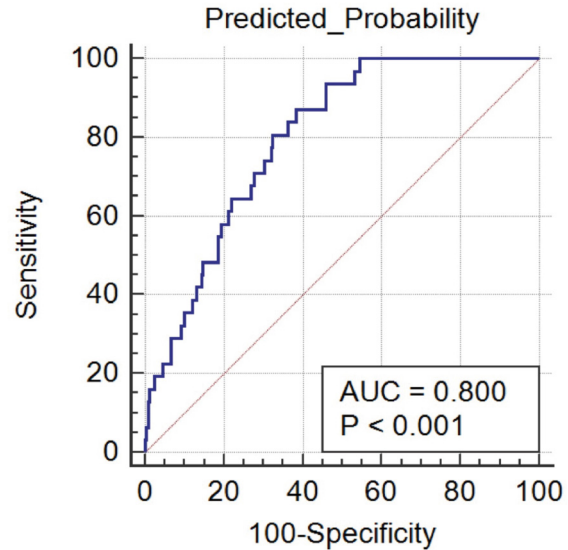
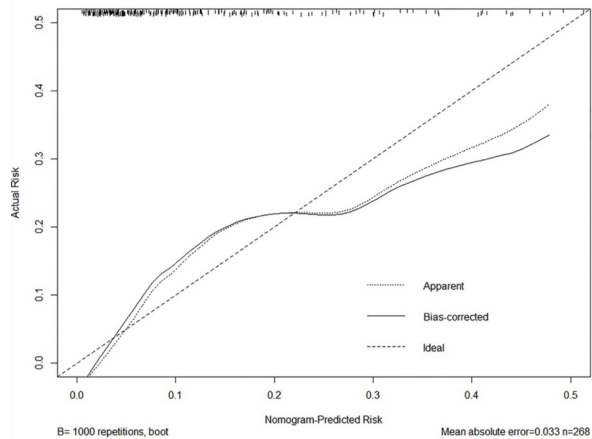

Figure 1. Nomogram to predict the risk of 3-month major PSD after stroke onset



ROC curve was plotted to show the performance of the nomogram. C-statistic was 0.80 (95% CI, 0.747~0.846), with 87.10% sensitivity and 61.60% specificity. Cutoff value was 0.083, which was obtained from the multivariate logistic regression equation with stepwise backwards method.



Calibration plots of the nomogram for major 3-month PSD prediction.

Conclusion: Age, baseline NIHSS score, serum globulin and calcium-phosphorus product were independent predictors of 3-month major PSD. Nomogram, as an effective clinical tool with good predictive performance, facilitate the early assessment of 3-month major PSD risk after stroke onset.

Disclosure: Nothing to disclose

EPR3022

Endovascular thrombectomy in patients with acute ischemic stroke and dementia

E. Zupanic¹, M. Von Euler², B. Norrving³,
M.G. Kramberger⁴, H. Xu⁵, B. Winblad⁶,
M E. Eriksdotter⁷, S. Garcia-Ptacek⁸

¹Ljubljana, Slovenia, ²Örebro University, Faculty of Medicine and Health, Örebro, Sweden, ³Department of Clinical Sciences Lund, Lund University, Skane University Hospital, Lund, Sweden, ⁴The Department of Neurology, University Medical Center Ljubljana, Ljubljana, Slovenia, ⁵Department of Neurobiology, Care Sciences and Society (NVS), Division on Neurogeriatrics, Karolinska Institutet, Huddinge, Sweden, ⁶Dept NVS, Center for Alzheimer Research, SE141 57, Karolinska Institutet, Huddinge, Sweden, ⁷Neurobiology, Care Sciences and Society, Karolinska Institutet, Huddinge, Sweden, ⁸Department of Neurobiology, Care Sciences and Society, Center for Alzheimer research, Division of Clinical Geriatrics, Karolinska Institutet, Huddinge, Sweden

Background and aims: Dementia and stroke are leading causes of disability and dependency worldwide. Numerous studies demonstrated success of endovascular thrombectomy (ET) in acute ischemic stroke (AIS). None of the studies had cognitive impairment or dementia listed as exclusion criteria, however, some studies had an upper age limit (80 or 85 years). Due to intracerebral lesions present in neurodegenerative or vascular cognitive impairment, patients with dementia might have different risks and outcomes after ET. Our aim was to analyze use and outcomes of ET for AIS in patients with pre-existing dementia.

Methods: Nation-wide longitudinal cohort study 2007–2017 from the Swedish national dementia registry (SveDem) and the Swedish national stroke registry (Riksstroke). Patients with dementia who suffered an AIS will be compared with matched non-dementia AIS patients. Access to ET and its outcomes at discharge from hospital and at three months post-stroke (death, residency and modified Rankin Scale score –mRS) will be examined. Odds ratios (ORs) and 95% CI will be calculated using logistic and ordinal logistic regressions.

Results: Final results will be presented at the congress. There were 802 ET of which 43 (5.4%) were performed in patients with dementia. Approximately half of the patients (~400) received intravenous thrombolysis and ET. 20 patients (2.5%) suffered postprocedural brain hemorrhage.

Conclusion: Our hypotheses are that (1) patients with dementia have a worse access to ET, but adjustments for pre-stroke functional independence might explain this difference, and (2) there are no differences in post-procedural intracranial hemorrhages and death, however, patients with dementia have poorer functional outcomes.

Disclosure: Nothing to disclose

Cognitive neurology/neuropsychology 3

EPR3023

Validation of the “Zihlschlacht Planning and Organisation Score” in patients with Parkinson’s disease

K. Stadler¹, J. Ide¹, S. Noelle Stemme¹,
R. Schweinfurther¹, A. Ramirez¹, J. Randerath²,
J.C. Möller¹, A. Binder¹

¹Rehaklinik Zihlschlacht, Zihlschlacht, Switzerland,

²Psychology, Universität Konstanz, Konstanz, Germany

Background and aims: This pilot study examined whether the “Zihlschlacht Planning and Organisation Score” (ZPOS) may represent a valid tool to assess the planning and organisational skills in patients with Parkinson’s disease (PD) with the aim to detect dysexecutive symptoms early in neuropsychological assessment and to avoid confounding with memory deficits in case of poor recall.

Methods: 37 inpatients with PD (22 male, 15 female; age 69.9±8.5 years; disease duration 9.7±6.6 years, Hoehn&Yahr stage 3.0±0.8) performed a neuropsychological assessment including for example the Rey-Osterrieth Complex Figure Test (ROCF) and the planning test as reported by Kohler and Beck (2018). The ZPOS represents a novel approach to evaluate executive function by analyzing with what precision and in what order configurational elements of the ROCF (i.e., the rectangle with 2 centerlines and 2 diagonals) are copied. The ZPOS is calculated by analysing 6 specific items of the copying procedure.

Results: We observed a significant correlation between the ZPOS subscale “precision” containing four items and the planning test ($r=0.49$, $p=0.001$), while correlation with the total ZPOS showed a trend toward significance ($r=0.26$, $p=0.06$). Besides we found a significant correlation between ROCF recall and the total ZPOS ($r=-0.49$, $p=0.001$) and its subscale “precision” ($r=-0.49$, $p<0.001$), respectively.

Conclusion: The ZPOS and the subscale “precision” may feature suitable screening tools for executive function in PD. Besides our results provide further evidence of a possible correlation between executive function and visual memory. Further research is required to delineate the usefulness of the ZPOS in PD and other neurological patients in more detail.

Disclosure: Nothing to disclose

EPR3024

Occupational burnout-like syndrome in early-onset Alzheimer’s disease

P. Olivieri, J. Lagarde, L. Hamelin, C. Roué-Jagot,
M. Sarazin

*Neurology of Memory and Language Unit, GHU Paris
Psychiatrie & Neurosciences, Hôpital Sainte-Anne, Paris,
France*

Background and aims: Early-onset Alzheimer’s disease (EOAD) differentiates from late-onset AD by a predominant and early involvement of the parietal neocortex with hippocampal sparing, leading to non-amnesic syndromes. We aimed to identify the inaugural symptoms leading to a medical consultation in EOAD patients.

Methods: We retrospectively collected the clinical history of patients younger than 62 years referred to our memory clinic for cognitive dysfunction during the last year. Among 91 patients, 31 were diagnosed with AD based on clinical and biological criteria (cerebrospinal fluid biomarkers). Their mean age was 55±3.8 years.

Results: 11 EOAD patients (35%) were initially diagnosed with an occupational burnout syndrome, while logopenic aphasia or visuo-spatial deficit were observed in the remaining 20 patients (65%). In the burnout syndrome subgroup, the delay between the 1st symptoms and neurological examination was 2.6±1.1 years and the initial Mini-Mental State Examination score was 19.6±4.6/30. The neuropsychological assessment showed a severe working memory deficit, associated with mild cognitive cortical parietal syndrome. Visual inspection of brain MRI and FDG-PET showed bilateral parietal atrophy and a severe focal hypometabolism of associative parietal cortices.

Conclusion: We describe for the 1st time a new clinical presentation of EOAD mimicking an occupational burnout syndrome. The severe inaugural working memory deficit due to early cortical parietal damage leads to an inability to carry out concurrent professional tasks, and to severe anxiety, in the absence of overt aphasia or episodic memory deficit. It is crucial to consider this clinical phenotype in the definition of EOAD to avoid delayed diagnosis.

Disclosure: Nothing to disclose

EPR3025

Psychiatric and cognitive features of psychogenic non epileptic seizures and psychogenic neurological deficits

S. Marsli¹, E.B. Rouissi², S. Bellakhdar², M.A. Rafai², B. El Moutawakil³, H. Otmani²

¹Casablanca, Morocco, ²Neurology, CHU Ibn Rochd, Casablanca, Morocco, ³Neurology, Ibn Rochd University Hospital, Casablanca, Morocco

Background and aims: The psychological mechanisms underlying psychogenic neurological impairments or seizures are poorly understood with a lack of well-established evidence-based treatments. The goal of this study is to assess the psychological profile of patients with psychogenic non-epileptic seizures and neurological deficits, and explore their cognition.

Methods: Prospective study including patients with a confirmed psychogenic non-epileptic seizure or psychogenic neurological deficit, recruited from neurology emergencies of Ibn Rochd University Hospital. Psychological assessment was performed by Hamilton scale of anxiety and depression (mild score if <17, moderate when 18-24, and severe when 25-30). MoCA was used for cognitive evaluation. Statistical methods included multivariate analysis with non-parametric regression and fisher's exact test.

Results: Among 27 patients, mid-age was 37.6 years (18-62), 70% were women. 37% had a psychogenic non-epileptic seizure and 63% a psychogenic neurological deficit. In the 1st group, Hamilton anxiety scale mean score was 29 versus 22 for depression. In the 2nd group, Hamilton anxiety scale mean score was 27 versus 20 for depression. 75% of all patients had a severe anxiety (without significant difference between the 2 groups). 50% of the psychogenic deficit patients had a severe depression versus only 25% of patients in the psychogenic non-epileptic seizure patients (p=0.02). MoCA mean score was 22.8, with no significant difference between both groups.

Conclusion: Anxiety seems to be the most predominant psychiatric impairment for our patients with an impact on some cognitive functions (memory, attention). These findings should enable us to wellknow our patients' difficulties and offer them the accurate therapeutic care.

Disclosure: Nothing to disclose

EPR3026

Neuropsychological indicators of subjective cognitive decline progression

A. Perron, M. Roussel, S. Wannepain-Despretz, M. Barbay, A. Devendeville, M.P.O. Godefroy, D. Andriuta

Neurology, Amiens University Hospital, Amiens, France

Background and aims: Neuropsychological indicators to identify cases of subjective cognitive decline (SCD) exist but their discriminant values are still unknown. Our objective was to examine early neuropsychological indicators that could discriminate between people in whom SCD progressed to mild or major neurocognitive disorder (NCD) and people in whom SCD remained stable.

Methods: We retrospectively included patients from the memory center at Amiens University Medical Center with SCD and who had undergone 3 or more neuropsychological assessments at least 6 months apart. The relationship between changes in domain-specific scores and global cognitive score (GCS), as a function of final status was examined using a generalized linear mixed model.

Study participants, n	80
Gender, male, n (%)	34 (42.5)
Age, mean [95%CI]	64.07 [61.68 – 66.47]
MMSE score, mean [95%CI]	28.22 [27.78 – 28.65]
Time between visits 1 and 3, day, mean [95%CI]	1413.1 [1266.984 – 1559.29]
Educational level	
Primary education, n (%)	15 (18.8%)
Secondary education, n (%)	32 (40%)
Tertiary education, n (%)	33 (41.3%)

Abbreviation: CI: Confidence interval; MMSE: Mini-Mental State Examination.

Characteristics of the study population.

Results: Among the 80 patients with SCD, 11 had progressed to a NCD. When considering the GCS, the effect of final status was significant as a result of the lower score measured at the initial assessment. The combination of age, memory (sum of total recall), and action speed scores at the first assessment predicted the progression of SCD with a sensitivity of 91%, a specificity of 78%, a negative predictive value of 98% and a positive predictive value of 40%.

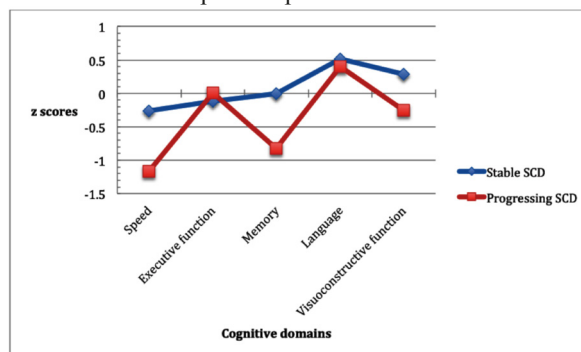

Differences in cognitive domain z scores between “stable SCD” and “progressing SCD” groups of patients.

Conclusion: The present results should help physicians to identify cases of SCD at risk of progression by examining early neuropsychological indicators.

Disclosure: Nothing to disclose

EPR3027

Sensitivity and Specificity of the ECAS in Parkinson's Disease and Huntington's Diseases

B. Poletti¹, L. Carelli¹, F. Solca², S. Torre¹, A. Brugnera³, F. Mancini¹, S. Tagini¹, S. Migliore⁴, S. Maffi⁴, M.T. Moscato⁵, J. Pasquini², F. Squitieri⁴, J. Sassone⁶, A. Ciammola¹, V. Silani⁷

¹Department of Neurology and Laboratory of Neuroscience, IRCCS Istituto Auxologico Italiano, Milan, Italy,

²Department of Pathophysiology and Transplantation, "Dino Ferrari" Center, University of Milan, Milan, Italy,

³Department of Human and Social Sciences, University of Bergamo, Bergamo, Italy, ⁴Huntington and Rare Diseases Unit, Fondazione IRCCS Casa Sollievo Della Sofferenza Research Hospital, San Giovanni Rotondo, Italy,

⁵Fondazione Lega Italiana Ricerca Huntington, Rome, Italy,

⁶Division of Neuroscience San Raffaele Scientific Institute, Vita-Salute San Raffaele University, Milan, Italy,

⁷Department of Pathophysiology and Transplantation, "Dino Ferrari" Center, University of Milan, Department of Neurology and Laboratory of Neuroscience - IRCCS Istituto Auxologico Italiano, Milan, Italy

Background and aims: The study aims to investigate psychometric properties of the ECAS, recently validated in the Italian language, in Parkinson's (PD) and Huntington's (HD) diseases. In particular, the sensitivity and specificity of the ECAS in highlighting HD and PD cognitive-behavioural features and in differentiating between these two populations and from healthy controls (HC) were evaluated.

Methods: Participants were administered the ECAS, together with other cognitive screening tools (FAB, MoCA, RME) and psychological questionnaires (BDI, STAI/Y, I-DAS). Patients' possible changes in behaviour were evaluated by carers interview (ECAS Carer Interview). 73 PD, 38 HD patients and 49 HC were recruited at the San Luca Hospital, IRCCS Istituto Auxologico Italiano and at CSS-Mendel and LIRH Foundation site, Rome. Correlations between the ECAS and traditional cognitive measures, together with core clinical features were analysed.

Results: The ECAS distinguished between HD patients and HC ($p < 0.001$) and between the 2 clinical syndromes ($p < 0.001$) with high sensitivity and specificity. Even if diagnostic accuracy of the ECAS in distinguishing between PD and HC was very low ($p = 0.05$), the PD cognitive phenotype was very well described by the ECAS. Convergent validity of the ECAS against other traditional cognitive screening was observed, as well as correlations with psychological aspects and typical clinical features, especially for the HD group.

Conclusion: The ECAS represents a rapid, feasible and sensitive tool, useful also in different neurodegenerative disorders affecting verbal-motor abilities other than ALS. Clinical applications in these neurodegenerative conditions require further investigations.

Disclosure: Nothing to disclose

EPR3028

The brain mechanisms for the use of objects

E. Rounis
Oxford,

Background and aims: We described new paradigms developed to elucidate the brain mechanisms that are involved in object manipulation to establish whether changes in goal-directed and habitual actions in healthy volunteers and patients with limb apraxia.

Methods: In a novel experiment I developed (Rounis et al. 2017, Figure 1), participants grasped a cup from its open or closed end to lift or turn it. We measured reaction times and error rates when a group of 18 healthy volunteers, and 22 patients with limb apraxia.

In a follow-up experiment (Rounis et al. in preparation, Figure 2) 25 healthy participants performed the same task while being scanned with fMRI.

Conclusion: These results are consistent with the evidence that there is a circuit that is involved in grasping (AIP-PMv) (Murata 2000) and a circuit that is involved in the movement of the object, that is in object use (IP – inferior frontal gyrus) (Fogassi 2009).

Disclosure: Nothing to disclose

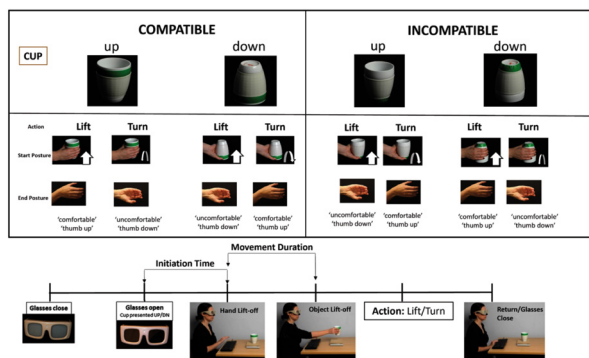

Figure 1 Behavioural Study

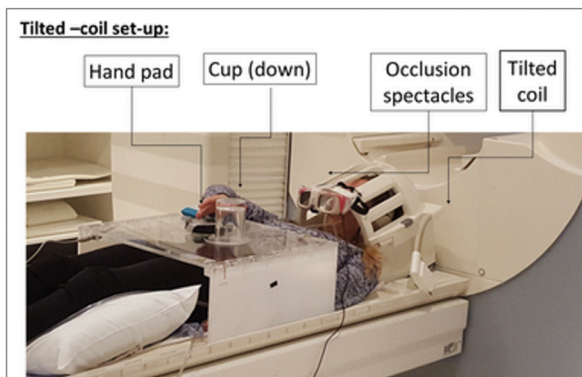

Figure 2 fMRI study

Results: We found that the movements were quicker if the cup was to be grasped by the open (wide) rather than the closed (narrow) end, consistent with the notion that objects ‘afford’ particular actions: a cup is for drinking, hence a preference for its open end. Patients were compromised in non-afforded actions. We identified activations in left anterior intraparietal, and superior temporal areas and in the dorsal premotor area (in incongruent tasks).

EPR3029

The role of executive cognition in the prediction of HIV medication adherence

E. Konstantinopoulou¹, N. Smyrni², E. Aretouli¹, S. Kitmeridou², D. Parisis², N. Grigoriadis², G. Kiosseoglou¹, P. Ioannidis²

¹*School of Psychology, Laboratory of Cognitive Neuroscience, Aristotle University of Thessaloniki, Greece, Thessaloniki, Greece,* ²*2nd Department of Neurology, AHEPA University Hospital, Thessaloniki, Greece*

Background and aims: Suboptimal medication adherence in HIV infection is associated to drug-resistant strain development and viral replication. The aim of the present study is to explore whether neuropsychological tests of Executive Functions predict antiretroviral adherence among HIV individuals beyond and above demographic variables, disease characteristics, motor and overall cognitive functioning.

Methods: 105 HIV-positive individuals completed a comprehensive executive function test battery, along with measures of verbal memory, motor functioning, processing speed, visuospatial perception, picture naming and overall cognitive performance. Medication adherence was assessed via a visual analogue self-report scale recording the amount of prescribed doses taken during the past month. A stepwise linear regression was conducted to examine the ability of executive test performance to predict medication adherence. Subsequently, executive test variables were entered at the final step of a hierarchical regression model in order to assess their additional predictive power on medication adherence.

Results: Performance on two executive cognition measures was associated with medication adherence, explaining 16.2% of the variance. In the hierarchical regression model, 20.1% of the variance in medication adherence reports was explained by treatment complexity, memory performance, age and education, whereas the addition of executive performance added unique variance, increasing the amount of variance explained through the model to 30.3%.

Conclusion: Evaluation of executive functioning suggests a promising tool in order to increase the predictive ability of medication adherence among HIV-positive individuals.

Disclosure: Greek State Scholarship Foundation (I.K.Y.)

EPR3030

Subjective perception of driving ability in patients with Mild Cognitive Impairment (MCI) and mild Alzheimer's Disease (AD)

P. Stamatelos¹, P. Hatzaki¹, I. Beratis¹, D. Pavlou², S. Fragkiadaki¹, D. Kontaxopoulou¹, A. Economou³, L. Stefanis⁴, G. Yannis², S.G. Papageorgiou¹

¹*2nd Department of Neurology, National and Kapodistrian University of Athens, Athens, Greece,* ²*School of Civil Engineering, Department of Transportation Planning and Engineering, National Technical University of Athens, Athens, Greece,* ³*Department of Psychology, National and Kapodistrian University of Athens, Athens, Greece,* ⁴*1st Department of Neurology, National and Kapodistrian University of Athens, Athens, Greece*

Background and aims: Driving ability of patients with neurodegenerative diseases interferes with their everyday functionality and is subjected to neurological evaluation. We examined the self perception of patients with MCI or mild AD regarding their driving ability and their driving habits through a specially developed questionnaire.

Methods: We examined the answers of 40 patients with MCI (27 Males, Mean Age 67-year-old), 14 patients with AD (14 Males, Mean Age 74-year-old) and 63 cognitively healthy individuals (33 Males, Mean Age 48-year-old). Questions referred to driving skills, driving ability and driving habits under difficult conditions.

Results: Both MCI and AD patients recognize increased difficulties (compared to the control group, after controlling for confounding factors) during the last 5 years in driving under certain conditions (night, rain, unfamiliar routes, highways, long distances). AD patients avoid driving under the above-mentioned conditions compared to healthy individuals. However, driving frequency under these conditions does not differ between the MCI patients and the control group. No statistically significant differences were found regarding the subjective evaluation of driving skills between the patients and the control group.

Conclusion: Although, cognitively impaired patients do not recognize impairment of their driving skills, they do realize their difficulties under difficult conditions. Thus, AD patients avoid driving under these conditions, as a compensatory mechanism. This finding is important and highlights the need of objective evaluation of driving ability of patients with (even mild) cognitive impairment along with the utility of targeted questionnaires.

Disclosure: This study is part of the PhD project with title "Evaluation of driving behavior in patients with MCI, Dementia or Parkinson's Disease: Diagnostic and Prognostic Markers", funded and supported by Onassis Foundation.

EPR3031

Cognitive Impairment in Multiple Sclerosis: A Multiparametric Structural and Functional MRI Study

C. Vizzino, G.C. Riccitelli, E. Pagani, P. Valsasina, P. Preziosa, O. Marchesi, M. Filippi, M.A. Rocca
Neuroimaging Research Unit, Institute of Experimental Neurology, Division of Neuroscience, IRCCS San Raffaele Scientific Institute, Milan, Italy

Background and aims: We applied a multiparametric MRI approach to investigate the association between cognitive impairment in multiple sclerosis (MS) patients and specific patterns of structural and functional MRI abnormalities.

Methods: 100 healthy subjects (HC) and 297 MS patients underwent 3D T1-weighted, diffusion tensor, dual-echo and resting-state (RS) scans at 3.0 Tesla. Patients also underwent a neuropsychological evaluation. Grey matter (GM) atrophy, white matter (WM) microstructural abnormalities and RS functional connectivity (RS-FC) of the default mode network (DMN) were investigated using voxel-wise approaches.

Results: 89 MS patients were cognitively impaired (CI). Compared to HC, cognitively preserved (CP) patients had significant GM atrophy of deep GM nuclei, in regions of fronto-temporo-parietal and occipital lobes, cingulate cortex, and hippocampus, bilaterally. Additional widespread GM atrophy in supratentorial regions and cerebellum were found in CI patients. Compared to CP, CI patients had atrophy in the thalamus, caudate nucleus, hippocampus, cerebellum, bilaterally and left supplementary motor area (SMA). Compared to HC, CP patients had decreased fractional anisotropy (FA) of supratentorial WM tracts, while CI patients had additional decreased FA of infratentorial WM tracts. Compared to HC, CP patients had reduced RS-FC in left SMA. CI patients had additional reduced RS-FC in left posterior and middle cingulate cortex, right inferior parietal lobule (IPL) and increased RS-FC in left IPL and right middle frontal gyrus. Compared to CP, CI patients had reduced RS-FC in the left posterior cingulate cortex and right IPL.

Conclusion: Structural abnormalities of critical CNS structures combined with functional maladaptive mechanisms contribute to explain CI in MS patients.

Disclosure: Nothing to disclose

EPR3032

Comparison of longitudinal changes of cerebral small vessel disease markers and cognitive function between subcortical vascular mild cognitive impairment with and without NOTCH3 mutation: a 5-year follow-up study.

C. Yoon¹, S.W. Seo²

¹Neurology, Inha University School of Medicine, Incheon, Korea, Republic of, ²Neurology, Samsung Medical Center, Seoul, Korea, Republic of

Background and aims: In this study, we compared the longitudinal changes in cognition and cerebral small vessel disease (CSVD) markers between subcortical vascular mild cognitive impairment (svMCI) patients with and without NOTCH3 mutation [NOTCH3(+) svMCI vs. NOTCH3(-) svMCI].

Methods: We prospectively recruited patients with svMCI between September 2008 and September 2011 and screened for NOTCH3 mutation by sequence analysis for mutational hotspots in the NOTCH3 gene. Patients were annually evaluated for 5 years.

Results: Among 63 svMCI patients, 9 (14.3%) patients had either known mutations or possible pathogenic variants. Thirteen of 63 patients converted to dementia on follow-up; 1/9 (11.1%) among NOTCH3 (+) svMCI patients and 12/54 (22.2%) among NOTCH3(-) svMCI patients. Cox regression model showed that dementia risk was not significantly different between NOTCH3(+) and NOTCH3 (-) svMCI patients after controlling for age, sex, education, and PiB positivity ($p=0.763$; adjusted hazard ratio, 0.723; 95% confidence interval, 0.088–5.926). Linear mixed effect models testing the interaction effect of NOTCH3 mutation and time showed that NOTCH3 (+) svMCI group had much greater increases in the number of microbleeds [β (SE)=0.66 (0.29), $p=0.025$] and lacunes [β (SE)=0.42 (0.16), $p=0.008$].

Conclusion: The rate of increases in microbleed and lacune counts was much greater in NOTCH3 (+) svMCI patients compared to NOTCH3 (-) svMCI patients. In spite of a much greater increase of lacune and microbleed counts in NOTCH3 (+) svMCI patients, there were no significant differences in dementia conversion rate and neuropsychological score changes over 5 years between the 2 groups.

Disclosure: Nothing to disclose

Epilepsy 3

EPR3033

Long-Term Safety and Efficacy of Cannabidiol (CBD) Treatment in Dravet Syndrome: Results Overall and for Patients Completing 1–3 Years of an Open-Label Extension (GWPCARE5)

R. Nabbout¹, R. Sanchez-Carpintero², J.J. Halford³, Y. Shiloh-Malawsky⁴, I.E. Scheffer⁵, M. Wong⁶, D. Checketts⁷, E. Dunayevich⁸

¹Necker-Enfants Malades Hospital, Paris, France, ²Clinica Universidad de Navarra, Madrid, Spain, ³Medical University of South Carolina, Charleston, USA, ⁴University of North Carolina School of Medicine, Chapel Hill, USA, ⁵University of Melbourne, Austin Health and The Royal Children's Hospital, Melbourne, Australia, ⁶Wake Forest Baptist Medical Center, Winston-Salem, USA, ⁷GW Research Ltd, Cambridge, USA, ⁸Greenwich Biosciences, Inc., Carlsbad, USA

Background and aims: We assessed the long-term safety and efficacy of add-on CBD in patients with Dravet syndrome (DS) in the 3rd interim analysis of the open-label extension (OLE; GWPCARE5; NCT0224573) of two randomised controlled trials (RCTs; GWPCARE1 [parts A/B], GWPCARE2).

Methods: Patients who completed either RCT could enter this OLE, in which they received plant-derived highly purified CBD medicine (Epidyolex[®]; 100mg/mL oral solution). Primary endpoint: safety (n=315). 2ndary endpoints: median percentage change from baseline in convulsive and total seizure frequency overall (n=287) and patients completing 1, 2, and 3 years (n=214, 113, and 55). **Results:** 95% (315/330) of eligible patients with DS enrolled. Median follow-up was 61 weeks (18 days–184 weeks); Mean age was 10 years; 97% <18 years; 50% male. Patients were taking a median 3 concomitant antiepileptic drugs at baseline; 68% were on clobazam, 67% valproate, and 38% stiripentol. Mean modal CBD dose was 22mg/kg/day overall and ranged from 21–24mg/kg/day over follow-up for 3-year completers. 43% (135/315) of patients withdrew. Adverse events (AEs) occurred in 97% of patients and serious AEs in 41%; 9% discontinued due to AEs. Aspartate/alanine aminotransferase levels >3× upper-limit-of normal occurred in 21%. There were 4 deaths; none deemed treatment-related by the investigator(s). Median percentage reduction in convulsive seizure frequency during 12 week visit windows over 156 weeks was 45–73% overall; and 49–56%, 57–67%, and 57–77% for 1-, 2-, and 3-year completers.

Conclusion: Long-term treatment with add-on CBD in patients with DS produced sustained seizure reductions, with no new safety concerns.

Disclosure: This trial was sponsored by GW Pharmaceuticals.

EPR3034

Long-Term Effects of Concomitant Anti-Seizure Medications (ASMs) During Adjunctive Perampanel Treatment in Paediatric Patients (Aged 4-

A. Fogarasi¹, A. Patten², L.Y. Ngo³

¹Epilepsy Center, Bethesda Children's Hospital, Budapest, Hungary, ²Eisai Ltd., Hatfield, Hertfordshire, United Kingdom, ³Eisai Inc., Woodcliff Lake, NJ, USA

Background and aims: We report a post hoc analysis of long-term (1-year) perampanel safety and efficacy by concomitant ASM use in paediatric patients (aged 4–<12 years) with partial-onset seizures (POS; with/without secondarily generalised seizures [SGS]) or primary generalised tonic-clonic seizures (PGTCS) from Study 311 (NCT02849626).

Methods: Cumulative data from all enrolled patients were included (23 weeks [Core Study]; 52 weeks [Core/Extension]). Treatment-emergent adverse events (TEAEs) and efficacy (median percent reduction in seizure frequency/28 days; 50% responder rates) were assessed.

Results: Of 180 patients, 35 (19.4%), 100 (55.6%) and 45 (25.0%) received 1, 2 or 3 baseline ASMs, respectively. Most common concomitant ASMs were levetiracetam (32.2%), valproic acid (30.0%), clobazam (26.7%), lamotrigine (25.0%), topiramate (16.1%) and carbamazepine (13.9%); patients could receive >1 of these. TEAEs are presented in Table 1. Median percent reductions in seizure frequency/28 days are shown in Figures 1/2. At Weeks 40–52, POS, SGS and PGTCS 50% responder rates were: 1 ASM, 78.9% (15/19), 87.5% (7/8) and 75.0% (3/4); 2 ASMs, 63.3% (38/60), 81.8% (18/22) and 66.7% (4/6); 3 ASMs, 48.3% (14/29), 72.7% (8/11) and 33.3% (1/3), respectively. For the most common ASMs, 50% responder rates at Weeks 40–52 ranged from: POS, 50.0% (topiramate [8/16]; valproic acid [18/36]) to 64.5% (levetiracetam [20/31]); SGS, 63.6% (lamotrigine [7/11]) to 100.0% (carbamazepine [4/4]); PGTCS, 0.0% (carbamazepine [0/0]) to 100.0% (valproic acid [3/3]).

Table 1. Overview of TEAEs and most common TEAEs (occurring in ≥15% of patients in any ASM group) by number and most common concomitant baseline ASMs (Safety Analysis Set)

n (%)	Number of baseline ASMs			Most common baseline ASMs					
	One (n=35)	Two (n=100)	Three (n=45)	Levetiracetam (n=58)	Valproic acid (n=54)	Clobazam (n=48)	Lamotrigine (n=45)	Topiramate (n=29)	Carbamazepine (n=25)
Any TEAE	33 (94.3)	89 (89.0)	40 (88.9)	55 (94.8)	47 (87.0)	41 (85.4)	40 (88.9)	25 (86.2)	20 (80.0)
Serious TEAEs	4 (11.4)	16 (16.0)	16 (35.6)	12 (20.7)	13 (24.1)	11 (22.9)	9 (20.0)	7 (24.1)	3 (12.0)
TEAEs leading to discontinuation	4 (11.4)	13 (13.0)	5 (11.1)	8 (13.8)	7 (13.0)	3 (6.3)	6 (13.3)	4 (13.8)	1 (4.0)
Most common (≥15%) TEAEs									
Somnolence	9 (25.7)	26 (26.0)	14 (31.1)	14 (24.1)	17 (31.5)	19 (39.6)	12 (26.7)	5 (17.2)	4 (16.0)
Nasopharyngitis	7 (20.0)	18 (18.0)	18 (40.0)	15 (25.9)	10 (18.5)	17 (35.4)	8 (17.8)	6 (20.7)	6 (24.0)
Dizziness	4 (11.4)	14 (14.0)	6 (13.3)	9 (15.5)	11 (20.4)	4 (8.3)	9 (20.0)	2 (6.9)	5 (20.0)
Pyrexia	8 (22.9)	13 (13.0)	8 (17.8)	9 (15.5)	7 (13.0)	9 (18.8)	7 (15.6)	1 (3.4)	5 (20.0)
Vomiting	8 (22.9)	15 (15.0)	4 (8.9)	11 (19.0)	7 (13.0)	5 (10.4)	5 (11.1)	1 (3.4)	5 (20.0)
Irritability	7 (20.0)	10 (10.0)	7 (15.6)	8 (13.8)	8 (14.8)	2 (4.2)	7 (15.6)	4 (13.8)	1 (4.0)
Influenza	5 (14.3)	10 (10.0)	8 (17.8)	7 (12.1)	7 (13.0)	6 (12.5)	8 (17.8)	5 (17.2)	6 (24.0)
Headache	4 (11.4)	5 (5.0)	6 (13.3)	9 (15.5)	2 (3.7)	3 (6.3)	7 (15.6)	0 (0.0)	2 (8.0)
Balance disorders	0 (0.0)	4 (4.0)	3 (6.7)	3 (5.2)	2 (3.7)	1 (2.1)	0 (0.0)	5 (17.2)	0 (0.0)

A TEAE is defined as an AE that emerges from the date of first dose of study drug to 28 days after the last end date of dose in prescribed dose entity, having been absent at pretreatment or recurred during treatment, having been present at pretreatment but stopped before treatment, or worsened in severity during treatment relative to the pretreatment state, when the AE is continuous.

Patients with ≥2 TEAEs in the same system organ class or with the same preferred term are counted only once for that system organ class or preferred term.

AE, adverse event; ASM, anti-seizure medication; TEAE, treatment-emergent adverse event.

Table 1. Overview of TEAEs and most common TEAEs (occurring in ≥15% of patients in any ASM group) by number and most common concomitant baseline ASMs (Safety Analysis Set)

Figure 1. Median percent reduction in seizure frequency per 28 days from baseline by number of baseline ASMs for (A) POS*, (B) SGS* and (C) PGTCs (Full Analysis Set)

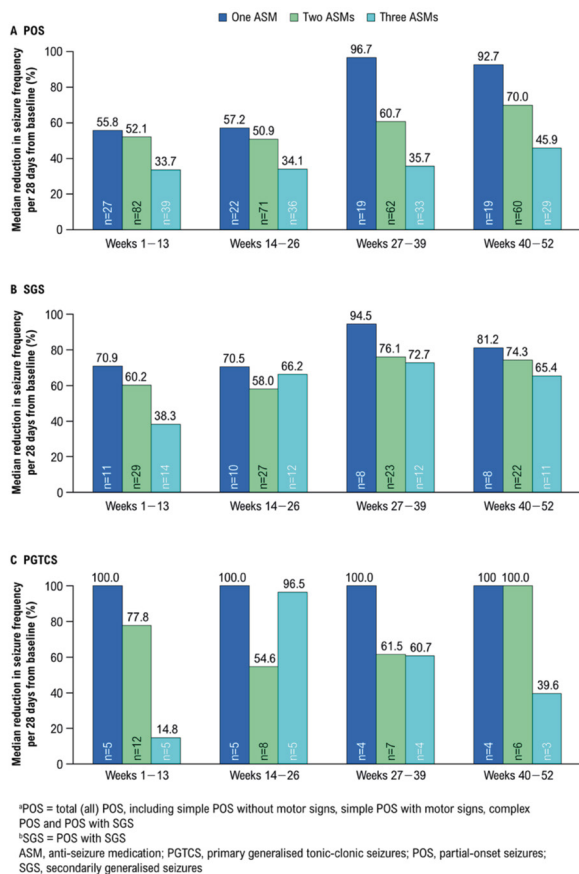

Figure 1. Median percent reduction in seizure frequency per 28 days from baseline by number of baseline ASMs for (A) POS, (B) SGS and (C) PGTCs (Full Analysis Set)

Figure 2. Median percent reduction in seizure frequency per 28 days from baseline by most common concomitant ASMs for (A) POS*, (B) SGS* and (C) PGTCs (Full Analysis Set)

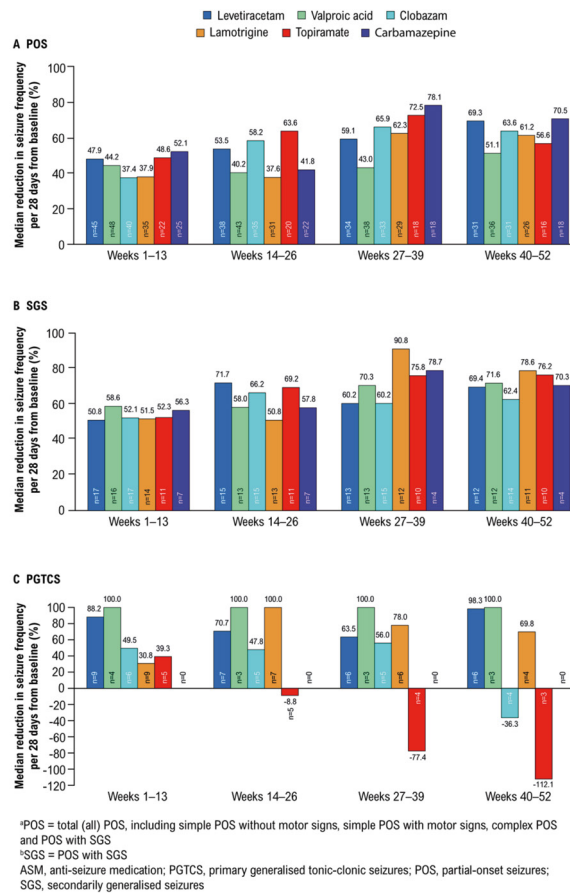

Figure 2. Median percent reduction in seizure frequency per 28 days from baseline by most common concomitant ASMs for (A) POS, (B) SGS and (C) PGTCs (Full Analysis Set)

Conclusion: Long-term (1-year) adjunctive perampanel was generally well tolerated and efficacious in paediatric patients with POS (with/without SGS), irrespective of baseline ASMs; sample size was too small for PGTCs to draw conclusions.

Funding: Eisai Inc.

Disclosure: Study 311 was funded by Eisai Inc. Medical writing support, under the direction of the authors, was provided by Rebecca Furnston, PhD, of CMC AFFINITY, a division of McCann Health Medical Communications Ltd., Macclesfield, UK, in accordance with Good Publication Practice (GPP3) guidelines, funded by Eisai Inc.

EPR3035

Withdrawn

EPR3036

Natural history of Lafora disease: systematic review of literature and metanalysis.

F. Pondrelli¹, L. Muccioli¹, L. Licchetta¹, B. Mostacci², C. Zenesini³, L. Vignatelli², F. Bisulli¹, P. Tinuper¹

¹Department of Biomedical and Neuromotor Sciences, University of Bologna, Bologna, Italy, ²IRCCS Istituto delle Scienze Neurologiche di Bologna, Ospedale Bellaria, Bologna, Italy, ³Epidemiology and Biostatistics, IRCCS Institute of Neurological Sciences of Bologna, Bologna, Italy

Background and aims: Lafora Disease (LD) natural history has been described only in case reports and small series of patients to date. Here we present a systematic review of all the available cases reported in literature, aiming to better define LD course and possibly enucleate prognostic factors, in view of the release of specific therapies in the next future.

Methods: 2 independent reviewers extracted the relevant data from articles selected by using PubMed/MEDLINE database. We included in statistical analysis only genetically confirmed LD cases.

Results: Of 699 citations, 62 studies with a total of 252 cases (214 families) were identified. Mean age at disease onset was 13.8±3.5 years. EPM2A was mutated in 83 families (38.8%), while EPM2B in 131 (61.2%). Mean duration of the disease in 62 deceased cases was 8.2±5.7 years (9.9±9 years in 19 EPM2A cases and 7.5±3.2 years in 43 EPM2B cases). Loss of autonomy (grade 3 of disability scale) occurred after a mean of 6.4±5.6 years from onset (4.8±4.9 years for 20 EPM2A cases and 7.1±5.7 years for 45 EPM2B cases).

Conclusion: Our preliminary analysis suggests that despite mean disease duration appears globally shorter in EPM2B mutated cases, overall survival in LD could vary widely even between cases with the same altered gene, suggesting that mutation type could play a major role. EPM2A cases seems to spend more time in a severe disability state than EPM2B cases. Even if a prospective study is still needed to further characterize the disease, here we have described for the first time a large LD cohort.

Disclosure: Nothing to disclose

EPR3037

Safety of Cenobamate as Adjunctive Treatment for Uncontrolled Focal Seizures: Results from a Large, International, Safety Open-Label Study

J. Sanchez-Alvarez¹, E. Santamarina², I. Milanov³, Y. Winter⁴, C. Brandt⁵, D. Fabo⁶

¹Neurology Service, Hospital Clinico Universitario San Cecilio, Granada, Spain, ²Department of Neurology, Vall d'Hebron University Hospital, Barcelona, Spain, ³Neurology Clinic, Medical University of Sofia, Sofia, Bulgaria, ⁴Mainz Comprehensive Epilepsy Center, Johannes Gutenberg-University, Mainz, Germany, ⁵General Epileptology, Bethel Epilepsy Centre, Mara Hospital, Bielefeld, Germany, ⁶Budapest, Hungary

Background and aims: Cenobamate is a novel antiepileptic drug (AED) with a unique, complementary, dual mechanism of action which has shown a significant seizure frequency reduction, including seizure freedom, in 2 well-controlled studies. Among the first 953 adults exposed to cenobamate, three confirmed cases of drug reaction with eosinophilia and systemic symptoms (DRESS) occurred. This study was designed to assess whether a slower titration and lower starting dose would reduce the incidence of DRESS.

Methods: This ongoing, open-label study enrolled epilepsy patients 18–70-year-old with uncontrolled focal onset seizures taking stable doses of 1-3 AEDs. Increasing daily doses of cenobamate were administered (12.5, 25, 50, 100, 150, and 200mg) at 2-week intervals. Further increases to a maximum dose of 400mg/day by 50mg/day increments every other week were allowed. A key objective was to assess the rate of DRESS after 6 months. Hypersensitivity reactions were reviewed monthly.

Results: 1,340 patients were dosed (2,192 patients/year; July 2019 data cut-off). No cases of DRESS occurred. The most frequent AEs (incidence ≥10%) were somnolence (30.8%), dizziness (26.8%), fatigue (18.8%) and headache (15.5%). Serious AEs occurred in 14.2% of patients, severe AEs in 10.2% and TEAEs leading to discontinuation in 13.1%.

Conclusion: Long-term treatment with adjunctive cenobamate was generally safe and well tolerated, with the most common TEAEs being CNS-related. This study shows preliminary evidence that reducing the starting dose and slowing the titration rate of cenobamate to 2w intervals might mitigate the risk of DRESS.

Disclosure: Study 021 (NCT02535091) was sponsored by SK Life Science, Inc. and the analyses supported by Arvelle Therapeutics International GmbH

EPR3038

Transient and terminal asystoles in focal epileptic seizures: results of continuous ECG monitoring

S. Serdyuk¹, K. Davtyan¹, S. Burd², O. Drapkina³

¹Cardiac Arrhythmia Department, National Medical Research Center for Preventive Medicine, Moscow, Russian Federation, ²Moscow, Russian Federation, ³Director of The Center, National Medical Research Center for Preventive Medicine, Moscow, Russian Federation

Background and aims: Cardiac arrhythmias and conduction disorders in patients with epilepsy are presumably one of the main causes of sudden unexpected death in epilepsy (SUDEP), and they can be identified by long-term ECG monitoring. The aim of this study was to determine the nature and frequency of bradycardia and asystole in patients with persistent epileptic seizures, despite the ongoing antiepileptic therapy, over a long period of time using a loop ECG recorder.

Methods: 193 patients with persistent epileptic seizures were implanted with subcutaneous ECG recorders programmed to record bradycardia, cardiac pauses, ventricular/atrial tachyarrhythmias. The recording was also activated by the patient with the onset of epileptic seizures.

Results: About 6000 ECG fragments were recorded during 36 months of monitoring. More than half of the patients showed changes in heart rhythm in the ictal period, but only 13 (6.7%) of patients in the form of bradycardia and asystole. During the entire follow-up period, 5 (2.6%) patients died due to SUDEP. Analysis of postmortem records showed that at the time of death, bradycardia with subsequent cardiac arrest was recorded on the ECG, however, during the entire previous follow-up period, no rhythm and conduction disturbances were observed. On the other hand, the asystoles recorded in a number of patients in the ictal period were reproducible from seizures to seizures and had a transient nature.

Conclusion: Transient asystoles during seizures and terminal asystole at the time of death indicate not only different pathophysiological mechanisms underlying these types of bradiarrhythmias, but also different prognostic value.

Disclosure: Nothing to disclose

EPR3039

Myocardial ischemia in patients with epilepsy

C. Sioka, A. Tsoumani, C.A. Votti, M. Beltsiou, L. Lakkas, K. Pappas, A. Fotopoulos, A. Kyritsis, S. Markoula

University Hospital of Ioannina, Ioannina, Greece

Background and aims: Patients with epilepsy (PWE) are at increased risk for unexpected death. The determination of causes of death in seizure- and epilepsy-related death is challenging.

The aim of the study was to employ myocardial perfusion imaging (MPI) to evaluate the risk of cardiovascular events in epileptic patients.

Methods: MPIs with ^{99m}Tc tetrofosmin stress – rest single photon emission computer tomography (^{99m}Tc - SPECT) was performed in 28 patients with epilepsy and 32 age-matched individuals. MPI was assessed using 17 segment polar map and with a scale of 0 to 4 scoring. Abnormal MPI was considered when summed stress score was ≥ 4 .

Smoking, hypertension, diabetes mellitus, dyslipidemia, obesity and family history of coronary artery disease were recorded as risk factors for myocardial infarction in both groups. Clinical data of PWE were also recorded.

Results: 28 PWE (F/M: 6/22) with a mean age of 56.86 ± 10.54 and 32 controls (F/M: 7/25) with a mean age of 55.06 ± 9.34 (p: NS) were recruited. PWE had 2.36 ± 1.12 of the aforementioned risk factors vs 2.62 ± 1.04 for the controls (p: NS). They were suffering from pharmacoresistant epilepsy for 26.48 ± 18.50 years and were under a median number of 2 antiepileptic drugs. 18 PWE had abnormal MPI (64.28%) vs 14 controls (43.72%), $p=0.028$.

Conclusion: In a PWE the elevated stress and sympathetic response to the seizure may trigger an acute coronary event. As shown by the results of our study, PWE may suffer from concurrent cardiac disease, a potential explanation for sudden death.

Disclosure: Nothing to disclose

EPR3040

Improving access to ‘first suspected seizure’ services: A Quality Improvement Project in an epilepsy clinicP. Smith¹, M. Pierri²¹Cardiff, ²Epilepsy Unit, University Hospital of Wales, Cardiff, United Kingdom

Background and aims: The diagnosis of a 1st suspected seizure is essentially clinical, with emphasis upon the history and eyewitness account. Some causes of blackouts are life threatening, and for many people blackouts threaten work, education, driving and social interaction. The UK target for specialist assessment of 1st suspected seizures is 2 weeks following referral. Many busy epilepsy services have difficulty maintaining such rapid access.

Methods: We reviewed the 12 months baseline data before the intervention. We process-mapped referrals to the epilepsy service and identified ‘quick wins’; we then conducted iterative quality improvement cycles using ‘Plan–Do–Study–Act’ (PDSA) over 6 months, noting changes to the waiting times following each intervention. Noting several quick wins, we established a weekly multidisciplinary team (MDT) meeting to discuss and triage all referrals into the epilepsy service. We increased the proportion of telephone follow-up (improving patient convenience and shortening consultations), increased numbers seen in the nurse led clinics, and increased discharges to ‘open appointments’.

Results: We reviewed the data at 6 months and at 24 months after starting the interventions. The waiting time for 1st seizure referrals fell from 7–10 weeks (baseline) to consistently below 2 weeks at 6 months and 24 months. The MDT discussed a mean of 28.5 patients weekly. We increased the proportion of telephone review appointment from 8% (baseline) to 29% at 24 months.

Conclusion: Through MDT triage of all referrals to the service, and by freeing space in the routine review epilepsy clinic, we sustainably reduced specialist assessment waiting times following a first suspected seizure.

Disclosure: Nothing to disclose

EPR3041

Long-term epilepsy outcome of post-anoxic refractory status epilepticus after aggressive treatmentL. Tinti¹, S. Beretta¹, A. Coppo², E. Bianchi³, C. Zanchi¹, D. Carone¹, A. Stabile¹, G. Padovano¹, E. Sulmina², A. Grassi², G. Bogliun¹, G. Foti², C. Ferrarese¹, A. Pesenti⁴, E. Beghi⁵, L. Avalli²

¹Epilepsy Center, Department of Neurology, San Gerardo Hospital ASST Monza, University of Milano Bicocca, Monza, Italy, ²Department of Intensive Care, University of Milano Bicocca, Monza, Italy, ³Neuroscience, IRCCS Mario Negri Institute for Pharmacological Research, Milan, Italy, ⁴Department of Anesthesia, Critical Care and Emergency, IRCCS Ospedale Maggiore Policlinico, Milan, Italy, ⁵Neuroscience, IRCCS-Istituto di Ricerche Farmacologiche “Mario Negri”, Milan, Italy

Background and aims: Studies on neurological prognosis after cardiac arrest usually assess functional status, while data about long-term sequelae such as epilepsy are limited.

Methods: 166 consecutive patients with cardiac arrest, in a coma for more than 24 hours, were electroencephalogram (EEG) monitored and enrolled in a previously published study on aggressive treatment of post-anoxic status epilepticus (Beretta et al, Neurology 2018). Patients were classified in the acute phase using four mutually exclusive patterns: continuous and/or reactive EEG (pattern A, 76 patients), status epilepticus by Salzburg criteria (pattern B, 36 patients), generalized periodic discharges (pattern C, 13 patients), discontinuous and unreactive EEG (pattern D, 41 patients). 77 survived at 6 months and were retrospectively contacted by phone calls. A standardized questionnaire assessed the following outcomes: new seizures, new diagnosis of epilepsy after cardiac arrest, seizures before cardiac arrest, usage of antiepileptic drugs (AEDs), Cerebral Performance Category (CPC) score.

Results: 63 patients were contacted, while 14 patients were lost at follow-up (median follow-up: 70 months, range 43–100). Only 2 patients (3.2%) were on long-term AED, both presented pattern B during the acute phase. 1 patient was seizure-free, the other developed chronic focal epilepsy and Lance-Adams syndrome. No pattern A patient developed epilepsy. As regards prognostic indicators, pattern B survivors and non-survivors differed especially by rates of basal EEG reactivity in the acute phase ($p=0.006$).

Conclusion: Although both anoxic insults and status epilepticus are considered risk factors for further seizures, epilepsy was a rare outcome in our population of aggressively treated post-anoxic patients.

Disclosure: Nothing to disclose

EPR3042

Epidemiology, clinical presentation, aetiology, neurophysiological findings, treatment and outcome of nonconvulsive status epilepticus in adults: a 7-year retrospective, hospital-based study

J. Vitor¹, V. Silva¹, A.R. Pinto², N.M.M. Canas²
¹Neurology, HBA, Loures, Portugal, ²Neurophysiology, Hospital Beatriz Ângelo, Loures, Portugal

Background and aims: Nonconvulsive Status Epilepticus (NCSE) comprises a group of heterogenous disorders with different presentations, prognosis and treatment. Clinical diagnosis remains challenging. The aim of this study was to characterise the epidemiology, presentation, aetiology, neurophysiological findings, treatment and outcome of NCSE.

Methods: A retrospective descriptive study was performed on patients diagnosed with NCSE between 2012 and 2019 in Hospital Beatriz Ângelo (Portugal). Patients diagnosed in intensive care were excluded. We applied the 2015 International League Against Epilepsy Definition and Classification of Status Epilepticus and 2015 modified Salzburg Consensus Criteria.

Results: Total number of patients was 67 (24-93 years; 39 female), 23 had previous history of epilepsy and 19 had dementia. 11 patients presented as NCSE with coma and 56 without coma (51 focal with impaired consciousness, 4 aphasic status and 1 aura continua). In 55 (82%) patients NCSE had an acute precipitating cause or was remotely provoked. EEG fulfilled direct diagnostic criteria (>2,5Hz epileptiform discharges) in 34% of patients and 66% required an additional minor criterion (51% with <2,5Hz epileptiform discharges and 15% with rhythmic delta/theta activity). In 46% of patients only one antiepileptic drug was necessary; coma was induced in 5 patients; 12 patients had sequelae and 14 patients died.

Conclusion: In our population, NCSE was frequently the first epileptic manifestation. Clinical features were diverse and often subtle and EEG was frequently essential to the diagnosis. In the majority of patients a cause was identified. Although its treatment was relatively easy, NCSE had a high morbidity-mortality rate.

Disclosure: Nothing to disclose

EPR3043

Seizure onset zone and seizure networks: Multiple SISCOm hyperperfusion areas and surgical outcome

T.J. Von Oertzen¹, M. Weiss¹, S. Katletz¹, G. Puttinger¹, G. Schwarz¹, A.M. Hengsberger¹, A. Gruber², J. Trenkler³, R. Pichler⁴

¹Department of Neurology ¹, Kepler Universitätsklinikum, Linz, Austria, ²Department of Neurosurgery, Kepler Universitätsklinikum, Linz, Austria, ³Neuroradiology, Neuromed Campus, Kepleruniversitätsklinikum Linz, Linz, Austria, ⁴Nuclear Medicine, Kepler Universitätsklinikum, Linz, Austria

Background and aims: In presurgical evaluation of drug refractory epilepsy subtraction ictal SPECT co-registered with MRI (SISCOm) is a diagnostic tool applied in case of discordant results, non-lesional MRI or for planning of intracranial electrodes. We recently described high reliability with a high rate of overlapping results in multiple SISCOms. Here, we correlate surgical site and postsurgical outcome to multiple SISCOms hyperperfusion areas.

Methods: All patients undergoing resective epilepsy surgery were screened for the study. Those with additional results of multiple SISCOms were included. Results of multiple SISCOms including overlap and correlation maps as well as single SISCOm results were compared to surgical site, histology and postsurgical outcome according to Wieser classification.

Results: So far, 9 patients with multiple SISCOms underwent resective surgery. Site of surgery was concordant to overlapping SISCOm activation in 4 patients. In 2 patients only 1 of the SISCOms showed hyperperfusion areas concordant with site of surgery and in 3 patients hyperperfusion areas in SISCOm were discordant. Median postsurgical follow up at time of abstract submission was less than 1 year. Outcome data will be provided on the poster therefore.

Conclusion: In this preliminary analysis of multiple SISCOms hyperperfusion areas, less than 50% of cases showed correlation to site of surgery. Together with single SISCOm results, 66% were localizing. Seizure control over one year will be reported for the presentation. Multiple SISCOms analysis compared to surgical outcomes will contribute to the understanding of network effects responsible for good surgical outcomes.

Disclosure: Nothing to disclose

EPR3044

Treatment Guidelines for Five Rare Neurodevelopmental Disorders: A Targeted Literature Review

R. Chin¹, A. Mingorance², I. Newell³, B. Ruban-Fell³, J. Evans⁴, K. Vyas⁵, C. Nortvedt⁵, S. Amin⁶

¹Royal Hospital for Sick Children, Edinburgh, United Kingdom, ²Dracaena Consulting, Madrid, Spain, ³Costello Medical, London, United Kingdom, ⁴Costello Medical, Cambridge, United Kingdom, ⁵GW Pharmaceuticals, London, United Kingdom, ⁶Bristol Royal Hospital for Children, Bristol, United Kingdom

Background and aims: Lennox-Gastaut syndrome, Dravet syndrome and CDKL5 deficiency disorder (CDD) are rare epileptic disorders characterised by severe seizures in early childhood. Severe seizures are also common in the rare genetic conditions tuberous sclerosis complex and Rett syndrome. Due to seizure severity and unique treatment needs, high-quality treatment guidelines are required to optimise care. This review aimed to characterise methods of development, availability and content of treatment guidelines for these disorders.

Methods: A targeted literature review of treatment guidelines was conducted in February/March 2019 by manually searching online rare disease and guideline databases, and health technology assessment body/regulatory agency websites from target countries, defined using pre-specified eligibility criteria (Table 1; no date limit applied). Search terms, developed for each condition, were translated into appropriate languages to identify guidelines specifically for use in countries of interest. Guideline development methodology, geographical focus and treatment recommendations were extracted from guidelines using a pre-determined extraction grid.

	Inclusion criteria	Exclusion criteria
Population	Patients with the following epileptic conditions: <ul style="list-style-type: none"> • Dravet syndrome • Lennox-Gastaut syndrome • Tuberous sclerosis complex • Rett syndrome • CDKL5 deficiency disorder 	Conditions other than those listed
Intervention	Any	None
Outcomes	The document must have discussed the management of the conditions of interest in terms of pharmacological treatment pathways for routine seizure control	<ul style="list-style-type: none"> • Documents that did not discuss the management in terms of pharmacological treatment pathways • Emergency medication and surgical guidelines
Publication type	Guidelines or guidance documents	Publications other than guidelines
Other considerations	Specifically produced for use in: <ul style="list-style-type: none"> • EU5 countries (UK, Germany, Spain, Italy, France) • Japan • Australia • Switzerland • Israel • Canada International guidelines (i.e. guidelines produced for multiple countries that included or potentially included the countries of interest, or guidelines that did not specify which countries they pertained to)	Produced specifically for use in countries that were not of interest

Sources searched included: Guideline Central, National Organization for Rare Disorders, International League Against Epilepsy, Orphanet. Websites of National Health Technology Assessment (HTA) bodies for countries of interest were also searched.

Table 1. Eligibility criteria

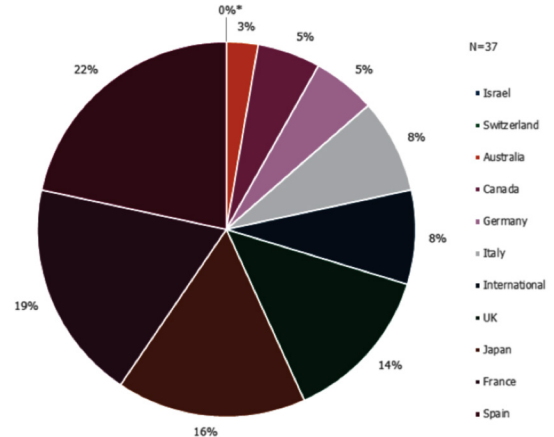

*No treatment guidelines were identified for Israel and Switzerland. Two guidelines identified for Canada were developed specifically for the provinces of Ontario and British Columbia. Two Spanish guidelines were developed specifically for Andalusia. One Italian guideline was developed specifically for Tuscany.

Figure 1. Geographical focus of treatment guidelines

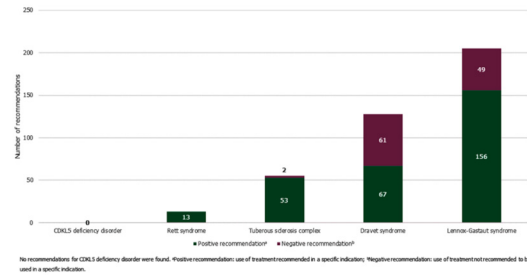

Figure 2. Positive and negative treatment recommendations by indication

Conclusion: There is a need for international collaboration to develop further high-quality and comprehensive consensus-based treatment guidance for these five neurodevelopmental disorders.

Disclosure: This study was funded by GW Pharmaceuticals; editorial services were provided by Costello Medical; R. Chin, has provided consultancy and speaker services, and has participated in events and studies, for GW Pharmaceuticals, Eisai, Zogenix and Neopharm Group; A. Mingorance, has provided consultancy to Encoded Therapeutics, F. Hoffmann-La Roche, GW Pharmaceuticals, Neurelis, Ovid Therapeutics, and Praxis Precision Medicines; I. Newell, employee of Costello Medical; B. Ruban-Fell, employee of Costello Medical; J. Evans, employee of Costello Medical; K. Vyas, employee of GW Pharmaceuticals; C. Nortvedt, employee of GW Pharmaceuticals; S. Amin, has no potential conflict of interest.

Headache and pain 5

EPR3045

Real-world evidence data characterizing the use of the monoclonal antibody Erenumab in daily clinical routine in Germany from the treating physician's perspective

M. Koch¹, A. Straube², P. Stude³, C. Gaul⁴, K. Schuh¹
¹TA Neuroscience, Novartis Pharma GmbH, Nuremberg, Germany, ²Department of Neurology, Klinikum Grosshadern, Munich, Germany, ³Neurologische Praxis Bochum, Bochum, Germany, ⁴Königstein, Germany

Background and aims: Erenumab, the first-in-class fully human monoclonal antibody against the CGRP receptor, has demonstrated efficacy and safety in clinical studies. This data collection now aims to collect first real-world data by characterizing the use of erenumab in clinical practice from the point of view of treating physicians in Germany.

Methods: Data from 70 headache centers across Germany has been collected by an online survey from July-December 2019. First, the use of erenumab is characterized from the treating physician's perspective with regards to therapy decision, patient profiles and quality of life of the patients. Second, each center documented 10-20 individual episodic and chronic migraine patients who had already completed 3 months of treatment with erenumab for their treatment effects and satisfaction with outcome.

Results: An interim analysis of 109 patients showed that on average there was a reduction of 8 migraine days under erenumab therapy. Physicians reported that 75% of their patients already had a response after the 1st injection. Based on observations during patient visits, physicians noted that 80% of the patients felt a reduction of intensity of migraine attacks and in general, they rated 80% of the patients as 'much improved' and 'very much improved' on the global impression score. The full data set including >700 erenumab patients will be available for EAN congress.

Conclusion: The TELESCOPE study provides real world data for erenumab in Germany regarding treatment routines, typical patient profiles and the effect on daily functioning and quality of life, both outcomes with great impact on migraine patients.

Disclosure: This study has been funded by Novartis Pharma GmbH.

EPR3046

Microstructural abnormalities precede cutaneous allodynia in patients with migraine.

F. Scotto Di Clemente¹, A. Russo¹, M. Silvestro¹, A. Bisecco¹, F. Di Nardo², F. Esposito³, A. Tessitore¹, M.P.G. Tedeschi¹

¹Department of Medical, Surgical, Neurological, Metabolic and Aging Sciences, University of Campania "Luigi Vanvitelli", Naples, Italy, ²MRI Research Centre, University of Campania "Luigi Vanvitelli", Naples, Italy, ³Department of Medicine, Surgery and Dentistry, Scuola Medica Salernitana, University of Salerno, Salerno, Italy

Background and aims: Cutaneous allodynia (CA) is complained by 2/3 of patients with migraine without aura (MwoA). CA is a clinical symptom of central nociceptive pathway sensitization and an independent predictor for migraine chronification.

We aim to investigate structural brain abnormalities could precede the development of CA in patients with MwoA.

Methods: 37 patients with MwoA were recruited and underwent MRI scan. All patients have been followed over a 3-years period and divided into 2 sub-groups based on CA development. In this way, 20 patients with MwoA who have developed CA (MwoA dCA) and 17 patients with MwoA who have not developed CA (MwoA ndCA) has been identified and compared with 19 sex- and age-matched healthy controls (HC).

Tract-based spatial statistics (TBSS) method was applied to investigate white matter alterations.

Results: TBSS analysis revealed a reduced fractional anisotropy (FA) of the corpus callosum (CC) in patients with MwoA dCA when compared with MwoA ndCA and HC. No significant correlations have been found between the TBSS changes observed in the CC and any clinical parameters of disease severity.

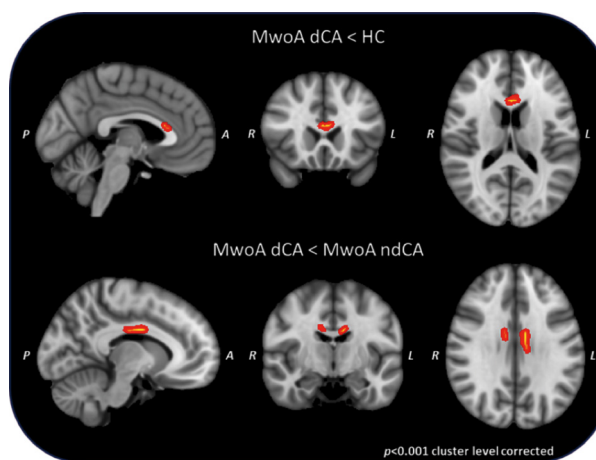

Reduced fractional anisotropy (FA) of the corpus callosum (CC) in patients with MwoA dCA when compared with both MwoA ndCA and HC

Conclusion: Our data showed microstructural changes in patients with MwoA. FA abnormalities are more evident in patients with MwoA dCA when compared with patients with MwoA ndCA. Reduced FA of CC has been previously reported in patients with MwoA with comorbidities known to be related to migraine chronification (depression and medication overuse headache). Based on this observations we speculate that our findings might represent a negative prognostic biomarker able to identify phenotype of patients more prone to migraine chronification.

Disclosure: Nothing to disclose

EPR3047

Changes in Acute Migraine-Specific Medications after Initiating Erenumab: Results from a Real-World Retrospective Cohort Study in the United States

D. Hines¹, S. Shah², J. Multani¹, R. Wade¹, D. Buse³, M. Bensink²

¹*IQVIA Inc, Durham, USA*, ²*Amgen Inc, Thousand Oaks, USA*, ³*Albert Einstein College of Medicine, Bronx, USA*

Background and aims: Overuse of acute migraine-specific medications (AMSMs) can potentially complicate migraine management. Erenumab, a calcitonin gene-related peptide antagonist, significantly reduces the use of AMSMs in migraine patients. We aimed to examine the real-world changes in AMSMs use among patients prescribed erenumab in the United States.

Methods: We conducted a retrospective cohort study using data from IQVIA's open source pharmacy and medical claims databases. Patients aged 18 years or older were included if they had completed an adequate trial of erenumab (≥ 3 claims) from 1 May 2018 to 30 April 2019 (1st claim was the index date) with data continuity in the 12 months prior to and ≥ 6 months following the index date. Post-index change in AMSMs use (triptans and ergotamine derivatives used both pre-and-post-index) included discontinuation (no refills for ≥ 60 days after the last post-index fill) and change (post-pre index) in units (tablets/pills) filled.

Results: We identified 43,185 patients who received ≥ 3 doses of erenumab (female, 85.8%; average [standard deviation (SD)] age, 47 [12.9] years). After initiation of erenumab, AMSMs were discontinued in 36.8% (8556/23,222) patients with both pre- and post-index use (triptans, 35.9% [8021/22,338]; ergotamines, 60.5% [535/884]). AMSMs units changed in 80.0% (18,571/23,222) patients; for triptans, in 80.7% (18,034/22,338), and in 60.7% (537/884) for ergotamines, with an overall mean [SD] change of -1.2 [6.6] units for triptans and -0.4 [6.9] units for ergotamines

Conclusion: In this US-focused real-world study, a proportion of patients completing an adequate trial of erenumab discontinued and/or reduced consumption of their AMSMs.

Disclosure: This study was funded by Amgen Inc., Thousand Oaks, CA, USA. Erenumab is co-developed by Amgen and Novartis. A detailed disclosure from each author will be included in the oral/poster presentation. Abstract also submitted to AAN 2020; acceptance outstanding.

EPR3048

Sustained Benefits of OnabotulinumtoxinA Treatment in Chronic Migraine: Results from a PREEMPT Pooled Analysis

S. Silberstein¹, H.-C. Diener², D. Dodick³, L. Luo⁴, L. Yedigarova⁵, R. Lipton⁶

¹Thomas Jefferson University, Philadelphia, USA,

²University of Duisburg-Essen, Essen, Germany, ³Mayo Clinic, Phoenix, USA, ⁴Allergan plc, Madison, USA,

⁵Allergan plc, Irvine, USA, ⁶Albert Einstein School of Medicine, Bronx, USA

Background and aims: Determine proportion of individuals with chronic migraine (CM) that achieved <15 monthly headache days (MHDs) following continuous onabotulinumtoxinA treatment.

Methods: Observed data from PREEMPT (24-week, 2 onabotulinumtoxinA cycle, randomized, double-blind placebo-controlled phase, followed by 32-week, 3 onabotulinumtoxinA cycle, open-label phase) were pooled for analysis. To assess MHD reductions (<15), several time periods were analyzed: 1) end of double-blind (21-24 weeks) or open-label (53-56 weeks); 2) any 3 consecutive months of double-blind (1-24 weeks) or entire study (1-56 weeks); and 3) all months end of double-blind (13-24 weeks; termed 'treatment-controlled CM') or entire open-label (25-56 weeks; termed 'sustained treatment-controlled CM'). Proportion of participants (double-blind: onabotulinumtoxinA vs. placebo; open-label: onabotulinumtoxinA only) achieving each classification, with mean MHDs, presented as exploratory post-hoc analyses with Bonferroni correction (significance $p \leq 0.008$).

Results: 1384 participants randomized to onabotulinumtoxinA (n=688) or placebo (n=696) in double-blind; most continued to open-label (n=607 onabotulinumtoxinA/onabotulinumtoxinA, n=629 placebo/onabotulinumtoxinA). A higher proportion of onabotulinumtoxinA-treated individuals compared to placebo achieved <15 MHD and had lower mean MHDs[SD] last month of double-blind (67.4% [n=363/539] vs. 58.0% [n=322/555], $p=0.001$; 6.9 [4.0] vs. 7.7[4.1], $p=0.021$, respectively), any 3 consecutive months of double-blind (61.2% [n=359/587] vs. 52.3% [n=315/602], $p=0.002$; 8.3 [3.5] vs. 8.9 [3.5], $p=0.022$), and/or treatment-controlled CM end of double-blind (56.3% [n=334/593] vs. 48.3% [n=290/600], $p=0.006$; 6.5 [3.6] vs. 7.2 [3.4], $p=0.007$). In onabotulinumtoxinA-treated, 79.8% (n=319/400) achieved <15 MHD last month of open-label (mean MHDs[SD]: 4.9 [4.1]), 73.3% (n=440/600) any 3 consecutive months of entire study (7.7 [3.9]), and/or 59.9% (n=333/556) sustained treatment-controlled CM for entire open-label (4.5[3.2]).

Conclusion: In PREEMPT, a high proportion of onabotulinumtoxinA-treated individuals achieved sustained treatment-controlled CM for the entire observed open-label phase.

Disclosure: This study was sponsored by Allergan plc.

EPR3049

Cognitive networks disarrangement in patients with migraine predicts cutaneous allodynia.

M. Silvestro¹, A. Russo¹, A. Bisecco¹, R. De Micco¹, F. Di Nardo², F. Esposito³, A. Tessitore¹, G. Tedeschi¹

¹Department of Medical, Surgical, Neurological, Metabolic

and Aging Sciences, University of Campania "Luigi Vanvitelli", Naples, Italy, ²MRI Research Centre SUN-FISM, University of Campania "Luigi Vanvitelli", Naples, Italy,

³Department of Medicine, Surgery and Dentistry, Scuola Medica Salernitana, University of Salerno, Salerno, Italy

Background and aims: 2/3 of patients with migraine without aura (MwoA) complain cutaneous allodynia (CA) during the attacks. CA is a clinical sign of central nociceptive pathway sensitization and independent predictor for migraine chronification. We aim to investigate whether abnormalities of the functional connectivity (FC) of the brain cognitive networks (default mode network (DMN) and the central executive network (CEN)) could predict the development of CA in patients with MwoA.

Methods: 37 patients with MwoA were recruited and underwent fMRI. All these patients have been followed over a 3 years' period and then divided into 2 groups based on whether or not CA was developed. Then, we compared FC within the cognitive network in 20 patients with MwoA who have developed CA (MwoA dCA) versus 17 patients with MwoA who have not developed CA (MwoA ndCA) and 19 sex- and healthy controls (HC).

Results: We observed a significantly reduced FC of both DMN (within anterior cingulate cortex (ACC), medial frontal gyrus (MFG) and insula) and CEN (posterior cingulate cortex (PCC)/precuneus) and in patients with MwoA dCA when compared with both patients with MwoA ndCA and HC.

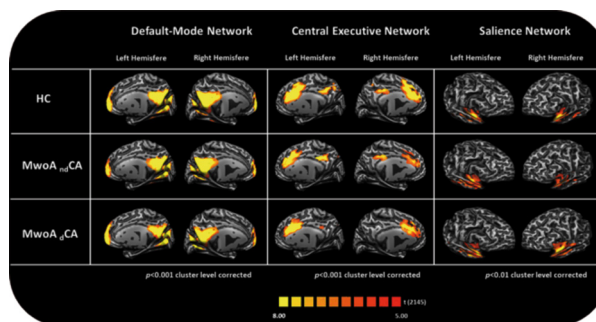

Conclusion: The reduced FC of PCC/precuneus (key hub of DMN involved in multisensory integration) could subtend an abnormal integration of inputs from different sensory modalities and, subsequently, the development of CA. The reduced FC of ACC and MFG (central hubs of CEN involved in pain perception and in executive functions) could reflect a subclinical impairment of complex executive functions making these patients more prone to the development of migraine attacks.

Disclosure: Nothing to disclose

EPR3051

Effects of galcanezumab on health-related quality of life in patients with treatment-resistant migraine: Results from CONQUER study

S.J. Tepper¹, J. Ailani², J.H. Ford³, R.M. Nichols³, L.Q. Li³, S. Wang³

¹Geisel School of Medicine at Dartmouth, Hanover, USA, ²Medstar Georgetown University, Washington DC, USA, ³Eli Lilly and Company, Indianapolis, USA

Background and aims: The CONQUER study assessed health outcome measures with galcanezumab in patients with treatment-resistant episodic (EM) or chronic migraine (CM). Treatment resistance was defined as previous failure with 2 to 4 standard-of-care migraine preventive medication categories in the past 10 years due to inadequate efficacy and/or safety/tolerability reasons.

Methods: In the study, patients with treatment-resistant migraine (EM or CM) were randomized 1:1 to receive galcanezumab (GMB) 120mg/month (with 240mg loading dose) or placebo (PBO) during a 3-month double-blind period. Migraine Disability Assessment (MIDAS) and European Quality of Life 5-Dimensions 5-Levels (EQ-5D-5L) scores were collected at baseline and Month 3. Migraine-Specific Quality of Life Questionnaire v2.1 (MSQ) was collected at baseline and monthly. Treatment comparisons were done at Month 3 using mixed model repeated measures (in case of repeated measures) and analysis of covariance models (single post-baseline measure).

Results: Baseline values for all scores were balanced between PBO and GMB groups (Table 1). In the intent-to-treat population (N=462) and in subpopulations with EM (N=269) and CM (N=193), there were significantly greater mean improvements from baseline with GMB versus PBO for MSQ total and all domain scores (all p<0.0001), and MIDAS total scores (intent-to-treat [p<0.0001], EM [p=0.0002], CM [p=0.0142]) (Table 2). Mean improvement with GMB versus PBO on EQ-5D-5L visual analog scale was significant (p=0.03) in the intent-to-treat population (Table 2).

Table 1: Baseline scores in different patient populations

	Intent-to-treat population ^a		EM subpopulation ^b		CM subpopulation ^c	
	PBO	GMB	PBO	GMB	PBO	GMB
Age, mean (SD)	45.67 (12.33)	45.87 (11.34)	46.28 (11.75)	45.91 (11.21)	44.84 (13.09)	45.81 (11.60)
Female, n (%)	202 (87.83)	195 (84.05)	117 (88.64)	112 (81.75)	85 (86.73)	83 (87.37)
Race – White, n (%)	182 (81.61)	183 (81.70)	115 (88.46)	118 (88.72)	67 (72.04)	65 (71.43)
Migraine headache days/month, mean (SD)	13.01 (5.73)	13.44 (6.08)	9.20 (2.65)	9.47 (2.98)	18.14 (4.67)	19.17 (4.68)
Duration of migraine illness, years, mean (SD)	23.76 (13.86)	22.73 (13.24)	22.90 (13.05)	21.72 (12.72)	24.92 (14.86)	24.18 (13.88)
Scores, Mean (SD)						
MSQ role function-restrictive	43.95 (18.49)	45.81 (16.00)	46.54 (17.14)	48.55 (14.72)	40.47 (19.73)	41.86 (17.01)
MSQ role function-preventive	63.04 (19.64)	63.84 (19.12)	64.66 (18.74)	64.74 (19.63)	60.87 (20.68)	62.53 (18.38)
MSQ emotional function	51.91 (26.73)	54.80 (24.59)	57.42 (25.10)	59.51 (22.86)	44.49 (27.17)	48.00 (25.52)
MSQ total score	51.11 (18.44)	52.89 (16.27)	54.05 (17.12)	55.53 (15.61)	47.16 (19.48)	49.08 (16.51)
MIDAS total score	50.96 (45.50)	50.90 (45.96)	37.14 (26.17)	41.31 (34.31)	69.56 (57.90)	64.73 (56.20)
EQ-5D-5L VAS score	73.15 (18.23)	72.65 (18.70)	76.92 (16.91)	75.34 (17.55)	68.07 (18.78)	68.77 (19.70)

^aAll patients who were randomized and received at least 1 dose of investigational product; ^bAll patients with EM who were randomized and received at least 1 dose of investigational product; ^cAll patients with CM who were randomized and received at least 1 dose of investigational product

CM=chronic migraine; EM=episodic migraine; EQ-5D-5L=European Quality of Life 5-Dimensions 5-Levels; GMB=galcanezumab; MIDAS=Migraine Disability Assessment; MSQ=Migraine-Specific Quality of Life Questionnaire v2.1; PBO=placebo; SD=standard deviation; VAS=Visual Analog Scale

Baseline scores in different patient populations

Table 2: Mean change from baseline at Month 3 in health-related quality of life measures in different patient populations

Scores, LS mean change (SE)	Intent-to-treat population ^a		EM subpopulation ^b		CM subpopulation ^c		
	PBO	GMB	PBO	GMB	PBO	GMB	
MSQ	Role function-restrictive	10.68 (1.34)	23.21 [†] (1.35)	11.88 (1.80)	23.39 [†] (1.79)	6.71 (1.99)	20.61 [†] (2.05)
	Role function-preventive	7.68 (1.19)	17.53 [†] (1.20)	8.94 (1.56)	18.44 [†] (1.55)	5.37 (1.83)	15.27 [†] (1.88)
	Emotional function	12.02 (1.60)	24.02 [†] (1.61)	11.58 (2.08)	22.52 [†] (2.06)	11.09 (2.57)	24.38 [†] (2.63)
	Total score	10.08 (1.25)	21.67 [†] (1.26)	10.91 (1.67)	21.70 [†] (1.66)	7.67 (1.86)	20.17 [†] (1.91)
MIDAS	Total	-3.30 (3.28)	-21.10 [†] (3.32)	-2.58 (3.68)	-18.96 ^{**} (3.63)	-1.68 (6.19)	-20.27 [*] (6.40)
EQ-5D-5L	VAS score	-0.09 (1.29)	3.38 [*] (1.31)	-0.83 (1.63)	2.90 (1.63)	NA	NA

[†]p<0.05, ^{**}p<0.01, ^{††}p<0.0001 versus placebo

^aAll patients who were randomized and received at least 1 dose of investigational product; ^bAll patients with episodic migraine who were randomized and received at least 1 dose of investigational product; ^cAll patients with chronic migraine who were randomized and received at least 1 dose of investigational product

CM=chronic migraine; EM=episodic migraine; EQ-5D-5L=European Quality of Life 5-Dimensions 5-Levels; GMB=galcanezumab; LS=least squares; MIDAS=Migraine Disability Assessment; MSQ=Migraine-Specific Quality of Life Questionnaire v2.1; NA=not available; PBO=placebo; SE=standard error; VAS=Visual Analog Scale

Mean change from baseline at Month 3 in health-related quality of life measures in different patient populations

Conclusion: Patients with treatment-resistant migraine treated with GMB reported improvements in daily functioning and patient perception of health state, and decreased disability compared to PBO.

Disclosure: This study was sponsored and funded by Eli Lilly and Company

EPR3052

Benefit of Migraine Prevention with Erenumab in Patients Receiving Background Standard-of-Care Acute Treatment

A.J. Starling¹, S.J. Tepper², C. Bernstein³, J. Ailani⁴, F. Zhang⁵, G. Paiva Da Silva Lima⁵, D.E. Chou⁵
¹Department of Neurology, Mayo Clinic, Scottsdale, AZ, USA, ²Geisel School of Medicine at Dartmouth, Hanover, NH, USA, ³Department of Neurology, Harvard Medical School and Brigham and Women’s Hospital, Boston, MA, USA, ⁴Medstar Georgetown University Hospital, Washington, DC, USA, ⁵Amgen Inc., Thousand Oaks, CA, USA

Background and aims: Erenumab is approved for migraine prevention in adults. Its benefit in patients using acute migraine-specific medications (AMSMs, e.g. triptans) has not been established. Here we assess the effect of erenumab (erenumab-aooe in the US) on AMSM use in patients with episodic (EM) and chronic migraine (CM).

Methods: A post hoc analysis of a subgroup with ≥4 days of AMSM use during the 4-week baseline period of 2 pivotal trials in EM (STRIVE, NCT02456740) and CM (NCT02066415) compared preventive treatment (erenumab 70 and 140mg) plus AMSM use with AMSM use alone (placebo arm); all patients continued AMSMs as needed. Change from baseline in monthly migraine days (MMD), monthly AMSM usage days, Headache Impact Test-6 (HIT-6) and Migraine Disability Assessment (MIDAS) scores (EM, averaged over Months 4–6; CM, Month 3) were assessed.

Results: The analysis included 428 EM (erenumab 70mg, n=136; erenumab 140mg, n=144; AMSM use alone, n=148) and 457 CM (n=122; n=135; n=200, respectively) patients. Erenumab plus AMSMs significantly reduced MMD and monthly AMSM use days compared with AMSM use alone in EM and CM (Table). HIT-6 and MIDAS scores were also significantly reduced.

Outcome measures	Episodic migraine		Chronic migraine	
	Erenumab 70 mg + AMSM n=136	Erenumab 140 mg + AMSM n=144	Erenumab 70 mg + AMSM n=122	Erenumab 140 mg + AMSM n=135
MMD*	-2.1 [-2.8, -1.4]	-2.9 [-3.6, -2.2]	-2.2 [-3.4, -0.9]	-3.3 [-4.5, -2.1]
Monthly AMSM days*	-1.9 [-2.5, -1.3]	-2.6 [-3.2, -2.0]	-2.5 [-3.6, -1.4]	-3.6 [-4.7, -2.5]

Data indicates difference in LSM (95% CI). *p<0.001
MMD, Monthly migraine days; AMSM, Acute migraine-specific medication

Benefit of erenumab in patients using acute migraine-specific medications

Conclusion: This study demonstrated that preventive treatment with erenumab plus AMSMs as needed significantly reduced MMD, AMSM use, and disability compared with AMSMs alone. These findings suggest a clinical benefit of effective prevention with erenumab over acute treatment alone in patients using AMSMs at baseline.

Disclosure: Amgen Inc., Thousand Oaks, CA, USA, funded this study. Erenumab is co-developed by Amgen and Novartis. A detailed disclosure from each author will be included in the oral/poster presentation. Abstract also submitted to AAN 2020; acceptance outstanding.

EPR3053

Biomarker for fibromyalgia – are we (already) there?

D. Evdokimov¹, C. Erbacher¹, G. Moshitzky², D. Greenberg², H. Soreq², C. Sommer³, N. Üceyler⁴
¹Neurology, University of Würzburg, Würzburg, Germany, ²HUJI, Edmond and Lily Safra Center for Brain Sciences, and Department of Biological Chemistry, Jerusalem, Israel, ³Department of Neurology, Universitätsklinikum Würzburg, Würzburg, Germany, ⁴Würzburg, Germany

Background and aims: Evidence is increasing for peripheral mechanisms underlying pain in fibromyalgia syndrome (FMS) including small fiber pathology and systemic immune alterations.

Methods: We investigated 156 patients with FMS and applied 5 clinical small fiber tests including skin biopsy, quantitative sensory testing, corneal confocal microscopy, pain-related evoked potentials, and microneurography. We further withdrew blood and generated keratinocyte cultures from skin punch biopsies to assess potential systemic and local microRNA signatures.

Results: We found small fiber pathology in a subgroup of FMS patients including morphological, functional, and electrophysiological properties. In 63% of patients, skin innervation was abnormal and associated with disease severity. In blood and keratinocyte miRNA analysis we found 69 versus 41 deregulated microRNAs. We identified fatty acid synthesis and factor forkhead box protein O1 (FOXO1) (blood) and extracellular matrix receptor (keratinocytes) signaling as potential key pathways. miR-576-5p was validated as a distinguishing microRNA between FMS and healthy controls (p<0.001) and FMS and patients with depression with pain as disease controls (p<0.01).

Conclusion: Our data further support small nerve fiber impairment in FMS subgroups as potential peripheral contributor to FMS pain, and that the extent of small fiber impairment may reflect FMS severity. We further provide hints for systemic and local miRNA alterations in FMS that may be instrumental as diagnostic signatures and for targeted treatment.

Disclosure: Nothing to disclose

EPR3054

Pharmacokinetics, safety and tolerability of lasmiditan in healthy elderly subjects

D. Wilbraham, E. Doty, H. Hochstetler, Y. Yu
Eli Lilly and Company, Indianapolis, USA

Background and aims: Lasmiditan is a 5-hydroxytryptamine 1F receptor agonist approved for the acute treatment of migraine in adults. Unlike triptans, it lacks coronary vasoconstrictor activity, and can be used in patients with cardiovascular disease. We compared the pharmacokinetics, safety and tolerability of lasmiditan in elderly and young healthy subjects.

Methods: 2 randomized, double-blind, crossover studies were conducted. In the 1st, elderly subjects (≥ 65 years) received lasmiditan 200mg and placebo; young subjects aged 18-45 years received open-label lasmiditan 200mg. Plasma samples were taken for pharmacokinetic analysis. As unexpected BP elevations occurred in elderly subjects, a non-inferiority study was conducted to assess BP using ambulatory monitoring. Elderly subjects received lasmiditan 100 and 200mg, and placebo. Non-inferiority (margin 10mmHg) for baseline subtracted peak hourly mean systolic BP (SBP) for lasmiditan versus placebo was determined.

Results: Study 1: maximum lasmiditan concentrations and time to maximum concentrations were not significantly different between elderly (n=18) and young (n=17) subjects. The geometric least squares mean ratio for lasmiditan area under the concentration versus time curve from zero to infinity (elderly:young) was 1.26 (90% confidence interval, 1.03-1.55). Study 2 (n=36): the difference in peak hourly mean SBP change for both lasmiditan doses versus placebo was <10 mmHg at all time points ($p < 0.0001$ for all comparisons). Lasmiditan was generally well tolerated.

Conclusion: Exposure to lasmiditan 200mg was 26% higher in elderly than young subjects but this was clinically irrelevant. Lasmiditan was non-inferior to placebo regarding elevation of BP in elderly subjects. Therefore, lasmiditan dose adjustment is not necessary in the elderly.

Disclosure: All authors are full-time employees and minor shareholders of Eli Lilly and Company.

Infectious diseases 2

EPR3055

Acute necrotizing encephalopathy in childhood - Case seriesN. Elsaid¹, A. Saied¹, Z. Ahmed², F. Sherif²¹Neurology, Mansoura University, Faculty of Medicine, Mansoura, Egypt, ²Radiology, Mansoura University, Faculty of Medicine, Mansoura, Egypt

Background and aims: Acute necrotizing encephalopathy (ANE) is an under-recognized clinic-radiologic disorder characterized by rapid alteration of consciousness, seizures and nonspecific symptoms following or accompanying respiratory or gastrointestinal infection and high fever with radiological symmetric lesions in the magnetic resonance imaging involving the thalami, brainstem, cerebellum, and white matter. This disease has global distribution but more commonly seen in immune-competent East Asian infants and children. The condition carries a poor prognosis with high morbidity and mortality rates.

Methods: Case presentation of three recently encountered cases of ANE. In an attempt to increase the recognition of ANE, we present the clinical, laboratory and MR imaging findings of these three patients.

Results: Three children recently presented with rapid neurological deterioration and fever after prodromal respiratory symptoms. Magnetic resonance imaging examination performed showed symmetric lesions involving the thalami and brainstem. Based on the temporal evolution of the clinical symptoms and MRI findings, the diagnosis of ANE was considered. Also, they carried a relatively bad prognosis based on the MR prognostic score and the ANE severity scale. Unfortunately, 2 cases died and the third was discharged in a vegetative state.

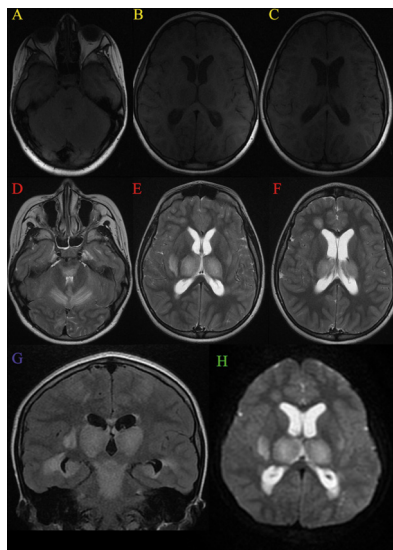

Case 1 MRI showing bilateral lesions involving the thalami, dorsal pons, midbrain, right basal ganglia and right frontal lobe; hypo-intense on T1(A-C), hyper-intense in T2 (D-F) and FLAIR coronal view (G), with evidence of restricted diffusion in DWI (H)

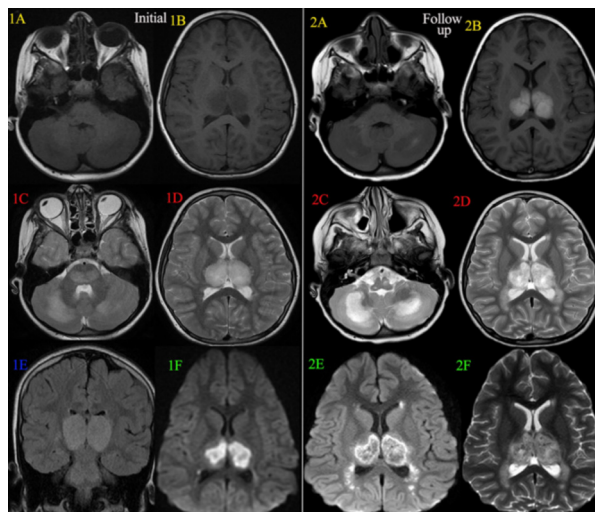

Case 2 initial(1) & 10 d follow up(2) MRI show low SI in both thalami in T1(1a,1b) with follow up evidence of hemorrhage(2a,2b). Initial(1c,1d) & follow up(2c,2d) T2 show high SI in the thalami, cerebelli & brain stem, same as in FLAIR(1e). Initial (1f) & follow up (2e) DWI show trilaminar appearance, apparent also in ADC(2f)

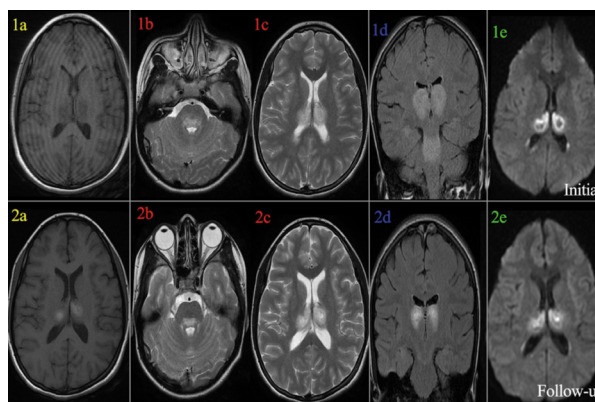

Case 3 initial(1) & 2 w follow up(2) MRI show low SI in both thalami in T1(1a) with follow up evidence of hemorrhage(2a). Initial(1b,1c) & follow up(2b,2c) T2 show high SI in the thalami and brain stem, same as in FLAIR(1d,2d). Initial (1e) & follow up (2e) DWI show peripheral concentric high SI & central low SI.

Conclusion: In conclusion, although ANE is a rare disease, it is a devastating disease that should not be underestimated.

Disclosure: Nothing to disclose

EPR3056

Inclusion of mechanical ventilation in severity staging of tuberculous meningitis improves outcome prediction

J. Kalita¹, U.K. Misra¹, V.K. Singh², P. Pandey¹, J. Thomas³

¹NEUROLOGY, Sanjay Gandhi Post Graduate Institute of Medical Sciences, LUCKNOW, India, ²Neurology, Sanjay Gandhi Post Graduate Institute of Medical Sciences, Lucknow, India, ³NEUROLOGY, Sanjay Gandhi Post Graduate Institute of Medical Sciences, Lucknow, India

Background and aims: Tuberculous meningitis (TBM) patients in any stage of British Medical Research Council (BMRC) scale if need mechanical ventilation (MV) are likely to have poor outcome. We report usefulness of BMRC, BMRC–MV and BMRC–HC (hydrocephalus) staging, and HAMSI scoring in predicting outcome of TBM
Methods: 197 TBM patients were retrospectively analyzed from a TBM registry of a teaching institute in India. The severity of meningitis was categorized using BMRC (stage I–III), BMRC–MV [I–IV (MV patients grouped as stage IV)] and BMRC–HC [I–IV (BMRC stage III with hydrocephalus grouped as stage IV)]. HAMSI scoring was categorized as <6 and >6. Outcome was defined at 6 months using modified Rankin Scale (mRS) as death, poor (mRS score >2) or good (mRS<2).

Results: 49 (25%) patients died. BMRC–MV stage IV had the highest predictive value for defining death with a sensitivity of 88% and specificity of 86%. 121 out of 158 (76.6%) surviving patients had good outcome at 6 months. BMRC–MV stage I–III had the highest predictive value for defining good outcome with a sensitivity of 93% and specificity of 61%.

Conclusion: In TBM, BMRC–MV staging has the best predictive value for defining death and disability

Disclosure: Nothing to disclose

EPR3057

Clinical characteristics, prognostic factors, and causes of death in adults with community-acquired pneumococcal meningitis

D. Koelman¹, M.C. Brouwer¹, L. Ter Horst¹, M. Bijlsma¹, A. Van der Ende², D. Van de Beek¹

¹Department of Neurology, Amsterdam UMC, University of Amsterdam, Amsterdam, Netherlands, ²Department of Medical Microbiology, Netherlands Reference Laboratory for Bacterial Meningitis, Amsterdam UMC, University of Amsterdam, Amsterdam, Netherlands

Background and aims: We evaluated the clinical characteristics, prognostic factors, and cause of death in adult pneumococcal meningitis.

Methods: We included adults (≥16 years) with community-acquired pneumococcal meningitis from 2 large nationwide prospective cohort studies in the Netherlands (1998–2002, 2006–2018). Deaths were categorized independently by 2 physicians as neurologic or systemic. Missing data were imputed to perform a multivariable logistic regression analysis.

Results: A total of 1816 episodes in 1783 patients were included (median age 62, IQR 51–70). 11 of 336 (3%) patients between 1998–2002 and 1177 of 1437 patients (82%) between 2006–2018 received adjunctive dexamethasone. 363 patients (20%) died, 192 due to neurologic cause (54%; e.g. brain herniation (n=78)) and 166 due to systemic cause (46%; e.g. cardiorespiratory failure (n=72)). In patients ≥75 years old, mortality rate was 43%, and more commonly due to systemic causes compared to younger patients (63% vs. 39%, p<0.001). Dexamethasone treatment was associated with a lower rate of focal neurological abnormalities (19% vs. 25%, p=0.006), cardiorespiratory failure (28% vs. 41%, p<0.001), and mortality (30% vs. 15%, p<0.001). Dexamethasone decreased both neurologic (15% vs. 9%) and systemic causes of death (15% vs. 6%). Age ≥75 years, immunocompromising condition, higher heart rate, lower Glasgow Coma Scale score, cranial nerve palsy, CSF white cells <1,000/μL, CSF:blood glucose ratio <0.23, C-reactive protein >200mg/L, and thrombocytes <75,000units/L were associated with mortality in a multivariable model.

Conclusion: Pneumococcal meningitis is still associated with high mortality and morbidity rates. Death due to systemic causes increased with age.

Disclosure: Nothing to disclose

EPR3058

Withdrawn

EPR3059

Chorea and pancerebellar syndrome caused by cerebrospinal fluid HIV escape

D. Pereira¹, V. Oliveira¹, H. Dória², M. Marques³, A.P. Tavares³, E. Santos¹

¹Neurology, Centro Hospitalar Universitário do Porto – Hospital de Santo António (CHUP-HSA), Porto, Portugal, ²Neuroradiology, Centro Hospitalar Universitário do Porto – Hospital de Santo António, Porto, Portugal, ³Infectious Diseases, Hospital de Santo António, Porto, Portugal

Background and aims: HIV neurotropism is one of the main problems associated to HIV infection. Central nervous system (CNS) is an ideal reservoir. Despite antiretroviral treatment, there could be direct lesion in the CNS caused by the virus, due to cerebrospinal fluid (CSF) HIV escape phenomena, which can be defined by duplication of the viral load in CSF with blood viral load of 50-500/ml.

Methods: Case report.

Results: 51-year-old man, HIV positive discovered in 2008. The patient started antiretroviral therapy (ART) with emtricitabine-tenofovir and raltegravir in 2009. Through years of consultations, no viral suppression was achieved (mean blood viral load of 200/ml), partially related to suboptimal therapeutic adherence. He was evaluated in early 2019 for chorea and pancerebellar syndrome, with mnemonic and behavioral impairment with 5 months progression. MRI revealed diffuse leukoencephalopathy. CSF analysis showed 12 cells (90% mononuclear) and viral load of 1600/ml (blood viral load of 228/mL) suggestive of CSF HIV escape phenomena. Other causes for neurologic symptoms were excluded. Test for antiretroviral therapy (ART) showed moderate to high levels of resistance. Therapeutics were changed for darunavir/cobicistat + dolutegravir. For symptomatic control, he also started a low dosage of haloperidol. Progressive clinical improvement was noticed after 2 weeks.

Conclusion: We described a rare case of chorea and cerebellar syndrome secondary to HIV escape in CSF. Here we can see two causes that contributed to the escape phenomena: non-adherence to therapy and resistance to ART.

Disclosure: Nothing to disclose

EPR3060

A systematic literature review to identify the named outcome measures used in the long-term follow up of encephalitis

H. Van Den Tooren¹, A. Easton², C. Hooper³, J. Mullin⁴, T. Solomon⁵, B. Michael⁶

¹Hull, ²Malton, ³Institute of Infection and Global Health, University of Liverpool, Liverpool, United Kingdom, ⁴Department of Neuropsychology, The Walton Centre, Liverpool, United Kingdom, ⁵Liverpool, United Kingdom, ⁶The Walton Centre, Liverpool, United Kingdom

Background and aims: Encephalitis is inflammation of the brain caused by infection or autoimmunity, from which most patients don't fully recover. Drawing conclusions in this field has been challenging due to the breadth of outcome measures used, which creates heterogeneous data across studies. This review details the outcome measures used in studying the long-term outcomes of encephalitis and will determine if these align with those that are important to patients.

Methods: A systematic literature review has been performed using Cochrane Library, Web of Science, Embase, PubMed, MEDLINE and CINAHL in June 2019. A single reviewer screened titles, abstracts and determined if shortlisted full-text articles met the inclusion criteria. Key data was collected from the included papers which has been included in a narrative summary.

Results: A total of 35 papers were included, in which 37 named outcome measures were assessed in a total of 3,133 patients. These broadly fall into five categories: physical, cognitive, mood, quality of life, and functional outcomes. The outcome measures used on most patients were Modified Rankin Score (mRS), Glasgow Outcome Score (GOS), Barthel index and Euro-QoL-5D, which were all used on over 1,000 patients each.

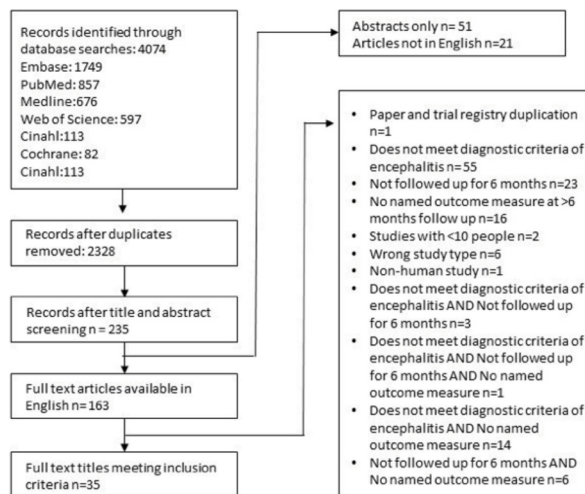

Prisma flow chart outlining the selection process for included articles.

Conclusion: Many variable outcome measures are used in encephalitis research and many assess narrow problems.

Excluding the Liverpool Outcome Score, the outcome measures used are not validated in encephalitis. Future research should focus on validating the outcome measures in use and developing a core-outcomes set or a composite outcome measure that assesses all important outcome domains to both clinicians and patients.

Disclosure: Nothing to disclose

EPR3061

Cerebrospinal fluid culture yield and timing of antibiotic treatment in patients with acute community-acquired bacterial meningitis

I. Van Zeggeren, L. Ter Horst, D. Van de Beek, M.C. Brouwer
Neurology, Amsterdam UMC, University of Amsterdam, Amsterdam, Netherlands

Background and aims: Bacterial meningitis is a severe disease which requires timely diagnosis and treatment. We evaluated the association between timing of lumbar puncture and antibiotic treatment with respect to diagnostic yield in patients with community-acquired bacterial meningitis.

Methods: Adult patients (≥ 16 years) presenting to the emergency department who underwent a lumbar puncture for the suspicion of a central nervous system infection, included in 2 prospective cohort studies (2012-2015 single center study; 2017-2019 multi-center study), were analyzed. Bacterial meningitis was diagnosed based on microbiological evidence, or scored independently by 2 neurologists based on available clinical data.

Results: Of the 554 episodes included, 54 (10%) were clinically diagnosed with bacterial meningitis of whom 41 (76%) had an individual predictor of bacterial meningitis. Cerebrospinal fluid (CSF) culture remained negative in 33 episodes (61%). CSF PCR identified the pathogen in 5 additional episodes and blood culture in an additional 17 episodes, resulting in 17 (32%) bacterial meningitis patients without proven causative pathogen. A greater amount of time between the start of antibiotic treatment and lumbar puncture was associated with higher rate of negative CSF culture ($p=0.007$). CSF culture was positive in 89% if the lumbar puncture was performed within 1 hour, in 40% if performed between 1-6 hours, and in 33% if performed after 6 hours (tertiles, $p=0.034$).

Conclusion: Timing of antibiotic treatment prior to lumbar puncture is associated with the yield of CSF cultures. Results stress the importance of early lumbar puncture in patients with suspected central nervous system infection.

Disclosure: Nothing to disclose

Movement disorders 5

EPR3062

Clinical phenotyping and ethnicity: observational study of White and Asian population in the United Kingdom

A. Sauerbier¹, A.E. Schrag², R. Brown³, P. Martinez-Martin⁴, D. Aarsland⁵, N. Mullholland⁶, G. Vivian⁷, H. Dafsari¹, A. Rizos⁸, B. Corcoran⁷, J. Jarosz⁹, L. Siakallis⁹, K. Ray Chaudhuri²

¹Uniklinik Köln, Cologne, Germany, ²London, ³Psychology, King's College London, Institute of Psychiatry, Psychology & Neuroscience, London, United Kingdom, ⁴Madrid, Spain, ⁵London, United Kingdom, ⁶Department of Nuclear Medicine, King's College Hospital, London, United Kingdom, ⁷Nuclear Medicine, King's College Hospital, London, United Kingdom, ⁸Department of Neurology, King's College Hospital, London, United Kingdom, ⁹King's College hospital, London, United Kingdom

Background and aims: Ethnicity may be associated with different presentation of Parkinson's disease (PD) related to genetic, epigenetic, environmental, cultural and socioeconomic factors.

Methods: Therefore, in this cross-sectional multicenter study across London from a multi-ethnic PD population clinical profiles between Asian and White PD Patients were explored using a range of PD stage (Hoehn and Yahr, HY), motor function (Scopa-Motor), Nonmotor symptoms Scale (NMSS), and relevant biomarkers (MRI and DaTSCAN imaging).

Results: In total 146 White (58.9% males, age 67.2±12.7 years) and 54 Asian (66.7% males, age 66.4±11.4 years) patients were evaluated. There were no significant differences between the White and Asian population in terms of age, gender, disease duration, age at PD onset, Hoehn and Yahr and Levodopa Equivalent Daily Dose. Asians however had higher comorbidity (in particular arterial hypertension (46.3% versus 27.6%, $p < 0.05$) as well as greater motor impairment (SCOPA-Motor Scale Total 16.5±9.1 versus 21.0±11.4, $p = 0.008$) and worse overall non-motor burden on the NMSS scale (36.4±29.5 versus 62.0±52.8; $p = 0.016$). There were no differences in the burden of white matter changes on MRI scans. Dopamine receptor presynaptic imaging data suggested equivalent reduction on DaTSCAN uptake in the two groups.

Conclusion: Our data suggest higher disease burden, both from a motor and non-motor point of view in Asian patients with PD, and higher rates of comorbidity, which underlie these differences at least partly. The findings lay out grounds for a large-scale multicentre cohort study with a focus on specific biomarkers and ethnicity.

Disclosure: Parkinson's UK grant Kirby Laing grant

EPR3063

Transcranial direct current stimulation (tDCS) on PD patients with freezing of gait: a kinematic evaluation

S. Scalise¹, G. Di Lazzaro¹, M. Al-Wardat¹, T. Schirinzi¹, N.B. Mercuri¹, M. Patera¹, L. Pietrosanti², M. Ricci², G. Saggio², A. Pisani¹

¹Department of Systems Medicine, University Hospital of Rome Tor Vergata, Rome, Italy, ²Department of Electronic Engineering, University of Rome Tor Vergata, Rome, Italy

Background and aims: Freezing of gait (FOG) is one of the most disabling complication of Parkinson's disease (PD), being not only a motor problem but also arising from deficit in executive functions. Aim of our study is to evaluate the effectiveness of anodal tDCS of the dorsolateral prefrontal cortex (DLPFC) in PD patients presenting FOG. To avoid the rater score variability and the underrating of motor performance, we used Technology-based objective measures to evaluate the treatment response.

Methods: 10 patients underwent 20 minutes of electric current of 2mA on 10 separate visits. Unified Parkinson's Disease Rating Scale pars 2-3 (UPDRSII-III), Hoehn and Yahr (H&Y), New Freezing of Gait Questionnaire (N-FOGQ), Berg Balance Scale (BBS) were performed at baseline (T0), after last stimulation (T1) and at one-month follow-up (T2). Moreover, kinematic parameters of gait abnormalities were measured by means of wearable devices (MOVIT G1®) in order to obtain an objective evaluation.



Wearable devices's position

Results: Our preliminary results demonstrate a significant clinical improvement in the disturbance of balance and the severity of FOG episodes. The kinematic evaluation shows an improvement in parameters that measures number and duration of steps and velocity of legs and thighs. Furthermore, a high correlation is found between the amelioration of clinical and kinematic features.

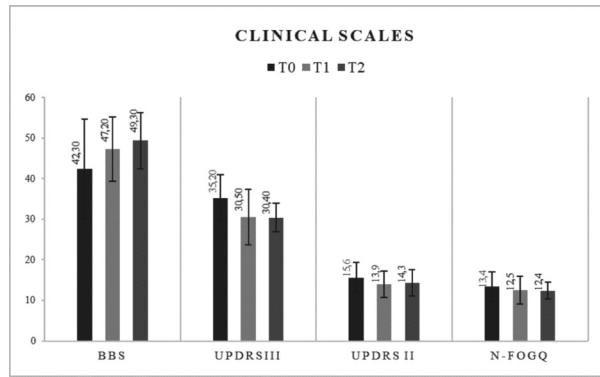

Improvement in clinical scales

Kinematic features	Clinical item	ρ	p-value
TUG Test duration	UPDRSIII - Gait	0.52953068	0.00261942
TUG Walk duration	UPDRSIII - Gait	0.54234132	0.00196099
TUG Turn duration	UPDRSIII - Gait	0.51061797	0.00393683
TUG Average velocity thigh	UPDRSIII - Gait	-0.4247443	0.01930551
TUG Average velocity leg	UPDRSIII - Gait	-0.40529134	0.02629177
TUG Average velocity turn	UPDRSIII - Gait	-0.62640631	0.00021293
NW Step velocity	UPDRSIII - Gait	-0.38605316	0.03510726

Correlation between kinematic and clinical features (Spearman test)

Conclusion: Coherently with the hypothesis that cognitive executive circuit plays a role in FOG, we may consider anodal tDCS of the DLPFC as a potential adjunctive therapy in PD patients with FOG and disturbance of balance. Moreover, wearable devices can objectively quantifying a possible beneficial effect of a therapeutic intervention.

Disclosure: Nothing to disclose

EPR3064

The role of the London Handicap Scale in the evaluation of Parkinson's Disease patients before and after DBS-STN

D. Silva¹, M. Fabbri², L. Guedes¹, A.C. Caldas³, P. Pita Lobo¹, B. Cattoni⁴, H. Carvalho⁴, A. Gonçalves Ferreira⁴, M.M. Rosa¹, J. Ferreira⁵, M. Coelho¹

¹Department of Neurosciences and Mental Health, Centro Hospitalar Universitário Lisboa Norte, Hospital de Santa Maria, Lisbon, Portugal, ²Department of Neuroscience, University of Turin, Turin, Italy, ³Centro Neurológico Sénior, Torres Vedras, Portugal, ⁴Department of Neurosurgery, Hospital de Santa Maria, Lisbon, Portugal, ⁵Neurological Clinical Research Unit, Instituto de Medicina Molecular, Lisbon, Portugal

Background and aims: The London Handicap Scale (LHS) is a good measure of perceived-health status in PD. Handicap increases with disease duration and severity, and the identification of the affected subdomains at each disease stage may allow to adapt therapeutic interventions accordingly. Our aim was to characterize the handicap after 4.8years of DBS-STN.

Methods: 33 PD patients submitted to DBS-STN were evaluated after a mean of 4.8 years of surgery in 4 conditions (stimOFF/medOFF, stimON/medOFF, stimOFF/medON, stimON/medON), using MDS-UPDRS, HY and SE. Handicap (maximum LHS=0) and nonmotor symptoms (NMSS, NPI, MMSE, GDS), QoL (PDQ-8, EQ-5D) were also characterized.

Results: Mean age and age at DBS were 64.3 (\pm 9.9) and 59.4 (\pm 9.6)years, respectively. Median HY was 2 and median SE 90 (IQR,70-90). 78.8% of patients had independent gait.

Mean LHS score (4.8 years DBS-STN) was 0.707(\pm 0.207) and the most affected domains were Occupation, Mobility and Social Integration. Handicap was significantly correlated with age ($r=-0.358$), age at DBS ($r=-0.429$), independent gait ($r=0.600$), MDS-UPDRS-II ($r=-0.568$), MDS-UPDRS-I ($r=-0.527$), MDS-UPDRS-III ($r=-0.426$), SE ($r=0.562$), nonmotor symptoms(NMSS) ($r=-0.503$), depression (GDS) ($r=-0.491$), PDQ-8 ($r=-0.667$) and EQ-5D ($r=0.657$) (all $p<0.05$). Functional (SE) and gait dependence and depression were the independent predictors of handicap (adjusted $R^2=0.600$; $p=0.010$).

In a sample of 18 patients with LHS evaluation before and after surgery, handicap significantly improved after DBS [Δ LHS 0.213(\pm 0.185); $p=0.002$].

Conclusion: PD patients submitted to DBS-STN were mildly handicapped 5 years after surgery, which was determined by functional and gait dependency, and depression. The affected subdomains were Occupation, Mobility and Social integration. Compared to pre-DBS, handicap was still better after 5 years of surgery.

Disclosure: Nothing to disclose

EPR3065

Probabilistic response mapping in a cohort of mixed dystonia patients.

C. Soares¹, M. Reich², F. Costa³, J. Roothans², R. Vaz⁴, M.J. Rosas¹, J. Volkmann⁶

¹Neurology, Centro Hospitalar Universitário de São João, Porto, Portugal, ²Neurology, Julius-Maximilians-University Würzburg, Würzburg, Germany, ³Neuroradiology, Centro Hospitalar Universitário de São João, Porto, Portugal, ⁴Neurosurgery, Centro Hospitalar Universitário de São João, Porto, Portugal, ⁵Neurology, University Hospital Würzburg, Würzburg, Germany

Background and aims: Probabilistic outcome brain mapping is a promising tool to estimate the expected benefit of pallidal deep brain stimulation (DBS-GPi) in patients with dystonia. However, its validity and feasibility for isolated and combined dystonia needs to be established.

Methods: Registration of atlas, detection of leads and rendering of volume of tissue activated (VTA) were performed for each patient with generalized and cervical isolated or combined dystonia that underwent bilateral DBS-GPi between 2005-2015. Each patient-specific VTA was associated with the clinical improvement (percentage of dystonia score reduction). The correlation between predicted and real clinical benefit based on a VTA-atlas model was studied.

Results: We enrolled 21 patients with a mean follow-up of 3 years. Subjects with cervical dystonia had a superior clinical benefit on follow-up, but these results were not statistically significant (78% vs 62%, $p=0.098$). The proportion of non-responders was 9.4% and 24% patients had an excellent response (more than 80% of motor benefit) at 3-years follow-up. The volume with highest probability of good outcome was located within the ventroposterior GPi and adjacent subpallidal white matter. A correlation between real clinical improvement and the VTA-atlas model estimation was found. Considering clinical and demographic variables, we are able to explain 32% of the observed variance in DBS response according to this model ($r^2=0.32$; $P=0.042$).

Conclusion: There is a correlation between observed and predicted clinical improvement based on VTA-atlas model. These results emphasize the potential of probabilistic outcome brain mapping in refining the optimal therapeutic volume for pallidal neurostimulation.

Disclosure: Nothing to disclose

EPR3066

Progression of brain cholinergic dysfunction in patients with isolated REM sleep behavior disorder. A 11C-Donepezil PET study.

K. Stær¹, A. Iranzo Riquer², M. Stokholm¹, K. Østergaard¹, M. Serradell³, M. Otto⁴, K.B. Svendsen⁵, A. Garrido⁶, D. Vilas Rolan⁷, J. Santamaria⁸, A. Møller¹, C. Gaig⁷, D.J. Brooks⁹, P. Borghammer⁹, E. Tolosa¹⁰, N. Pavese¹¹

¹Aarhus University, Aarhus, Denmark, ²Madrid, Spain, ³Department of Neurology, Hospital Clinic de Barcelona, Barcelona, Spain, ⁴Risskov, Denmark, ⁵Aarhus C, Denmark, ⁶Hospital Clinic de Barcelona, Barcelona, Spain, ⁷Barcelona, Spain, ⁸University of Barcelona, Barcelona, Spain, ⁹Department of Nuclear Medicine and PET-Centre, Aarhus University Hospital, Aarhus C, Denmark, ¹⁰Parkinson Disease Research IDIBAPS, University of Barcelona, Barcelona, Spain, ¹¹Neurosciences, University of Newcastle, Newcastle Upon Tyne, United Kingdom

Background and aims: Isolated REM sleep behavior disorder (iRBD) is widely considered a prodromal stage of parkinsonism, and we have previously reported the presence of reduced acetylcholinesterase activity, as measured by 11C-Donepezil PET, in the cortex but not in the basal ganglia of iRBD patients with no cognitive deficits. In this longitudinal study, we aimed to explore the temporal changes in acetylcholinesterase activity in the brains of iRBD patients.

Methods: We studied 11 polysomnography-confirmed iRBD patients with 11C-Donepezil PET, a marker of cholinergic function, twice over a 3-year period. The PXmod module of PMOD software 3.6 (PMOD technologies Ltd. Switzerland) was used to generate binding potential (BPND) images, using the Logan Reference Tissue model. The follow-up images were compared to the baseline images at a voxel level using Statistical Parametric Mapping (SPM) 12 (FIL Methods Group).

Results: The SPM analysis showed significant reduction ($p<0.04$, FWE corrected) in acetylcholinesterase activity from baseline to follow-up in the iRBD patients in several cortical regions (the frontal, parietal and occipital lobes, and the left temporal lobe), but also in both thalami as well as striatal areas of both hemispheres.

Conclusion: Our results suggest that the severity and extent of cholinergic dysfunction in the brains of iRBD patients increase significantly over a 3-year period. However, the clinical correlates of these changes remain to be investigated.

Disclosure: Nothing to disclose

EPR3067

Pre-motor manifestations, including psychotic features, in a rat model of Parkinson's disease based on human alpha-synuclein overexpression

A. Polissidis¹, V. Kollia¹, M. Koronaiou¹, F. Koronaiou¹, M. Nakos-Mpimpos¹, M. Boyongo¹, S. Vrettou¹, N. Casadei², O. Riess², M. Xilouri¹, L. Stefanis³
¹*Translational Research, Biomedical Research Foundation of the Academy of Athens, Athens, Greece,* ²*Human Genetics, University of Tübingen, Tübingen, Germany,* ³*Neurology, National and Kapodistrian University of Athens, Athens, Greece*

Background and aims: Amongst the non-motor symptoms of Parkinson's Disease (PD), neuropsychiatric, in particular psychotic manifestations, are amongst the most debilitating. Progress in understanding their pathophysiological basis, as well as their management, has been slow, in part due to the absence of relevant animal models.

Methods: Using humanized BAC transgenic alpha-synuclein (AS) rats (Nuber et al., 2013), we assessed motor function with the Beam Traversal and Footprinting tests; cognition with the Morris Water Maze test, mood with the Forced Swim and the sucrose preference tests, olfactory function with the buried pellet test, anxiety-like behavior with elevated plus-maze, and psychotic-like behavior with Prepulse Inhibition and locomotor activity in a novel environment. Fractionated Western immunoblotting was used to assess AS brain deposition, HPLC to assess striatal Dopamine levels and immunohistochemistry to assess dopaminergic neurodegeneration.

Results: AS BAC Tg rats manifested a pre-motor PD-like phenotype with age-dependent olfactory and cognitive deficits, as well as depressive behaviors. The most outstanding phenotype consisted of a psychosis-like profile, including an early and persistent hyperactivity in a novel environment that was reversed by antipsychotics, as well as a late-onset sensorimotor gating deficit, associated with a striatal hyperdopaminergic state. This neuropsychiatric phenotype was accompanied by an abundance of brain region-dependent aberrant AS aggregation pathology.

Conclusion: Our findings provide insight into region-specific perturbations that precede motor manifestations and support a role of an AS-mediated striatal hyperdopaminergic state in the generation of psychotic-like features prior to neurodegenerative phenocconversion. This situation has analogies to PD, where recent findings suggest that a premotor hyperdopaminergic state may occur.

Disclosure: Funded in part by grants MULTISYN (FP7, European Commission) to LS and ELIDEK grant (Greek Secretariat of Research and Technology) to AP

EPR3068

RFC1 intronic repeat expansions in multiple systems atrophy

R. Sullivan¹, W.Y. Yau², V. Chelban³, S. Rossi⁴, E. O'connor⁵, N.W. Wood², A. Cortese⁶, H. Houlden⁷
¹*Neuromuscular Diseases, UCL, London, United Kingdom,* ²*UCL Institute of Neurology, London, United Kingdom,* ³*Department of Neurodegenerative Disease, UCL Institute of Neurology, National Hospital For Neurology and Neurosurgery, London, ,* ⁴*Neurology, Fondazione Policlinico Universitario A. Gemelli IRCSS, Rome, Italy,* ⁵*Department of molecular neuroscience, UCL Institute of Neurology, London, United Kingdom,* ⁶*PAVIA, Italy,* ⁷*London,*

Introduction: Multiple Systems Atrophy (MSA) is difficult to diagnose in the early stages due to the clinical overlap of late-onset ataxia with autonomic features and MSA with cerebellar predominance and parkinsonian predominant phenotypes. With the recent identification of recessive, intronic repeat expansions in the RFC1 gene as a cause of late-onset ataxia, neuropathy, vestibular areflexia syndrome we hypothesised that there could be an overlap with the early stages of MSA or with atypical MSA and additional clinical features.

Methods: 2 MSA cohorts were investigated; 336 pathologically confirmed brain bank cases and 207 clinically diagnosed probable or possible MSA cases, both diagnosed according to MSA consensus criteria. These underwent genetic analysis and Southern blot confirmation of RFC1 expansions.

Results: 2 clinically diagnosed probable MSA cases were biallelic for the RFC1 expansion. They presented with typical rapid, progressive history and clinical features for MSA including progressive cerebellar ataxia, parkinsonism, autonomic dysfunction, but both also had a mild sensory neuropathy. No biallelic repeat expansions were identified in the pathologically confirmed MSA cohort.

Conclusion: We report that the clinical features of early MSA may overlap with RFC1 associated ataxia. We recommend adding RCF1 analysis to the initial screening of MSA patients, particularly those with an unusual phenotype, with a possible family history or any clinical signs of a peripheral neuropathy. With the advent of MSA therapeutic trials, initial screening to exclude other causes will be paramount to achieve the most accurate outcome.

Disclosure: Nothing to disclose

EPR3069

Long-term effectiveness and medication patterns (monotherapy vs polytherapy) with device-aided therapies: A retrospective analysis of an Israeli cohort of patients with advanced Parkinson's disease

A. Thaler¹, N. Giladi², Y. Barer³, R. Gross⁴, R. Cohen⁴, L. Bergmann⁵, Y. Jalundhwal⁵, G. Chodick⁶, V. Shalev³, T. Gurevich²

¹Neurological Institute, Tel Aviv Sourasky Medical Center; Sackler School of Medicine, Tel Aviv University; Sagol School of Neuroscience, Tel Aviv University, Tel Aviv, Israel, ²Tel Aviv Sourasky Medical Center, Tel Aviv, Israel, ³Maccabi Institute for Research & Innovation, Tel Aviv, Israel, ⁴AbbVie Inc, Hod Hasharon, Israel, ⁵AbbVie Inc, North Chicago, USA, ⁶Maccabi Institute for Research & Innovation; School of Public Health, Tel Aviv University, Tel Aviv, Israel

Background and aims: As Parkinson's disease (PD) progresses, some patients may not be adequately controlled with oral dopaminergic medication and may require device-aided therapies (DATs) such as levodopa-carbidopa intestinal gel (LCIG), continuous subcutaneous apomorphine infusion (CSAI), and deep brain stimulation (DBS). This study investigated treatment duration of LCIG vs CSAI, and medication patterns (mono- and combination therapies).

Methods: This retrospective cohort study used the Maccabi Healthcare Services database and identified advanced PD patients (≥18 years) treated with DATs since September 2009. Patients were excluded if they had <12 months of potential follow-up. Outcomes included treatment duration at 12 months, treatment persistence up to 60 months, and comedication profiles. Descriptive statistics were used.

Results: Of 161 patients identified (Table), LCIG had greater mean persistence rate (12 months: 87.0%; 36 months 81.5%) vs CSAI (12 months: 81.4%; 36 months: 59.4%) (Figure 1). Over the study, mean (95% CI) time to discontinuation (including death) for LCIG was 86.4 (73.3–99.6) months and 42.4 (27.7–57.1) months for CSAI (P=.046). There was a medication profile shift, with approximately half of patients in each group taking ≥4 PD medications before DAT initiation, whereas at last measurement, more patients had LCIG as monotherapy (LCIG: 29%; DBS: 13%; CSAI: 6%) or LCIG with only additional nighttime controlled-release levodopa (LCIG: 45%; DBS: 23%; CSAI: 12%) (Table, Figure 2).

Table. Patient Baseline Characteristics

Characteristic	LCIG (n = 62)	DBS (n = 76)	CSAI (n = 23)
Sex, n (%)			
Male	38 (61)	48 (63)	15 (65)
Age at PD diagnosis, years, median (IQR)	58.1 (49.5 – 66.4)	55.4 (49.8 – 61.7)	59.9 (55.9 – 67.0)
Age at DAT initiation, years, median (IQR)	69.4 (59.7 – 76.9)	65.3 (59.2 – 68.3)	68.9 (63.7 – 79.6)
Number of PD medications*			
0	1 (1.6)	2 (2.6)	—
1	5 (8.1)	6 (7.9)	2 (8.7)
2	7 (11.3)	16 (21.1)	6 (26.1)
3	13 (21.0)	14 (18.4)	2 (8.7)
≥ 4	36 (58.1)	38 (50.0)	13 (56.5)

Includes oral levodopa. CSAI, continuous subcutaneous apomorphine infusion; DAT, device-aided treatment; DBS, deep brain stimulation; IQR, interquartile range; LCIG, levodopa-carbidopa intestinal gel; PD, Parkinson's disease.

Figure 1

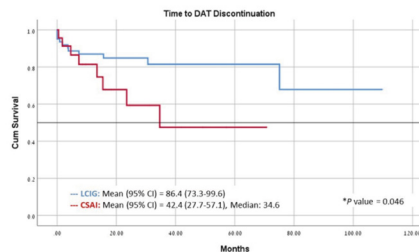
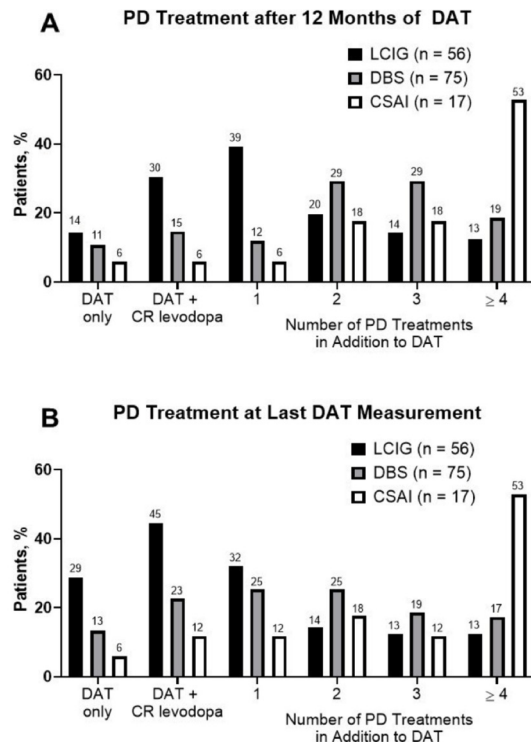

Figure 2



CR, controlled-release; CSAI, continuous subcutaneous apomorphine infusion; DAT, device-aided therapy; DBS, deep brain stimulation; LCIG, levodopa-carbidopa intestinal gel; PD, Parkinson's disease.

Conclusion: LCIG treatment was associated with higher persistence rates after 12 months and in the long-term vs CSAI. A higher proportion of patients on LCIG were on monotherapy vs DBS and CSAI.

Disclosure: AbbVie funded the research for this study and provided writing support for this abstract. Medical writing assistance, funded by AbbVie, was provided by Kelly M Cameron, PhD, CMPP™, of JB Ashtin.

EPR3070

Burden of Care-Partners of People with Parkinson's disease: Findings from Parkinson's disease Real-World Impact Assessment (PRISM) Study

E. Tolosa¹, J.J. Ferreira², A. Antonini³, A. Lees⁴, T. Foltynie⁴, G. Ebersbach⁵, O. Rascol⁶, J.-F. Rocha⁷, D. Magalhães⁷, P. Soares-Da-Silva⁸

¹Parkinson Disease and Movement Disorder Unit, Hospital Clinic, University of Barcelona, Barcelona, Spain,

²Laboratory of Clinical Pharmacology and Therapeutics, Faculty of Medicine, University of Lisbon, Lisbon, Portugal,

³Department of Neurosciences, University of Padova, Padua, Italy, ⁴Department of Clinical and Movement Neurosciences, National Hospital for Neurology and Neurosurgery, London, United Kingdom, ⁵Movement Disorders Clinic, Beelitz Hospital, Beelitz, Germany, ⁶Department of Neurosciences and Clinical Pharmacology, University of Toulouse, Toulouse, France, ⁷Global Parkinson's Disease Department, BIAL - Portela & Ca S.A., Coronado, Portugal, ⁸Research and Development Department, BIAL - Portela & Ca S.A., Coronado, Portugal

Background and aims: The burden of care-partners of people with Parkinson's disease (PwP) is currently not well understood or reported. The PRISM study was a European survey of PwP and their care-partners. PRISM data on the characteristics and burden of the care-partners of PwP are presented here.

Methods: PRISM was a descriptive, exploratory, observational study with cross-sectional design, fielded through an online survey developed in collaboration with The Cure Parkinson's Trust (UK-based advocacy group) and an international scientific committee. Collecting data of PwP and their matched-samples care-partners through online channels may limit results interpretation. Care-partner burden was assessed using the Zarit Burden Inventory (ZBI). Multivariate analysis assessed associations between PwP/care-partner characteristics and ZBI total score.

Results: Between April-July 2019, data were collected from 256 care-partners of PwP from France, Germany, Italy, Portugal, Spain and the UK (Table). The majority of care-partners were female (65%) and partner/spouse to the PwP (82%). Care-partners spent a mean 22.5 hours/week caring for the PwP and the majority (55%) received no assistance from other caregivers. Care-partners reported mild-moderate burden (mean ZBI total score, 26.6); 72% reported that caring for PwP impacted their relationship, and 46% reported an impact on their sexual relationship. Multivariate analysis revealed that female care-partner gender, older PwP age, worse PwP's PDQ-39 mobility score, more PwP's non-motor symptoms, higher hours of care/week, and being a sibling care-partner were associated with higher care-partner burden (Figure).

Table. Characteristics and burden of care-partners of PwP

Characteristic	N=256
Female gender, %	65
Partner/spouse of PwP, %	82
Hours of care to PwP/week	
N	214
Mean (SD)	22.5 (24.6)
Median	14
ZBI total score*	
N	246
Mean (SD)	26.6 (17.6)
Median (range)	25 (0-83)
Burden severity by ZBI total score*	
N	246
Severe (ZBI total score >60), %	3
Moderate/severe (ZBI total score 41-60), %	20
Mild/moderate (ZBI score 21-40), %	34
Little/no burden (ZBI ≤20), %	43
Assistance from others in caring for PwP	
N	242
Family member, %	30
Friend, %	13
Paid nurse, %	3
Other paid caregiver, %	12
Severity of impact of caring for PwP on relationship	
N	239
Extreme, %	5
Very much, %	16
Moderate, %	25
Slight, %	24
Not at all, %	28

*Assessed over previous month. PD, Parkinson's disease; PwP, people with Parkinson's disease; SD, standard deviation; ZBI, Zarit Burden Inventory

Table

Figure. Multivariate analysis of variables associated with ZBI total score (previous month; N=236).

*Hours of care referenced to 0 hours of care. CI, confidence interval; CP, care-partner; NMSQuest, Non-Motor Symptoms Questionnaire; PDQ-39, Parkinson's Disease Questionnaire-39; PwP, patient with Parkinson's disease; ZBI, Zarit Burden Inventory

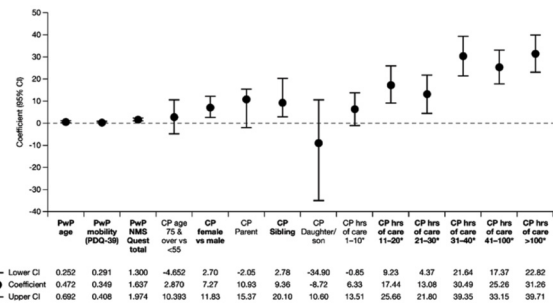

Figure

Conclusion: PRISM provides valuable information on meaningful factors affecting burden of care-partners in PD.

Disclosure: Study supported by Bial - Portela & C^a, S.A.

EPR3071

Possible effects of metformin therapy on motor and non-motor features of diabetic patients with Parkinson's disease (PD): an exploratory study using the Parkinson's Progression Markers Initiative (PPMI) cohort

C. Sportelli¹, D. Urso², J. Teo¹, K. Ray Chaudhuri²
¹King's College Hospital, London, United Kingdom,
²department of basic and clinical neurosciences, Institute of Psychiatry, Psychology, Psychiatry, Psychology & Neuroscience, King's College London, London, United Kingdom

Background: There is growing evidence for the benefits of metformin to counteract age-related diseases such as cancer, cardiovascular disease, and neurodegenerative diseases 1.

Objective: To evaluate the association between metformin treatment and the motor and non-motor clinical features among denovo PD patients with diabetes mellitus (DM).

Methods: This retrospective cohort study examined the effects of long-term metformin therapy (>2 years) on baseline PD clinical features among denovo PD patients with DM using the PPMI cohort. From the original PD cohort, 19 patients with a diagnosis of DM were selected and stratified into 2 groups: 1) Taking metformin for >2 years, 2) Not taking metformin. Additionally, we explored whether Metformin Cumulative Doses (Daily dose x years of treatment) could be associated with clinical features.

Statistical analysis: Categorical variables were expressed as proportions and compared using Fisher's test. Due to small group sizes, non-normal distribution of some variables, non-parametric tests (Chi-square, Mann-Whitney and Spearman correlation) were used for group comparisons and correlation analyses. The P-value<0.05 was considered statistically significant. Post-hoc correction for multiple comparisons was not applied given the exploratory nature of the study.

Results: DM patients taking Metformin showed lower baseline score in MDS-UPDRS total and performed better in Benton Judgment of Line Orientation, Symbol Digit Modalities and Semantic Fluency Total.

Conclusion: This observational analysis provides a soft footprint of metformin use and possibly better motor and cognitive scores in diabetic PD. Further studies of metformin in denovo or prodromal PD could provide a rationale for repurposing metformin.

Disclosure: Nothing to disclose

EPR3072

Independent domains of daily-life activity in patients with neurological gait disorders

M. Wuehr¹, A. Huppert², F. Schenkel³, R. Schniepp¹
¹Munich, Germany, ²Neurologie, Klinikum der Universität München, Munich, Germany, ³University of Munich, Munich, Germany

Background and aims: Alterations in daily-life activity and mobility are common in neurological patients. Quantitative assessment of daily-life mobility commonly yields a complex pattern of mobility measures that yet complicates clinical interpretability. Here, we applied factor analysis with the aim to classify clinical meaningful domains of daily mobility in patients with neurological gait disorders.

Methods: Daily-life activity and mobility of 315 individuals (55 healthy, 75 sensory ataxia, 78 cerebellar ataxia, 18 hypokinetic gait disorder, 51 vascular encephalopathy, 38 functional gait disorder) was recorded for two weeks using a wearable inertial sensor system (ActiPAL[®]). Principal component analysis (PCA) with varimax rotation was performed on 14 mobility parameters to derive 5 independent domains of daily mobility. Associations of domains with clinical motor, balance, cognitive, and quality of life scores was evaluated.

Results: 14 mobility parameters were included into PCA, which yielded 5 orthogonal factors accounting for 92.3% of total data variance. We characterized these factors as (I) Ambulatory Volume, (II) Ambulatory Pattern, (III) Sedentary Volume, (IV) Sedentary Pattern, and (V) Transitions. Factors showed differential, significant associations to clinical motor, balance, and cognitive scores.

Conclusion: These results support the approach of reducing the high dimensionality of real-world behavioral data to a small number of clinical meaningful macro-variables. This facilitation of the interpretation of quantitative mobility measures might further promote the application of such measures as clinical meaningful outcome parameters in medical science and clinical routine.

Disclosure: Nothing to disclose

EPR3073

The most impacting factors of Parkinson's disease patients' quality of life

I. Zhukova¹, N. Zhukova¹, E. Kolupaeva¹, O. Izhboldina¹, M. Nikitina¹, I. Mironova¹, A. Latipova¹, A. Agasheva², Z. Kisluhina¹, O. Guseva³, V. Rudenko⁴, O. Shakirova⁴

¹Neurology and Neurosurgery, Siberian State Medical University, Tomsk, Russian Federation, ²Hospital № 2, Tomsk, Russian Federation, ³Tomsk, Russian Federation, ⁴Siberian State Medical University, Tomsk, Russian Federation

Background and aims: Parkinson's disease (PD) is a neurodegenerative disorder characterized by motor and non-motor symptoms that collectively contribute to decreased Quality of Life (QoL).

The aim of the study is to identify the most impacting factors of Parkinson's disease patients' quality of life.

Methods: Clinical and neuropsychiatric assessments were studied by the Hoehn&Yahr (H&Y), UPDRS (III), MoCA-test, HADS, Beck depression inventory, Epworth Sleepiness Scale, Apathy Scale, SF-36, PDQ-39.

Results: Clinical assessment were based on 619 PD patients examination results: mean age: 68.13±9.32; mean PD duration: 6.8±4.6; women:men=380:239; H&Y stages 1–4. During the study were identified that most impacting factors of PD patients' QoL are depression, cognitive impairment, moto disfunction and levodopa induced dyskinesia.

Conclusion: Nevertheless, the lack correlations with disease-related variables gives us a suggestion that QoL may be individually impacted by other factors, indicating that an ideal patient-profile with regard to QoL improvement cannot be readily presented.

Disclosure: Nothing to disclose

MS and related disorders 7

EPR3074

Optical coherence tomography is sensitive for detecting asymptomatic optic nerve lesions in clinically isolated syndrome

O. Outteryck¹, R. Lopes², E. Drumez³, J. Labreuche³, J. Lannoy⁴, N. Hadhoum⁵, J. Boucher⁶, M. Zedet⁴, J.-P. Pruvo¹, H. Zéphir⁷, X. Leclerc¹

¹Neuroradiology, University of Lille, Lille, France,

²Department of Neuroradiology, Lille Nord de France

University, CHU Lille, Lille, France, ³Biostatistics,

University of Lille, Lille, France, ⁴Lille, France, ⁵Neurology,

CHRU Lille, Lille Cedex, France, ⁶Neurology, University of

Lille, Lille, France, ⁷Neurol, University of Lille, Lille,

France

Background and aims: To evaluate the ability of inter-eye retinal thickness difference (IETD) measured by optical coherence tomography (OCT) to detect asymptomatic optic nerve involvement in clinically isolated syndrome (CIS).

Methods: We conducted a cross-sectional study of patients who recently presented a CIS (≤ 4.5 months). All patients underwent an OCT and a brain/optic nerve MRI. Optic nerve involvement was defined clinically (episode of optic neuritis[ON] or not) and radiologically (optic nerve hypersignal on 3D-DIR). We evaluated the sensitivity (Se) and specificity (Sp) of IETD thresholds previously published and reported the observed optimal thresholds for identifying symptomatic optic nerve involvement but also for identifying asymptomatic optic nerve involvement (optic nerve hypersignal without ON history). Primary outcomes were ganglion-cells–inner-plexiform-layer (GCIPL) and peripapillary-retinal-nerve-fibers-layer (pRNFL) IETD.

Results: The study group consisted of 130 patients. In the CIS with ON group, 3D-DIR showed a hypersignal in all the 41 symptomatic optic nerves and in 11 asymptomatic optic nerves. In the CIS without ON group, 3D-DIR showed a unilateral optic nerve hypersignal in 22 patients and a bilateral optic nerve hypersignal in 7 patients. For the detection of symptomatic and asymptomatic optic nerve lesion, GCIPL-IETD had better performance. We found an optimal GCIPL-IETD threshold $\geq 2.82\mu\text{m}$ (Se=88.2%, Sp=83.3%) for the detection of symptomatic lesions and an optimal GCIPL-IETD $\geq 1.42\mu\text{m}$ (Se=89.3%, Sp=72.6%) for the detection of asymptomatic lesions.

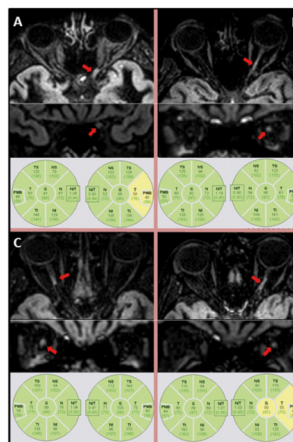

Figure: CIS patients without history of clinical optic neuritis presenting asymptomatic optic nerve lesion (red arrows) detected on 3D-Double-Inversion-Recovery MR sequence (on axial and coronal planes reconstruction) associated with their corresponding pRNFL thicknesses (A-D)

Figure Title: Optic nerve MRI and OCT findings in CIS patients without optic neuritis
 Figure Legend: CIS patients without history of clinical optic neuritis presenting asymptomatic optic nerve lesion (red arrows) detected on 3D-Double-Inversion-Recovery MR sequence associated with their corresponding pRNFL thicknesses (A-D)

Conclusion: Detection of asymptomatic optic nerve lesions at CIS requires lower IETD thresholds than previously reported. GCIPL-IETD represents an alternative biomarker to MRI for the detection of asymptomatic optic nerve lesion.

Disclosure: This work was supported by Bayer and Novartis. Bayer provided research funding for performing MRIs. Novartis provided research funding for the acquisition of the OCT device. Bayer and Novartis had no role in study design, data collection, analysis, interpretation, or writing of the report.

EPR3075

Epilepsy and pediatric multiple sclerosis

R. Papko, S. Kulikova, S.A. Likhachev, T. Svinkovskaya, S. Belaya, I. Kozyrava, S. Ivanov

Department Of Neurology, Republican Research and Clinical Center of Neurology and Neurosurgery, Minsk, Belarus

Background and aims: The incidence of epilepsy in multiple sclerosis (MS) is from 1.5 to 7.8%.

Methods: Were analyzed the incidence and features of epilepsy in patients with pediatric MS.

Results: 53 cases of pediatric MS were analyzed. 5 (9.43%) patients had epilepsy, all were girls. The average age of the MS onset was 13.98±2.9 years, of the seizures onset—15.2±2.9 years. In 3 cases, the seizures began after the MS diagnosis and were not during relapse. The EDSS score at the time of the epilepsy onset was: 1.5 (2 cases) and 3.0 (1 case). All children had a relapsing-remitting MS. In 2 cases, epilepsy started before the appearance of neurological symptoms, but the MRI has already revealed demyelinating lesions. At the time of the seizures onset, 3 patients did not receive DMT and 2 were treated by fingolimod. All patients had focal epilepsy: focal sensory attacks were in 3 cases, focal motor attacks—in 2, cognitive—in 1, behavior arrest in—1 and bilateral tonic-clonic—in 4. Epileptic status was not present in any case. EEG in all children recorded focal epileptic activity: in the frontal area in 1 case, frontal-temporal—1, frontal-central—1, frontal-central-temporal—in 1, central-parietal—1. Anticonvulsant therapy was effective in all: in 3 patients—Carbamazepine, in 1—Lamotrigine, in 1—Levetiracetam. In 1 patient, after withdrawal of therapy, seizures did not resume.

Conclusion: As epilepsy started before the MS onset and before DMT using in some patients, so seizures can be one of the clinical disease manifestations. Epilepsy in MS is focal and well treatable.

Disclosure: Nothing to disclose

EPR3076

Population-based comparative studies of the epidemiology of neuromyelitis optica spectrum disorder (NMOSD) in Europe

V. Papp¹, M. Magyari², N.J. Koch-Henriksen², K.D.P. Trones³, A.K. Iljicsov⁴, C. Rajda⁵, T. Petersen⁶, G. Lovas⁷, J.L. Frederiksen⁸, E. Stenager⁹, S. Komoly¹⁰, F. Sellebjerg¹¹, Z. Illes¹²

¹Aabyhøj, Denmark, ²Copenhagen, Denmark, ³Odense Medical University, Odense, Denmark, ⁴Budapest, Hungary, ⁵Szeged, Hungary, ⁶Department of Neurology, Aarhus University, Aarhus, Denmark, ⁷Department of Neurology, Ferenc Jahn South-Pest Hospital and Clinic, Budapest, Hungary, ⁸Glostrup, Denmark, ⁹University of Southern Denmark, Institute of regional health research, Sønderborg, Denmark, ¹⁰University of Pécs, Pécs, Hungary, ¹¹Danish Multiple Sclerosis Center, Copenhagen, Denmark, ¹²Department of Neurology and Institute of Clinical Research, Odense University Hospital, University of Southern Denmark, Odense, Denmark

Background and aims: Earlier studies suggested differences in prevalence and phenotype of NMOSD in people with different genetic background. No population-based comparative study is available among Caucasian populations. We investigated a potential geographical variation in prevalence and phenotype of NMOSD with aquaporin-4 antibody seropositivity (AQP4-Ab+) among two European populations.

Methods: We performed a large population-based comparative study involving the adult (age≥16) population of Denmark and Hungary. The study focused on AQP4-Ab+ Caucasian NMOSD patients. We utilized the same methodology and corresponding sources (databases, laboratories and neurology departments) to identify cases between 2007 and 2014 in both countries. Overlapping expert groups validated each case. We calculated prevalence based on 2015 IPND criteria. Mann–Whitney U and chi-squared/Fisher exact test were used.

Results: We identified 35 Danish and 99 Hungarian AQP4-Ab+ NMOSD cases. We found significantly higher prevalence in Hungary compared to Denmark on January 1, 2014 (1.39/100,000 [95%CI:1.11-1.71] vs 0.71/100,000 [95%CI:0.48-1.01]; p=0.0019) based on both 2015 IPND criteria. Optic neuritis was the most frequent onset attack in the Hungarian population (n=41 [41%] vs. n=6 [17%]; p=0.013) while transverse myelitis was the most common among Danish patients (n=21 [60%] vs. n=35 [35%]; p=0.009). The Danish cohort was more affected by spinal cord damages such as more frequent use of catheters, more severe EDSS score, more commonly bound to wheelchair/bed, and atrophy in the spinal cord.

Conclusion: These data support differences even among Caucasian populations in Europe and substantiate the need for genetic association studies in NMOSD.

Disclosure: The work was supported by the Economic Development and Innovation Operational Programme (GINOP-2.3.2-15-2016-00039), the Hungarian

Neuroimmunological Society, the Graduate School of Health, Aarhus University (grant no. 1591 8355); the Danish MS Society (Scleroseforeningen R458 – A31859, R431 – A29805). The funding organizations had no role in the design and conduct of the study; collection, management, analysis, and interpretation of the data; preparation, review, or approval of the manuscript; and decision to submit the manuscript for publication.

EPR3077

Theory of mind deficits across MS phenotypes

M. Pardini¹, E. Colombo², R. Meli², C. Lapucci², N. Bruschi², G. Boffa², M. Cellerino², E. Sbragia², A. Uccelli¹, M. Inglese¹

¹Department of Neurosciences, Rehabilitation, Ophthalmology, Genetics, Maternal and Child Health (DINOEMI), University of Genoa and IRCCS Policlinico San Martino, Genoa, Genova, Italy, ²Department of Neuroscience, Rehabilitation, Ophthalmology, Genetics, Maternal and Child Health (DiNOEMI), University of Genoa, Italy, Genova, Italy

Background and aims: Theory of Mind deficits (ToM, the ability to decode emotional states) have been described in patients with Multiple Sclerosis (MS). ToM assessment is not included in neuropsychological evaluations of MS, and this is also due to an incomplete understanding of the relationship between general cognition and RMET across the disease stages

Methods: 90 MS patients (age: 44.8±10.7 years, median EDSS 2.0 range 1-6, 62 with relapsing remitting (RRMS) and 28 with progressive MS (PMS)) were assessed with the Symbol Digit Modalities Test (SDMT) to evaluate general cognition and the Reading the Mind in the Eyes Test (RMET) to evaluate ToM

Results: Comparing RRMS and PMS patients, there was a significant difference in SDMT (54.3±12.1 vs 41.3±11.2, p=0.001) and in total RMET (26.4±4.1 vs 23.5±3.2, p=0.03) scores; the difference in RMET performance lost significance after correction for SDMT (p=0.26). There was a significant correlation between SDMT and ToM in the whole sample (p<0.001, r=0.34) and in RRMS (p=0.001, r=0.434), but not in PMS (p=0.83)

Conclusion: The association between SDMT and RMET is modulated by clinical phenotype. RMET seems to probe a cognitive construct not included in the SDMT and thus should be included in the baseline evaluation of MS. The impact of clinical phenotype on the association between RMET and SDMT suggest that these 2 metrics change differently over the disease course and thus provide different vantage points to study cognition in MS.

Disclosure: Nothing to disclose

EPR3078

Gray Matter atrophy is mild in patients with long-term benign MS.

F. Parodi¹, R. Cortese¹, E. Prestipino², L. Razzolini², M.L. Stromillo¹, E. Portaccio³, M. Battaglini¹, A. Giorgio¹, M.P. Sormani⁴, M.P. Amato², N. De Stefano¹
¹Department of Medicine, Surgery and Neuroscience, University of Siena, Siena, Italy, ²Department of Neurological and Psychiatric sciences (NEUROFARBA), University of Florence, Florence, Italy, ³SOC Neurology, San Giovanni di Dio Hospital, Florence, Italy, ⁴Biostatistics Unit, University of Genoa, Genoa, Japan

Background: Whether or not multiple sclerosis (MS) can have a benign course (B-MS) is still controversial, however a small group of patients who are not disabled after many years of disease can be identified.

Aims: To identify whether brain damage is less pronounced in patients with long-term benign disease course.

Methods: We compared 13 patients defined as long-term B-MS (age >55 years, Expanded Disability Status Scale [EDSS] ≤ 3.0, after at least 30 years from disease onset) and 27 non-benign MS (age >55 years, EDSS >3.0). MRI scans (n= 116, on average 3 scans per patient) of both groups were assessed retrospectively (mean follow-up: 11 years, range: 8-13 years and similar between the 2 groups). Brain volumes (BV) and total T2-lesion volume (LV) changes over time were compared between the 2 groups using a mixed effect regression model.

Results: Over 11 years, patients with long-term B-MS showed less global BV and grey matter (GM) decreases (p for slope difference 0.02 and <0.001, respectively) than those with non-benign MS course. By contrast, there was no difference between the 2 groups in the accumulation of T2-LV (p= 0.76; see Table and Fig.1).

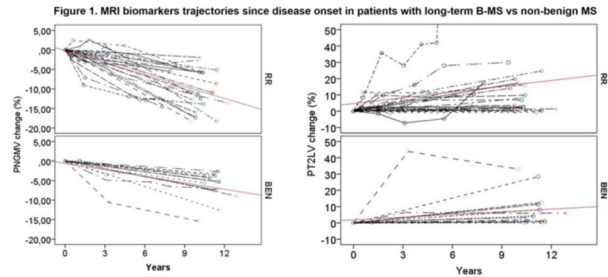

Figure 1

Conclusion: Our findings suggest that global and GM atrophy are less pronounced in MS patients who were not yet disabled after more than 30 years of disease. Changes in GM volume show to be crucial in distinguishing subjects who are less prone to disability accumulation and may be important in characterizing MS patients with benign evolution.

Disclosure: Nothing to disclose

Table 1

Annualized rate of change mean (SE)	B-MS	MS	P value
Brain volumes	0.35 ± 0.04	0.49 ± 0.04	p=0.02
Grey matter volume	0.57 ± 0.08	1.09 ± 0.08	p<0.001
Total T2-lesion volume	0.69 ± 0.29	0.78 ± 0.14	p=0.76

Table 1

EPR3079

Disease modifying therapies discontinuation in relapsing-remitting Multiple Sclerosis: a monocentric cohort study

M. Pasca¹, B. Forci¹, C. Mechi², A. Mariottini¹, A. Barilaro³, L. Massacesi⁴, A.M. Repice²
¹Neurosciences Drugs and Child Health, University of Florence, Florence, Italy, ²Neurology ², Careggi University Hospital-University of Florence, Florence, Italy, ³Department of Neuroscience, Careggi Hospital, Florence, Italy, ⁴University of Florence, Florence, Italy

Background and aims: Discontinuation of a Disease Modifying treatment (DMT) not followed by switch to other DMTs, is a frequent event in relapsing-remitting multiple sclerosis (RR-MS), but in these cases data on disease reactivation are lacking. To investigate disease course and predictive factors of disease activity occurrence in RR-MS patients after DMT discontinuation.

Methods: RR-MS patients under treatment with a DMT (n=1107), were screened. Those, age 18-65, who discontinued a DMT without switching to a new one were included, excluding who interrupted for SP-MS conversion or for pregnancy. Disease course was evaluated in term of relapse rate and disability worsening. Baseline characteristics potentially associated to disease reactivation after DMTs discontinuation were analysed.

Results: Patients (n=62) were included, age 47.8 (22.1–64.3) years, treatment duration 7.3 (0.3-18.1) years. DMT administered were: azathioprine, beta-interferons, glatiramer-acetate; dimethyl-fumarate. Follow-up duration after discontinuation was 4.4 (0.5-16.6) years. Patients with disease activity after discontinuation were 11/62 (17.7%): 8/62 relapsed, 2/62 developed confirmed disability worsening, 1/62 both. Time to 1st relapse was 1.3 (0.1-5.2) years. Among the baseline demographic, clinical and MRI characteristics, a NEDA-3 (No Evidence of Disease Activity) period length before DMT discontinuation inversely correlated with the frequency of patients with disease activity following discontinuation, with cut-off at >5.5, that was associated to a longer disease-free period after discontinuation (aHR=0.2, p=0.04).

Patient characteristics	Observation period	Post treatment		Post treatment, Follow up vs baseline
	Treatment (n=62)	N=62		
	baseline	baseline	Follow-up	
Women n (%)	42 (67.7)	42 (67.7)		
Previous follow up duration, years	2.7 (0.1-34.3) median (range) mean (ES)	7.3 (0.5-18) 7.7 (0.5)	4.4 (0.5-17) 5.06 (0.5)	
Age, years	38.11 (19.7–57.5) median (range) mean (ES)	47.79 (22.1–64.3) 46.48 (1.3)	53.94 (29.3-77.9) 51 (1.39)	
Number of treated patients (%):				
Azathioprine	36 (58)	36 (58.1)	36 (58.1)	
Beta IFN	15 (24)	15 (24.2)	15 (24.2)	
Glatiramer acetate	6 (9.7)	6 (9.7)	6 (9.7)	
Dimethyl fumarate	1 (1.6)	1 (1.6)	1 (1.6)	
Azathioprine+beta IFN	4 (6.4)	4 (6.4)	4 (6.4)	
EDSS, score	1.5 (0–5.5)	1.5 (0–6.5)	1.5 (0–6.5)	
Patients with a relapse, n (%)	62 (100)	31 (50)	9 (14)	p=0.0002 (McNemar test)
Annualized Relapse Rate*	0.61 (0.0–16.6) median (range) mean (ES)	0.0 (0.0–3.9) 1.5 (0.06)	0.0 (0.0–2.6) 0.09 (0.05)	p=0.005 (Wilcoxon test)
Patients with MRI activity†, n (%)	62 (100)	24 (38.7)	Not detected	
Patients with disability worsening, n (%)	52 (82)	8 (13)	3 (5)	p=0.33 (McNemar test)
Patients with clinical or MRI activity, n (%)	62 (100)	36 (58.1)	Not detected	
Patients with disease activity (relapse or disability worsening), n (%)	62 (100)	31 (50)	11 (17.7)	p=0.0008 (McNemar test)
Annualized disease activity†	0.61 (0.0–16.6) median (range) mean (ES)	0.0 (0.0–3.9) 1.5 (0.06)	0.0 (0.0–2.6) 0.11 (0.05)	p=0.005 (Wilcoxon test)
Relapse free period duration, years				
Relapsing patients	1.3 (0.08–16.59) median (range) mean (ES)	5.72 (0.1–14.7) 5.84 (0.39)		
MRI activity† free period duration on treatment, years				
Relapsing patients	5.57 (0.1–14.6) median (range) mean (ES)	5.78 (0.4)		
NEDA 3 [‡] period duration on treatment, years				
Relapsing patients	5.33 (0.1–12.8) median (range) mean (ES)	5.21 (0.36)		

Patient demographic, clinical and MRI characteristics at baseline of the observation periods included and at end of the follow-up.

Observation period median year number (range)	Treatment baseline 2.7 (0.06–34.31)	Post treatment				
		Baseline 7.29 (0.3–18.1)		Follow-up 4.43 (0.5–16.62)		
Patient characteristics						
Relapsing (n %)	6 (9.7)	HR: 0.07 (0.24-1.88)	6 (9.7)	HR: 0.97 (0.24-3.88)	6 (9.7)	HR: 0.97 (0.24-3.88)
Non relapsing (n %)	36 (57.9)	p=0.967	36 (57.9)	p=0.967	36 (57.9)	p=0.967
Duration of the observation period, median years (range)						
Relapsing	1.3 (0.08–16.59)	HR: 0.03 (0.75-1.08)	5.30 (0.5–17.6)	HR: 0.96 (0.80-11.2)	4.83 (0.75-11.5)	HR: 0.03 (0.75-1.15)
Non relapsing	3.42 (0.06–34.32)	p=0.307	7.36 (1.54–18.1)	p=0.704	4.28 (0.51–16.62)	p=0.484
Age, median years (range)						
Relapsing patients	26.87 (19.58–44.14)	HR: 0.98 (0.91-1.05)	31.38 (19.07–47.84)	HR: 0.96 (0.89-1.02)	37.27 (27.36–55.6)	HR: 0.95 (0.89-1.02)
Non relapsing	50.53 (15.54–55.97)	p=0.994	38.59 (20.6–57.50)	p=0.176	48.35 (22.15–64.3)	p=0.13
EDSS, median score (range)						
Relapsing patients	1 (0–3)	HR: 0.77 (0.43-1.38)	2 (0–3)	HR: 0.74 (0.39-1.41)	1.0 (0.0–6.5)	HR: 0.48 (0.18-1.27)
Non relapsing	1 (0–5)	p=0.375	1 (0–6)	p=0.360	1.3 (0.0–6.5)	p=0.140
Patients with a relapse, n (%)						
Relapsing patients	9 (100)		5 (55.6)	HR: 0.91 (0.25-4.41)	Not applicable	
Non relapsing	53 (100)		26 (49.1)	p=0.894		
Time period AHR*, median (range)						
Relapsing patients	0.52 (0.00–12.16)	HR: 1.12 (0.98-1.27)	0.08 (0.0–0.36)	HR: 0.73 (0.14-4.72)	0.21 (0.00–2.61)	
Non relapsing	0.64 (0.03–16.59)	p=0.008	0.0 (0.0–3.8)	p=0.744	0.00 (0.00–0.00)	
Patients with MRI activity†, n (%)						
Relapsing patients	9 (100%)		5 (55.6%)	HR: 1.05 (0.28-3.92)	Not detected	
Non relapsing	53 (100%)		22 (41%)	p=0.487	Not detected	
Clinical and radiological activity†, n (%)						
Relapsing patients	9 (100%)		31 (58.5%)	HR: 0.81 (0.22-3.03)	Not detected	
Non relapsing	53 (100%)		5 (5.6%)	p=0.756	Not detected	
Patients with disease activity†, n (%)						
Relapsing patients	9 (100%)		5 (55.6%)	HR: 0.95 (0.26-3.46)	9 (100%)	
Non relapsing	53 (100%)		26 (49.1%)	p=0.94	2 (3.22%)	
Annualized disease activity†, median (range)						
Relapsing patients	0.52 (0.00–12.16)	HR: 1.12 (0.98-1.27)	0.08 (0.0–0.36)	HR: 0.73 (0.14-4.72)	0.21 (0.00–2.61)	
Non relapsing	0.64 (0.03–16.59)	p=0.008	0.0 (0.0–3.8)	p=0.744	0.00 (0.00–0.12)	
Relapse free period before treatment discontinuation, median years (range)						
Relapsing patients	Not applicable		4.25 (0.33–9.22)	HR: 0.73 (0.58-0.92)	Not applicable	
Non relapsing			6.00 (0.09–14.7)	p=0.008		
MRI activity† free period before treatment discontinuation, median years (range)						
Relapsing patients	Not applicable		4.2 (0.3–11.1)	HR: 0.83 (0.67-1.04)	Not applicable	
Non relapsing			5.75 (0.08–14.63)	p=0.097		
NEDA 3[‡] period before treatment discontinuation, median years (range)						
Relapsing patients	Not applicable		4.2 (0.33–9.22)	HR: 0.77 (0.60-0.98)	Not applicable	
Non relapsing			5.6 (0.08–12.76)	p=0.006		

* Annualized relapse rate: relapse number/patient/year. † MRI activity: presence of new T2 lesion or of gadolinium-enhancing lesions. ‡ Clinical and radiological activity: occurrence of relapse or radiological activity. † disease activity: occurrence of relapses or disability progression. ‡ Annualized disease activity: total number of relapses or of disability worsening/patient/years. @NEDA 3: absence of relapse, radiological activity and disability progression.

Patient demographic, clinical and MRI characteristics, at baseline of the observation periods included, stratified according to relapse status at follow up post treatment discontinuation and univariate analysis of their association.

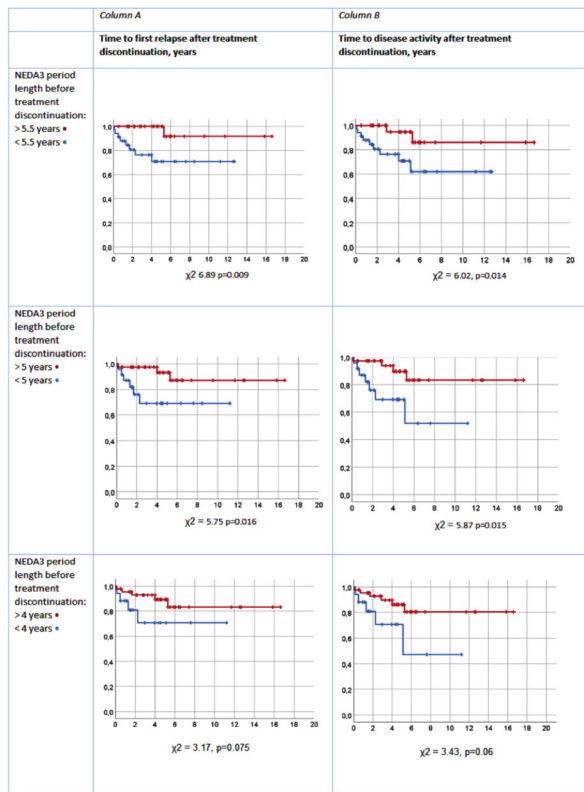

Survival analysis of time to 1st relapse (column A) or time to 1st disease activity (column B) after treatment discontinuation in 2 groups of patients stratified according to different NEDA-3 period length before treatment discontinuation (Kaplan Maier analysis; Breslow's rank-order test).

Conclusion: Discontinuation of a DMT in patients with NEDA-3 period before discontinuation >5.5 years seems safe as associated with very low frequency of disease reactivations.

Disclosure: Professor Luca Massacesi receives fees for participation at advisory board, faculty di teaching course or scientific consultation from: Novartis, Biogen, Roche, Mylan, Genzyme. And educational grant from: Merck-Serono, Teva, Genzyme, Biogen, Novartis, Roche, Mylan.

EPR3080

How Multiple Sclerosis Disease Characteristics Correspond to Cognitive Impairment Status at Baseline: A Post Hoc Analysis of the Ozanimod RADIANCE and SUNBEAM Phase 3 Trials Using PASAT and SDMT Assessments

L.-K. Penner¹, J. Deluca², D. Silva³, D.L. Arnold⁴, J.A. Cohen⁵, B.A.C. Cree⁶, J.K. Sheffield³, H. Liu³, L. Kappos⁷, G. Comi⁸

¹Department of Neurology, Medical Faculty, Heinrich Heine University Düsseldorf, Düsseldorf, Germany, ²Kessler Foundation, West Orange, New Jersey, and Departments of Physical Medicine and Rehabilitation, and Neurology, Rutgers - New Jersey Medical School, Newark, USA, ³Bristol-Myers Squibb, Summit, USA, ⁴NeuroRx Research and Montréal Neurological Institute, McGill University, Montréal, Canada, ⁵Mellen Center for MS Treatment and Research, Cleveland Clinic, Cleveland, USA, ⁶Weill Institute for Neurosciences, Department of Neurology, UCSF University of California San Francisco, San Francisco, USA, ⁷Neurologic Clinic and Policlinic, University Hospital and University of Basel, Basel, Switzerland, ⁸Department of Neurology, San Raffaele Scientific Institute, Vita-Salute San Raffaele University, Milan, Italy

Background and aims: Cognitive impairment occurs early in relapsing multiple sclerosis (RMS) patients, and reliable identification depends on assessment tool(s) used. The Paced Auditory Serial Addition Test (PASAT) assesses several cognitive domains, including processing speed, working memory, calculation ability, divided attention, and mental flexibility. The more sensitive Symbol Digit Modalities Test (SDMT) assesses processing speed and working memory. We compared disease characteristics in RMS participants with/without baseline cognitive impairment assessed by PASAT or SDMT in the phase 3 RADIANCE and SUNBEAM trials of ozanimod, respectively.

Methods: Participants (aged 18–55y) received oral ozanimod HCl 1 or 0.5mg/d or intramuscular interferon beta-1a 30µg/wk in RADIANCE (NCT02047734) and SUNBEAM (NCT02294058). This post hoc analysis compared baseline characteristics between cognitively impaired versus preserved participants within each study. Impairment was defined as baseline PASAT or SDMT score ≥ 1.5 standard deviations below the mean of healthy population norms.

Results: At baseline, most RADIANCE participants were cognitively preserved as assessed by PASAT (preserved 1164/1312 [89%]; impaired 148/1312 [11%]); while SUNBEAM participants were equally distributed regarding their cognitive status assessed by SDMT (preserved 689/1345 [51%]; impaired 656/1345 [49%]). In both trials, cognitively preserved participants were nominally significantly younger, with shorter disease duration, less physical disability and T2 brain lesion burden, and greater QOL and baseline brain volume than impaired participants (Table).

Table. Baseline disease characteristics in phase 3 RADIANCE and SUNBEAM participants by baseline cognitive status (impaired versus preserved)^a

Characteristic, mean (SD)	RADIANCE (PASAT)		SUNBEAM (SDMT)	
	Impaired (n=148)	Preserved (n=1164)	Impaired (n=656)	Preserved (n=689)
Age, years	38.5 (8.33) ^b	35.1 (8.80)	37.9 (9.05)	33.3 (8.93)
No. of relapses in last 12 mo	1.2 (0.52) ^c	1.3 (0.60)	1.3 (0.56)	1.3 (0.57)
No. of relapses in last 24 mo	1.7 (0.86)	1.8 (0.87)	1.7 (0.87)	1.7 (0.83)
Years since diagnosis	4.9 (5.59) ^c	3.5 (4.48)	4.3 (4.55) ^c	3.0 (4.06)
Years since onset	7.7 (6.37) ^c	6.3 (5.85)	8.1 (6.35) ^c	5.9 (5.86)
EDSS score	3.2 (1.19) ^c	2.4 (1.12)	3.0 (1.14) ^c	2.3 (1.01)
MSFC score	-1.1 (0.73) ^c	0.1 (0.60)	-0.4 (0.66) ^c	0.4 (0.46)
PASAT/SDMT score	23.7 (6.42) ^c	50.4 (7.98)	36.2 (6.62) ^c	57.5 (7.98)
Mean 25-foot walk test (sec)	7.9 (4.50) ^c	5.8 (2.74)	6.9 (3.67) ^c	5.6 (2.10)
Mean 9-hole peg test (sec)	27.0 (7.59) ^c	21.5 (5.61)	25.1 (7.66) ^c	20.9 (3.94)
MSQOL-54 score	65.5 (16.92) ^{d,e}	70.0 (15.66) ^e	65.2 (17.52) ^{d,e}	72.3 (15.95) ^e
Mental health composite score	65.6 (18.95) ^d	73.6 (17.49) ^e	65.6 (19.72) ^d	75.8 (17.01) ^e
Physical health composite score	62.4 (18.80) ^{d,e}	70.5 (17.51) ^e	62.9 (18.47) ^{d,e}	74.3 (16.51) ^e
Physical function score	62.7 (27.67) ^d	76.0 (23.56) ^e	65.9 (26.19) ^d	80.0 (22.41) ^e
Cognition function score	69.9 (24.47) ^d	77.6 (21.02) ^e	73.7 (22.07) ^d	80.6 (20.37) ^e
No. of GdE lesions	2.0 (3.77) ^f	1.7 (3.63) ^f	1.9 (3.45) ^{f,g}	1.5 (2.93)
Volume of T2 lesions, cm ³	17.4 (16.97) ^{f,g}	10.7 (12.74) ^f	18.2 (18.46) ^{f,g}	8.1 (9.05)
Whole brain volume, cm ³	1417.0 (82.69) ^f	1452.1 (74.55)	1422.6 (76.33) ^{f,g}	1473.6 (70.93)
Cortical GM volume, cm ³	512.2 (45.50) ^f	531.4 (42.39) ^f	507.8 (47.82) ^{f,g}	539.2 (39.94)
Thalamic volume, cm ³	14.8 (2.18) ^f	15.6 (1.84) ^f	14.5 (2.07) ^f	15.9 (1.64)

^aImpaired was defined as baseline PASAT or SDMT ≥ 1.5 standard deviations below the mean of healthy population norms. ^bnominal P-value <0.0001 for the standard mean difference (preserved - impaired/pooled standard deviation). ^cnominal P-value <0.01 for the standard mean difference (preserved - impaired/pooled standard deviation). ^dnominal P-value <0.05 for the standard mean difference (preserved - impaired/pooled standard deviation). ^en=148, n=1155, ^fn=654, n=686, n=145, n=652, ^gn=885, n=142, n=1131, n=640, n=673, n=1156, n=655, n=147, n=1164, n=1160, n=1181, n=651, n=1162.

BL, baseline; EDSS, Expanded Disability Status Scale; GdE, gadolinium-enhancing; GM, grey matter; MSFC, Multiple Sclerosis Functional Composite; MSQOL-54, 54-item Multiple Sclerosis Quality of Life; PASAT, Paced Auditory Serial Addition Test; SD, standard deviation; SDMT, Symbol Digit Modalities Test.

Table

Conclusion: Our analysis revealed that cognitive impairment at baseline is associated with older age, longer disease duration, and greater disease burden. Although these studies used different cognitive assessments and had dissimilar proportions of cognitively impaired participants, overall findings were consistent across studies.

Disclosure: Study funded by Celgene, a wholly-owned subsidiary of Bristol-Myers Squibb.

EPR3081

Transcriptomic analysis of reactive human iPSC-derived astrocytes induced by neuroinflammatory cytokines

S. Perriot, A. Mathias, M. Canales, R. Du Pasquier
Neurology, CHUV, Lausanne, Switzerland

Background and aims: Astrocytes occupy a central place in neuroinflammatory diseases, such as multiple sclerosis (MS). Recent studies in mice have identified 2 states of astrocyte reactivity, A1 and A2, respectively induced by neuroinflammation and ischemia. However, due to the difficulty in obtaining human astrocytes, validity of these data in a human context remains to be established. Here, we aimed at better characterizing human astrocyte reactivity in different neuroinflammatory conditions. We took advantage of our recently published technique to obtain resting astrocytes from human iPSCs.

Methods: We generated hiPSC-derived astrocytes from healthy donors and MS patients and stimulated them with major neuroinflammatory cytokines (IL-6, IL-1 β and/or TNF α) to assess their transcriptomic profile in response to these stimuli.

Results: Transcriptomic analysis of reactive astrocytes showed 1st that each of these 3 cytokines leads to the modulation of a specific set of genes. 2nd, gene ontology analysis revealed that IL-6 triggered the upregulation of genes mainly involved in cell adhesion, CNS development and ion transport while IL-1 β and TNF α led to the upregulation of genes mainly involved in the inflammatory response, interferon signaling and defense against viruses.

Conclusion: In conclusion, our study reveals specific activation states of astrocytes in response to neuroinflammatory cues, suggesting distinct functionalities in different inflammatory contexts. Our data thus call for a more precise characterization of reactive astrocytes in a given disease to decipher their role in such conditions. Better understanding of these reactive states would lead to a better understanding of astrocyte roles in neuroinflammatory diseases and may allow identifying new therapeutic targets.

Disclosure: Nothing to disclose

EPR3082

Anterior optic pathway pathology in demyelinating CNS diseases

M. Pisa¹, S. Yee², A. Smart², E. Simoes Fernandez², M. Esiri³, L. Leocani⁴, G. Deluca²

¹Neurorehabilitation, Institute of Experimental Neurology, San Raffaele Hospital, Milan, Italy, ²Academic Unit of Neuropathology, Nuffield Department of Clinical Neurosciences, J. Radcliffe Hospital, Oxford, United Kingdom, ³Clinical Neurosciences, Neuropathology, Oxford, United Kingdom, ⁴Neurology, San Raffaele Hospital, Milan, Italy

Background and aims: To characterise pathologic features of pre-geniculate optic pathway involvement in CNS inflammatory demyelinating disorders.

Methods: Post-mortem samples of optic nerves, chiasm, and tracts from 46 cases (MS, n=30; NMOSD, n=6; ADEM, n=5; controls, n=5) were immunolabelled for myelin (PLP), inflammation (CD3, CD20, CD138, C9neo), acute axonal injury (B-APP), astrocytes (GFAP) and AQP-4.

Results: Demyelinated plaques were found in 83% of MS cases, with 76% of cases having active plaques. 43.4% of MS cases had B-APP positivity even in areas without demyelination. An association between plaque activity and B-APP positivity was found ($p < 0.001$). In MS, optic involvement followed an antero-posterior gradient: optic nerves had the largest demyelination area (65.2%; chiasm 45.2%; tract 33.7%; $p = 0.009$), percentage of active plaques (68.2%, 53.8%, 33.3%; $p = 0.053$), and axonal injury (38.2%, 31.6%, 9.5%; $p = 0.027$). In NMOSD, 2 cases with a history of optic neuritis had extensive demyelination, with the remaining cases - without optic neuritis history or demyelination - showed intense infiltration of CD3+ and CD68+ cells in the normal appearing white matter (NAWM) as seen in MS; the 33.3% of samples presented acute axonal injury. Meningeal inflammation was more frequent in NMOSD vs MS and ADEM, both considering CD3+/CD68+ cells (100%, 60%, 60.7%, $p = 0.006$) and B-cells (88.9%, 36%, 0%; $p < 0.001$).

Conclusion: Inflammation and axonal injury along the pre-geniculate pathway are frequent in MS and follow an antero-posterior gradient. Meningeal and NAWM involvement – generally considered typical of MS pathology – are also common in NMOSD without prior optic neuritis.

Disclosure: Nothing to disclose

EPR3083

Effects of Fingolimod and Natalizumab on Slowly Expanding Lesion Occurrence Over Two Years of Treatment in Relapsing-Remitting Multiple Sclerosis

P. Preziosa¹, E. Pagani², L. Moinola³, M. Rodegher³, M. Filippi⁴, M.A. Rocca¹

¹Neuroimaging Research Unit, Institute of Experimental Neurology, Division of Neuroscience; and Neurology Unit, IRCCS San Raffaele Scientific Institute, Milan, Italy, ²Neuroimaging Research Unit, Institute of Experimental Neurology, Division of Neuroscience, IRCCS San Raffaele Scientific Institute, Milan, Italy, ³Neurology Unit, IRCCS San Raffaele Scientific Institute, Milan, Italy, ⁴,

Background and aims: Fingolimod and natalizumab are highly effective treatments for relapsing-remitting multiple sclerosis (RRMS). We compared their effects on white matter lesions showing a 2-year progressive linear enlargement, a putative biomarker of smoldering inflammation.

Methods: RRMS patients starting fingolimod (n=25) or natalizumab (n=30) underwent 3T brain MRI scans at baseline, month 6, 12 and 24. We identified slowly expanding lesions (SELs) among baseline lesions, by linearly fitting the Jacobian of the non-linear deformation field between timepoints, obtained using T1- and T2-weighted scans. A threshold of annual increase $\geq 12.5\%$ was applied and neighbour voxels were grouped in clusters (≥ 10 voxels). Number, percentage, volume of lesions defined as SELs, and their average magnetization transfer ratio (MTR) and T1 intensity were calculated.

Results: Treatment-groups were matched for baseline variables. The proportion of patients showing ≥ 1 SEL was similar between the 2 treatments (fingolimod=76%; natalizumab=60%, $p = 0.21$). In the 2 groups, similar number (median [interquartile range]) (fingolimod=2 [0-6]; natalizumab=1 [0-5], $p = 0.27$) and volume (fingolimod=7.3 [3.2-14.6]; natalizumab=5.7 [2.7-15.1] ml, $p = 0.31$) of SELs, and percentages of lesions (fingolimod=4.2% [0.3-7.5]; natalizumab=1.8% [0.0-10.6], $p = 0.80$) and of lesional volume (fingolimod=0.4% [0.0-2.9]; natalizumab=0.1% [0.0-1.7], $p = 0.28$) defined as SELs were found. In both groups, compared to not-SELs, SELs showed significantly lower baseline MTR and T1 intensity ($p \leq 0.005$), without significant between-group differences and longitudinal changes.

Conclusion: T1-, T2-weighted and MTR sequences could identify chronic active lesions characterized by smoldering inflammation, ongoing demyelination and axonal loss. Natalizumab and fingolimod similarly influence SEL burden and prevent microstructural tissue damage accumulation both in SELs and not-SELs.

Disclosure: Nothing to disclose

EPR3084

Long-term Disease Stability Assessed by the Expanded Disability Status Scale in Patients Treated with Cladribine Tablets in the CLARITY and CLARITY Extension Studies

G. Giovannoni¹, G. Comi², K. Rammohan³, P. Rieckmann⁴, P. Vermersch⁵, F. Dangond⁶, B. Keller⁷, D. Jack⁷

¹Queen Mary University of London, Blizard Institute, Barts and The London School of Medicine and Dentistry, London, United Kingdom, ²Department of Neurology and Institute of Experimental Neurology, Università Vita-Salute San Raffaele, Ospedale San Raffaele, Milan, Italy, ³University of Miami School of Medicine, MS Research Center, Miami, USA, ⁴Center for Clinical Neuroplasticity, Medical Park Loipl and University of Erlangen, Erlangen, Germany, ⁵Univ. Lille, INSERM U1172, CHU Lille, FHU Imminent, Lille, France, ⁶EMD Serono Research & Development Institute Inc., Billerica, USA, ⁷Merck KGaA, Darmstadt, Germany

Background and aims: Treatment with cladribine tablets 10mg (cumulative dose 3.5mg/kg [CT3.5] over 2 years) in CLARITY and CLARITY Extension reduced relapse rate and slowed disability progression versus placebo in patients with relapsing remitting multiple sclerosis (RRMS). This study aimed to evaluate long-term disease stability assessed by the Expanded Disability Status Scale (EDSS) in RRMS patients after treatment with CT3.5 in CLARITY and CLARITY Extension.

Methods: Patients randomised to CT3.5 in CLARITY, then placebo in CLARITY Extension (CP3.5, n=98), with ≥1 post-baseline EDSS measurement were included. EDSS score over time (CLARITY randomisation to end of follow-up in CLARITY Extension, including bridging interval between studies) was assessed at 6-monthly intervals, separate 3- and 6-month time intervals confirmed EDSS score progression from CLARITY baseline. EDSS score worsening/improvement in each year defined as any increase/decrease in minimum EDSS score at 6-monthly intervals; all other cases classed as stable.

Results: 5 years after CLARITY baseline, median CP3.5 EDSS score remained stable with values between 2.0–3.0 and median change of 0. At 5 years, median CP3.5 EDSS score (95% confidence interval) was 2.5 (2.0–3.5), versus 3.0 (2.5–3.5) at baseline (Figure 1). In each 12-month period, EDSS score stability was observed in >50% patients, and was observed in 53.9% of patients during Year 5 (Figure 2). Less than 30% of patients reached 3- or 6-month confirmed EDSS progression by Year 5.

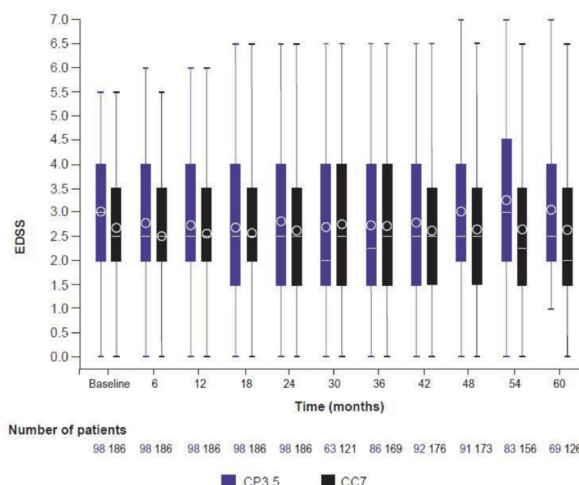

Figure 1: EDSS Score Over Time in Patients Treated with CP3.5 and CC7 (Line = Median. Circles = Mean. Box = Q1, Q3. Error bars reflect the minimum and maximum EDSS score. CC7, CT3.5 CLARITY, CT3.5 CLARITY Extension; CP3.5, CT3.5 CLARITY, placebo Extension; EDSS, Expanded Disability Status Scale)



Worsened: any increase in EDSS score ≥ 1 (baseline EDSS 0.5–4.5) OR ≥ 1.5 (EDSS 0) OR ≥ 0.5 (EDSS ≥ 5.0).

Improved: any decrease in EDSS score ≥ 1 (baseline EDSS 1–4.5) OR ≥ 0.5 (EDSS ≥ 5.0).

Stable: all remaining cases i.e. increase or decrease < 1.0 (baseline EDSS 0.5–4.5) OR < 1.5 (EDSS 0) OR no change (EDSS ≥ 5.0).

Figure 2: Change in EDSS Score in Each 12 Month Period Up to 5 Years in the CP3.5 and CC7 Patient Groups (CC7, CT3.5 CLARITY, CT3.5 CLARITY Extension; CP3.5, CT3.5 CLARITY, placebo Extension; EDSS, Expanded Disability Status Scale.)

Conclusion: EDSS score was stable up to 5 years post-CLARITY baseline for the CP3.5 group. Between 20-30% of patients demonstrated improvement in EDSS score versus baseline each year.

Disclosure: This study was sponsored by EMD Serono Inc., a business of Merck KGaA, Darmstadt, Germany (in the USA), and Merck Serono SA, Geneva, an affiliate of Merck KGaA Darmstadt, Germany (ROW).

MS and related disorders 8

EPR3085

Efficacy and safety of alemtuzumab in RRMS patients in a real-world experience of a specialized MS centre

F. Rodríguez Jorge¹, S. Sainz de la Maza¹, A. Gómez López¹, Á. Beltrán Corbellini¹, J.L. Chico García², P. Parra Díaz¹, A. Sánchez Sánchez¹, B. Baena Álvarez², R. Sainz Amo¹, L.M. Villar Guimerans³, J. Masjuan Vallejo¹, L. Costa-Frossard França¹, E. Monreal Laguillo¹

¹Neurology, Hospital Ramón y Cajal, Madrid, Spain,

²Neurology, Hospital Universitario Ramón y Cajal, Madrid, Spain,

³Immunology, Hospital Ramón y Cajal, Madrid, Spain

Background and aims: Alemtuzumab is a very high effective treatment for relapsing-remitting multiple sclerosis (RRMS), though a wide range of side effects might be expected. Our aim is to describe its efficacy and safety in a real-world context.

Methods: Prospective collection of clinical, radiological and safety variables in RRMS patients treated with Alemtuzumab from April 2015 to January 2020 in a specialized MS centre.

Results: 50 patients received a 1st infusion and were included. 46 patients had at least 1 year of follow-up and 27 at least 2 years. At baseline, they were mainly young (mean age at first infusion of 34.4 years, SD \pm 8.80) and active (median ARR of 0.86, IQR 0.64-1.76). ARR was decreased by 94.1% ($p < 0.0001$) and 94.8% ($p < 0.0001$) and EDSS remained stable or improved in 95.6% and 89.3% after 1 and 2 years, respectively. After 2 years ($n = 25$), 68% of patients were free of radiological activity. NEDA3 was achieved in 60.9% and 58.3% of patients after 1 and 2 years and 83.3% between years 1 and 2 (mainly due to radiological activity). Treatment-naïve patients with 2 years of follow-up ($n = 12$) remained 100% free of relapses and disability progression after 2 years. Infusion-related reactions and mild-moderate infections were highly incident. Dysthyroidism occurred in 22.0% of patients.

Conclusion: In line with the pivotal trials, Alemtuzumab shows an early high effect, which could be higher in treatment-naïve patients. Similar infusion-related and autoimmunity side effects were observed, but with a higher rate of mild-moderate infections.

Disclosure: Nothing to disclose

EPR3086

The influence of glatiramer acetate on dendritic cells mediated Th17-immune response in multiple sclerosis.

S. Sharanova¹, M. Melnikov¹, V. Rogovskii², A. Sviridova³, A. Boyko³, M. Pashenkov⁴

¹Department of Neurology, Neurosurgery and Medical Genetics, Pirogov Russian National Research Medical University, Moscow, Russian Federation, ²Department of Molecular Pharmacology and Radiobiology, Pirogov Russian National Research Medical University, Moscow, Russian Federation, ³Department of Neuroimmunology, Federal Center of Cerebrovascular pathology and Stroke, Moscow, Russian Federation, ⁴Laboratory of Clinical Immunology, Institute of Immunology, Moscow, Russian Federation

Background and aims: Glatiramer acetate (GA) can influence on multiple sclerosis (MS) pathogenesis by modulating T-cell function. The effect of GA on Th17-cells which play crucial pathogenic role in MS is not sufficiently investigated. The aim of this study was to clarify the effects of GA on Th17-immune response in MS.

Methods: 25 MS patients and 25 healthy controls were examined. Peripheral blood mononuclear cells (PBMCs) and CD4⁺-T-cells were stimulated with anti-CD3/anti-CD28-antibodies in the absence/presence of GA at concentrations of 50 μ g/ml and 100 μ g/ml whereafter levels of IL-17, IFN-gamma and IL-10 in supernatants were determined by ELISA. Immature DCs were stimulated with lipopolysaccharide in the absence/presence of GA (50 μ g/ml and 100 μ g/ml) whereafter levels of IL-6 and IL-1 beta were determined. CD4⁺-T-cells were also stimulated with GA pretreated DCs whereafter IL-17 and IFN-gamma were assessed.

Results: GA reduced IL-17 production by stimulated PBMCs and CD4⁺-T-cells in both concentrations in all groups ($p < 0.001$) and IFN-gamma production in MS patients ($p < 0.001$). There was no effect of GA at concentration of 50 μ g/ml on IL-10 production in both groups, while at concentration of 100 μ g/ml GA suppressed IL-10 production in healthy subjects ($p < 0.001$). At concentration of 100 μ g/ml GA suppressed IL-1 beta production by DCs in both groups ($p < 0.01$) and IL-6 production in healthy subjects ($p < 0.01$). The treatment of DCs with GA at concentration of 100 μ g/ml suppressed cytokines production by CD4⁺-T-cells in both groups ($p < 0.05$).

Conclusion: These data suggest an inhibitory effect of GA on Th17-immune response in MS.

Disclosure: This research was supported by grant from JSC Biocad, the funders had no role in study design, data collection and analysis, decision to publish, or preparation of the abstract.

EPR3087

Recurrent optic neuritis: 20 years experience in a multiple sclerosis unit.

V. Ros-Castelló¹, A. Gómez-López¹, E. Natera-Villalba¹, A. Sánchez-Sánchez¹, S. Sainz de la Maza¹, L. Costa-Frossard França¹, L.M. Villar², E. Monreal¹, J. Masjuan¹

¹Neurology, Hospital Ramón y Cajal, Madrid, Spain, ²Servicio de Inmunología. Hospital Universitario Ramón y Cajal. IRYCIS. Madrid. Spain

Background and aims: Recurrent optic neuritis (ON) can be the first manifestation of multiple sclerosis (MS), neuromyelitis optica spectrum disorder (NMOSD), chronic relapsing inflammatory optic neuropathy (CRION) or relapsing inflammatory optic neuropathy (RION) among others. Clinical presentation, immunology tests and neuroimaging may help in the differential diagnosis.

Methods: Patients with ≥ 2 ON were retrospectively collected from 1998 to 2018. Clinical, radiological, laboratory, therapeutic and prognostic variables were assessed.

Results: 19 patients with 46 episodes of ON were included, 15/19 (79%) females, with a mean (SD) age at onset of 31 ± 12 years and a median follow-up of 5.5 years (IQR 4-14). 8 patients met criteria of MS, 6 of CRION, 2 of NMOSD, 2 of RION and 1 systemic lupus erythematosus. 2 patients had simultaneous bilateral ON at onset (1 CRION and one NMOSD). Oligoclonal bands were only positive in 5/7 (71%) of MS patients and anti-AQP4 antibodies were positive in 1/2 NMOSD patients. None of the patients had positive anti-MOG antibodies. A normal final visual function was more frequently observed in MS (50%) and CRION (33%) than in NMOSD or RION patients (0%). Immunosuppressor treatment was frequently started in NMOSD (100%), CRION (83%) and MS (62.5%) but not in RION (0%) after a median of 47 months (IQR 11-93), being rituximab (46%) and azathioprine (31%) the most frequently chosen, with only one recurrent ON (NMOSD).

Conclusion: In our experience recurrent ON is a disabling entity with a wide range of possible etiologies. Consequently, the final diagnosis and the start of a specific immunosuppressor treatment may be delayed.

Disclosure: Nothing to disclose

EPR3088

Description of clinical and therapeutic characteristics of Multiple Sclerosis (MS) in elderly patients in our population

L. Ruiz-Escribano Menchén, A. Hernández González, A. Franco Salinas, F.J. Villanueva Ruiz, L. Quirós Illán, M.J. Corrales Arroyo, M.A. Gudín Rodríguez-Magariños, M.A. Del Real Francia

Neurology, General University Hospital of Ciudad Real, Ciudad real, Spain

Background and aims: Improvement of global healthcare and life expectancy increase has led to an enhanced number of elderly patients with MS. This raises a lot of questions about the course and therapy in this specific population. We describe the characteristics of MS patients ≥ 55 years old in our population.

Methods: Of a total population (TP) of 248 patients from our database we selected 65 with age ≥ 55 years and studied their characteristics. The average age in this group was 61 (rank 55-76) being 62% women and 32.3% men.

Results: The average age of diagnosis was 44 years (34 in TP). The average time of diagnostic delay was 2.55 years (1.74 in TP), of delay of treatment beginning was 6.10 years (3.65 in TP), and of delay between the diagnosis and the beginning of treatment was 3.5 years (1.95 in the TP). In the group ≥ 55 years, 78.5% were RRMS form (90% in TP), 1.5% PPMS (1.6% in TP) and 20% SPMS (8.5% in TP). Average EDSS in ≥ 55 years patients was 3.77 (2.9 in TP), and 46.15% of this subgroup had a score < 4 (67.7% in TP). Regarding the treatment, 56% received injectable drugs: interferon or glatiramer.

Conclusion: In our MS population, 26.6% are older patients. They have increased disability and more frequent secondary progressive course than our TP. Injectable drugs are the most disease-modifying drugs used. We remark that it's necessary enhance the knowledge about the pathophysiology, the influence of comorbidities, and evolution of MS in aged patients, to optimize the risk/balance of therapies.

Disclosure: Nothing to disclose

EPR3089

Relationships between selected parameters of spectral optical coherence tomography and visual evoked potentials in the natural history of multiple sclerosis.

J. Kucharczuk¹, Ł. Rzepiński²

¹Department of Ophthalmology, The 10th Military Research Hospital and Polyclinic, Bydgoszcz, Poland, ²Department of Neurology, 10th Military Research Hospital and Polyclinic, Bydgoszcz, Poland

Background and aims: Spectral optical coherence tomography (SOCT) and pattern-reversal visual evoked potentials (pVEPs) remain valuable markers of the visual pathway damage in multiple sclerosis (MS). The aim of the study was to assess relationships between selected SOCT and pVEPs parameters in treatment-naïve patients with clinically isolated syndrome (CIS) and various MS types.

Methods: We enrolled 15 CIS patients and 111 MS patients (Table 1). The history of optic neuritis (ON) was confirmed in the case of: 3 eyes from the CIS patients, 35 eyes from the relapsing-remitting MS patients, 12 eyes from the secondary progressive MS patients, 1 eye from the primary progressive patients and 14 eyes from the benign MS patients. All participants underwent SOCT (Copernicus HR-SOCT) with peripapillary retinal nerve fiber layer (pRNFL) thickness and total macular volume (TMV) evaluation as well as pVEPs with P100 wave latency assessment.

Investigated subgroups	No. of patients	The median disease duration (years)	The median EDSS score (points)
CIS	15	1	0
Relapsing-remitting MS (RRMS)	65	3	2.0
Secondary progressive MS (SPMS)	14	9.5	4.3
Primary progressive MS (PPMS)	11	4	5.0
Benign MS (BNMS)	21	16	2.0

Table 1. The clinical characteristics of the investigated patients.

Results: A significant correlation was found between the mean TMV and P100 latency in the eyes of patients with CIS and all assessed MS variants (Figure 1). A significant correlation was found between the the mean pRNFL thickness and P100 latency in the eyes of MS patients. There was no significant correlation between the mean pRNFL thickness and P100 latency in the eyes of CIS

patients (Figure 2).

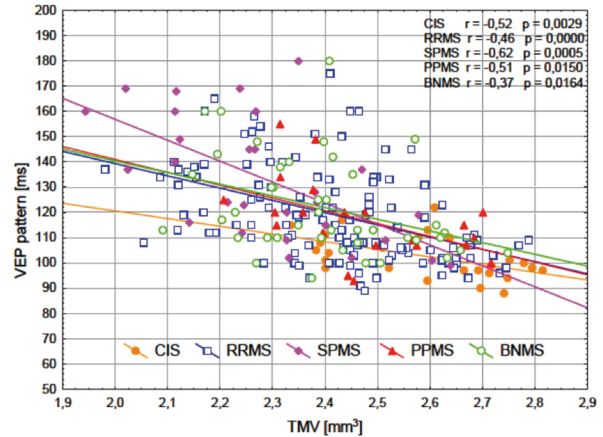

Figure 1. Relationship between TMV and latency of P100 pVEPs in patients with various clinical forms of MS and CIS.

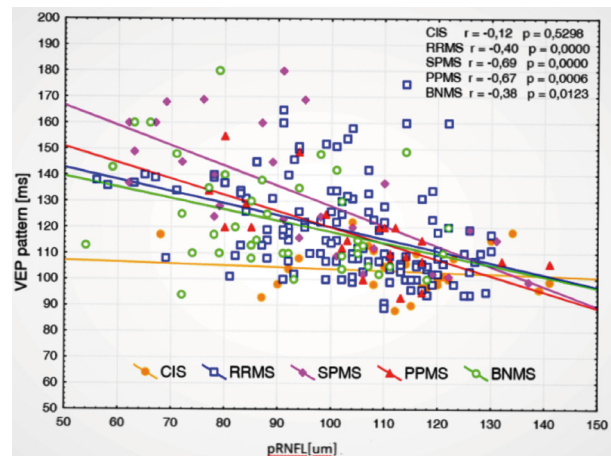

Figure 2. Relationship between pRNFL thickness and latency of P100 pVEPs in patients with various clinical forms of MS and CIS.

Conclusion: In the natural history of multiple sclerosis, the strongest correlation between the analyzed SOCT parameters (pRNFL, TMV) and pVEPs P100 wave latency was found in SPMS patients. In the case of CIS patients, only the mean TMV was significantly correlated with P100 latency.

Disclosure: Nothing to disclose

EPR3090

Long-term natalizumab treatment is related to reduced deep-brain atrophy and increased choline and glutamate levels in relapsing-remitting multiple sclerosis

T.A. Broeders¹, M.D. Steenwijk¹, K.A. Meijer¹, P. Pouwels², A.J. Eijlers¹, M. Huiskamp¹, J. Killestein³, J.J. Geurts¹, M.M. Schoonheim¹

¹Department of Anatomy and Neurosciences, Amsterdam Neuroscience, Amsterdam UMC, Vrije Universiteit Amsterdam, Amsterdam, Netherlands, ²Radiology and Nuclear Medicine, Amsterdam UMC, Vrije Universiteit Amsterdam, Amsterdam, Netherlands, ³Department of Neurology, Amsterdam UMC, Vrije Universiteit Amsterdam, Amsterdam, Netherlands

Background and aims: Natalizumab (NA) is an effective treatment for relapsing-remitting multiple sclerosis (RRMS). This study evaluated the long-term effects of NA treatment on grey-matter (GM) atrophy, as well as metabolite concentrations in GM, normal-appearing white matter (NAWM), and lesional WM (LWM) in RRMS.

Methods: Patients who switched to NA 4 years prior were matched to patients continuing 1st-line treatment (IFN/GA) and healthy controls (HCs). At baseline (Y4) and after 2 years (Y6) GM volumes and metabolite concentration ratios to total creatine (N-acetylaspartate, choline, myo-inositol, and glutamate and glutamine) were measured for NA (n=18/11; Y4/Y6), IFN/GA (n=20/14) and HCs (n=19/16). Changes over time and between groups were assessed with Bonferroni-corrected linear mixed models.

Results: Over time, IFN/GA patients showed a significant reduction in deep GM volume (p<0.001) and particularly thalamic volume (p<0.001), which were not seen in NA patients. In addition, over time, only NA patients showed an increase of glutamate levels in NAWM (p<0.001), and choline in GM (p=0.004). No significant differences between patient groups were found at Y4, and patients did not show changes in cognitive and neurological performance over time.

Table 1. Demographics and clinical measurements at baseline in controls, first-line and natalizumab treated patients

	HC	IFN/GA patients	NA patients	Pairwise comparisons	
				HC vs MS	IFN/GA vs NA
Age	38.26 (±8.5)	41.50 (±7.0)	37.50 (±8.7)	F=1.3 p=0.270	F=2.5 P=0.126
Gender (F/M)	11/8	10/10	14/4	χ ² =1.6 p=0.446	χ ² =6.2 p=0.045*
Education *	7 (6-7)	6 (4-6)	6 (4-7)	χ ² =14.3 p=0.014*	χ ² =2.6 p=0.635
Handedness (L/R)	4/15	2/18	1/17	χ ² =3.6 p=0.169	χ ² =3.3 p=0.188
Avg. cognition	-0.01(±0.6)	-0.97(±0.8)	-0.71(±0.8)	F=17.299 p<0.001*	F=1.0 P=0.328
EDSS *		2.50 (1.6-3.0)	3.00 (2.4-6.0)		F=2.8 p=0.104

All values per group represent means and standard deviations for continuous variables, the values represent medians and interquartile distance (*) or frequencies for categorical variables. HC=healthy control, NA=natalizumab, IFN/GA=interferon or glatiramer acetate treatment, F is female, M is male, L is left, R is right, EDSS=expanded disability status scale. Education represents the highest level of education attained in the Dutch system (1-7), average cognition represents the average z-score (compared to controls) of the entire expanded Brief Repeatable Battery of Neuropsychological tests (BRB-N).

Demographics and clinical measurements at baseline in controls, 1st-line and natalizumab treated patients

Table 2. MRI measures of atrophy and metabolites in both patient groups over time

	Baseline	Follow-up	F-statistic	p-value
<i>NA patients</i>				
NDGMV	-2.36 (±1.28)	-2.47 (±1.82)	0.0	0.978
NTV	-2.57 (±1.39)	-3.01 (±2.06)	0.6	0.459
GM Glu	-1.59 (±1.07)	0.08 (±1.38)	22.1	0.004*
NAWM Cho	-0.62 (±1.08)	1.12 (±1.60)	42.0	<0.001*
<i>IFN/GA patients</i>				
NDGMV	-2.47 (±1.99)	-3.08 (±2.03)	25.4	<0.001*
NTV	-2.74 (±1.98)	-3.45 (±2.09)	30.4	<0.001*
GM Glu	0.11 (±1.81)	0.51 (±0.89)	0.6	0.445
NAWM Cho	-0.08 (±1.52)	-0.82 (±2.48)	0.9	0.350

All values represent mean z-scores (compared to controls within the time point) and standard deviations; F- and p-values are based on linear mixed models. NA=natalizumab, IFN/GA=interferon or glatiramer acetate treatment, NDGMV=normalized deep grey matter volume, NTV=normalized thalamus volume, GM=grey matter, Glu=glutamate, NAWM=normal-appearing white matter, Cho=choline.

MRI measures of atrophy and metabolites in both patient groups over time

Conclusion: In this study, long-term NA treatment was related to a preservation of deep grey matter volumes and increases in glutamate and choline levels, thought to reflect increased metabolism and membrane turnover. IFN/GA patients, however, showed significant deep-brain atrophy and no metabolite change. These findings could indicate a more neuroprotective profile for NA compared to IFN/GA in RRMS.

Disclosure: This study was funded by a research grant from Biogen.

EPR3091

Long-term Efficacy of Ozanimod in Relapsing Multiple Sclerosis in DAYBREAK: An Open-Label Extension of the Phase 3 SUNBEAM and RADIANCE Trials

K.W. Selmaj¹, L. Steinman², G. Comi³, A. Bar-or⁴, D.L. Arnold⁵, H.-P. Hartung⁶, X. Montalban⁷, E.K. Havrdova⁸, J.K. Sheffield⁹, J. Hetzer⁹, D. Silva⁹, L. Kappos¹⁰, J.A. Cohen¹¹, B.A.C. Cree¹²

¹Center for Neurology, Łódź, Poland and Collegium Medicum, Department of Neurology, University of Warmia and Mazury, Olsztyn, Poland, ²Department of Neurology and Neurological Sciences, Beckman Center for Molecular Medicine, Stanford University Medical Center, Stanford, USA, ³Department of Neurology, San Raffaele Scientific Institute, Vita-Salute San Raffaele University, Milan, Italy, ⁴Center for Neuroinflammation and Experimental Therapeutics, and Multiple Sclerosis Division, Perelman School of Medicine, University of Pennsylvania, Philadelphia, USA, ⁵NeuroRx Research and Montréal Neurological Institute, McGill University, Montréal, Canada, ⁶Department of Neurology, Medical Faculty, Heinrich-Heine University, Düsseldorf, Germany, ⁷Division of Neurology, St. Michael's Hospital, University of Toronto, Toronto, Canada; Department of Neurology-Neuroimmunology, Centre d'Esclerosi Múltiple de Catalunya (Cemcat), Hospital Universitari Vall d'Hebron, Barcelona, Spain, ⁸Department of Neurology and Center for Clinical Neuroscience, First Medical Faculty, Charles University, Prague, Czech Republic, ⁹Bristol-Myers Squibb, Summit, USA, ¹⁰Neurologic Clinic and Polyclinic, University Hospital and University of Basel, Basel, Switzerland, ¹¹Mellen Center for MS Treatment and Research, Cleveland Clinic, Cleveland, USA, ¹²Weill Institute for Neurosciences, Department of Neurology, UCSF University of California San Francisco, San Francisco, USA

Background and aims: Ozanimod, a sphingosine 1-phosphate receptor 1/5 modulator, significantly reduced annualised relapse rate (ARR) in phase 3 relapsing multiple sclerosis (RMS) trials. We evaluated long-term efficacy of ozanimod in RMS in an open-label extension (OLE) trial. **Methods:** RMS participants who completed a phase 3 double-blind ozanimod trial (SUNBEAM [≥ 12 months], RADIANCE [24 months]) were eligible to enrol in an OLE (DAYBREAK) of ozanimod HCl 1mg/day. In this OLE interim analysis (data cutoff 31/1/2019), ARR, time to 1st relapse, number of new/enlarging T2 and gadolinium-enhancing (GdE) MRI brain lesions, and 3- and 6-month confirmed disability progression (CDP) were analysed descriptively by randomisation to intramuscular interferon β -1a 30 μ g/wk or oral ozanimod HCl 0.5 or 1mg/d in the double-blind trials.

Results: Of 2,666 participants enrolled, 2,394 completed the phase 3 parent trials and 2,257 entered DAYBREAK (interferon: n=741; ozanimod 0.5mg:n=756; ozanimod 1mg:n=760). In DAYBREAK, ARR and numbers of new/enlarging T2 and GdE lesions remained low in the continuous ozanimod 1mg group and were reduced versus

parent trials in those who switched to ozanimod 1mg in DAYBREAK from ozanimod 0.5mg or interferon in the parent trials (Figures 1–3). Median time to 1st relapse in the continuous ozanimod 1mg group was 1,750 days. CDP rates were low and comparable between parent-treatment groups.

Figure 1. Annualised Relapse Rate During Phase 3 Parent and OLE (DAYBREAK) Trials.

Negative binomial regression was used to calculate the annualised relapse rate in the phase 3 (parent) and OLE trials, with adjustments for parent-treatment group, region (Eastern Europe vs rest of world), age at parent baseline and parent-baseline number of gadolinium-enhancing lesions, with time on treatment as an offset term. The phase 3 (parent) treatment period includes parent trial day 1 through the end of treatment during the parent trial; the OLE treatment period is from OLE trial day 1 through the last dose date or the data-cutoff date, whichever occurs first.

CI, confidence interval; IFN, interferon; OLE, open-label extension.

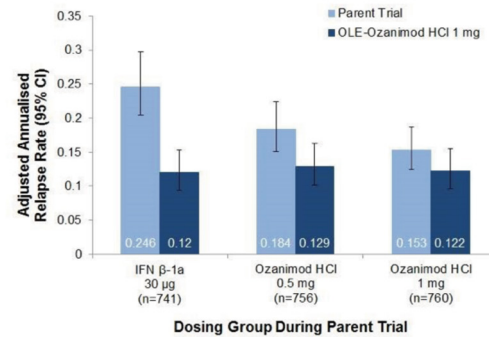

Figure 1

Figure 2. Number of New/Enlarging T2 Lesions Per MRI Scan at Month 12 in the Phase 3 Parent Trials and Months 12 and 24 in the OLE Trial (DAYBREAK).

^aFor the parent trial data, baseline refers to parent trial baseline, and for the OLE trial data, baseline refers to the OLE baseline.

IFN, interferon; MRI, magnetic resonance imaging; OLE, open-label extension; SE, standard error.

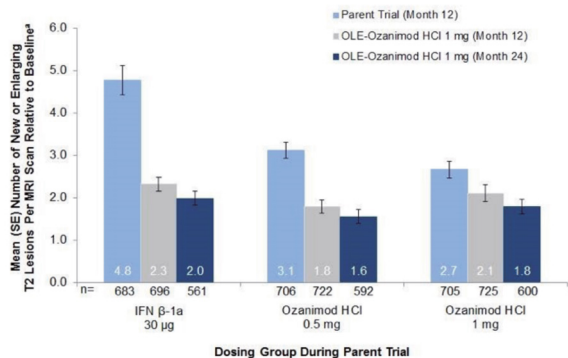

Figure 2

Figure 3. Number of GdE Lesions at Month 12 in the Phase 3 Parent Trials and Months 12 and 24 in the OLE Trial (DAYBREAK).

GdE, gadolinium-enhancing; IFN, interferon; OLE, open-label extension; SE, standard error.

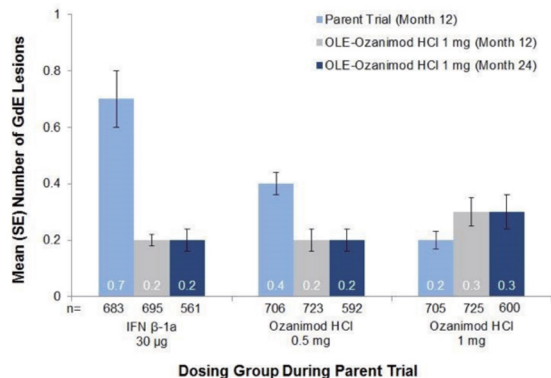

Figure 3

Conclusion: Participants on continuous ozanimod 1mg had sustained low ARR and lesion counts. ARR and lesion counts decreased among those who switched from ozanimod 0.5mg and interferon to ozanimod 1mg in DAYBREAK.

Disclosure: Study funded by Celgene, a wholly-owned subsidiary of Bristol-Myers Squibb.

EPR3092

Assessing the Duration of EDSS improvement After a Therapy Start: A New Statistical Approach Applied to the Long Term Extension of the PRISMS Study

A. Signori¹, F. Bovis¹, L. Carmisciano¹, N. Alexandri², M.P. Sormani³

¹Department of Health Sciences, Department of Health Sciences, Section of Biostatistics, University of Genoa, Genoa, Genoa, Italy; ²Merck KGaA, Darmstadt, Germany; ³Department of Health Sciences, University of Genoa and Ospedale Policlinico San Martino IRCCS, Genoa, Italy

Background and aims: Incidence of expanded disability status scale (EDSS) improvement in multiple sclerosis (MS) has previously been studied as the incidence of progression, using Kaplan-Meier (KM) curves. However, in a chronic, progressive disease, improvement can be transient. Estimating prevalence of disability improvement over time, accounting also for improvement duration, is of interest.

Methods: In PRISMS-2, patients with relapsing-remitting MS were randomised to subcutaneous interferon-beta-1a (scIFN beta-1a) 22 μ g, 44 μ g, or placebo for 2 years. Only placebo and scIFN beta-1a 44 μ g groups were included in this analysis. At Year-2, placebo patients were re-randomised to scIFN beta-1a 22 μ g or 44 μ g (delayed scIFN beta-1a); scIFN beta-1a 22 μ g or 44 μ g patients continued their initial regimen (early scIFN beta-1a). Disability improvement defined as a 1-point decrease in EDSS from baseline confirmed at 6 months; improvement lost when EDSS score \geq baseline. Prevalence of patients with improved EDSS estimated as the difference between the KM estimators for the probability to experience improvement before time, and probability of returning to baseline before time.

Results: No significant difference in incidence of EDSS improvement estimated by KM curves between delayed and early scIFN beta-1a 44 μ g (Figure 1). Taking duration of improvement into account, the proportion of patients who showed an improved condition after 5 years was significantly different between delayed scIFN beta-1a and early scIFN beta-1a 44 μ g (Figure 2).

EPR3093 CSF Neurofilament Light Chain for guiding individual treatment decisions in multiple sclerosis

I. Smets¹, S. Reyes¹, K. Carrillo-Loza², M. Mateo-Casas², L. Bianchi², D. Holden², F. Ammoscato², B. Turner¹, K. Schmierer¹, M. Marta¹, G. Giovannoni¹, S. Gnanapavan¹

¹Neurology, Barts Health NHS Trust, London, United Kingdom, ²Neuroscience and Trauma, Blizard Institute, London, United Kingdom

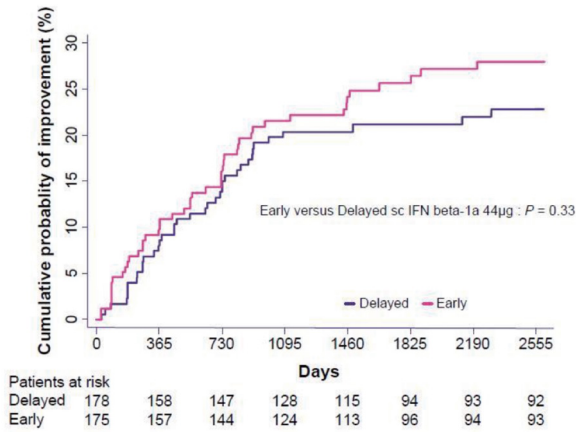

Figure 1: Cumulative Probability of Improvement in Early and Delayed sc IFN beta-1a 44 µg

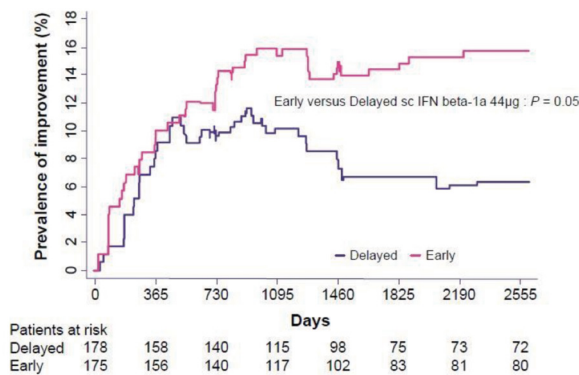

Figure 2: Prevalence of Improvement in Early and Delayed sc IFN beta-1a 44 µg

Conclusion: Early versus delayed scIFN beta-1a 44µg initiation did not significantly affect the number of improvement events from baseline, but did show significant differences in the proportion of patients who maintained disability improvement over 5 years.

Disclosure: The study was sponsored by Merck KGaA, Darmstadt, Germany.

Background and aims: CSF neurofilament light chain (NfL) levels are a biomarker of axonal damage. The goal of this study is to evaluate the effect of CSF NfL levels on disease-modifying drug (DMT) decisions and outcomes among multiple sclerosis (MS) patients.

Methods: We reviewed a study population of MS patients that had a CSF NfL measurement between December 2015 and July 2018 as a part of their routine clinical follow-up at BartsMS, London. We used NfL levels in parallel with clinical and radiological surrogates of disease activity to guide DMT decisions.

Results: We included 203 MS patients of whom 41.9% had a raised CSF NfL concentration. NfL levels were independently associated with clinical ($P=0.02$) and MRI activity measures ($P=2.78 \times 10^{-5}$). Increased NfL levels ($N=85$) did more frequently influence DMT decisions than clinical activity ($N=81$) or imaging ($N=65$) (Figure 1). In 22 cases, the sole marker of disease activity affecting DMT decisions were NfL levels. In progressive patients, 19.8% had DMT decisions in which NfL levels were the only contributing factor compared to 3.4% in relapsing patients. Higher CSF NfL levels were associated with proactive DMT decisions ($P=7.78 \times 10^{-15}$) and their EDSS change at follow-up was not significantly different from conservatively managed patients ($P=0.78$).

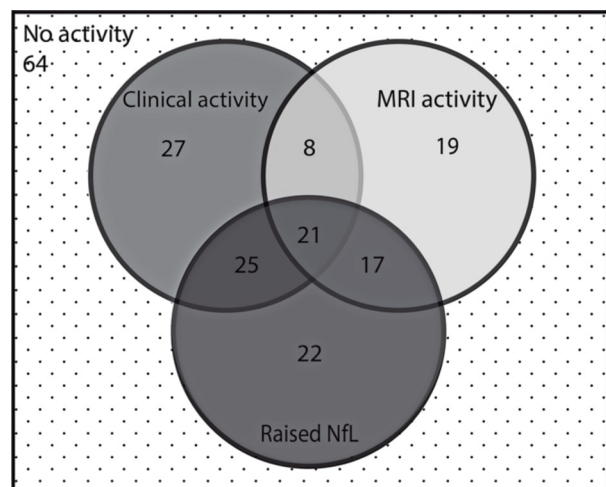

Venn-diagram illustrating how MS patients (N =203) exhibited disease activity.

Conclusion: Our data demonstrate for the 1st time that NfL levels can be integrated in routine clinical practice and complement established markers of disease activity to guide DMT decisions and improve outcome in MS patients.

Disclosure: Nothing to disclose

EPR3094

Withdrawn

EPR3095

Pregnancy outcomes in a French cohort of patients with Multiple Sclerosis: the MUSTANG project

H. Tillaut¹, S. Kerbrat¹, A. Degremont², E. Polard², E. Leray¹

¹Univ Rennes, EHESP, REPERES (Pharmacoepidemiology and health services research) – EA 7449, Rennes, France,

²Pharmacovigilance, Pharmacoepidemiology and Drug Information Centre, Department of Clinical Pharmacology, Rennes University Hospital, Univ Rennes, EA 7449 REPERES 'Pharmacoepidemiology and Health Services Research', Rennes, France

Background and aims: Since multiple sclerosis (MS) is most common in women of childbearing age, patients and neurologists are frequently confronted with questions regarding family planning and pregnancy. Pregnancy can be considered in all women with MS assuming they are provided counselling, especially to plan the use of Disease-Modifying Therapies (DMTs). Our study aims to increase knowledge about pregnancy-related issues in women with MS in France, and in particular to describe pregnancy outcomes, delivery characteristics and drug exposure.

Methods: A retrospective cohort study was performed on the French national health insurance database over the period 2010-2015 with all the 15-49 year-old, not sterile, women with MS. MS was identified if there was a long-term disease status for MS or at least one DMT reimbursement or at least one hospital admission with a diagnosis of MS. Pregnancies started between January 2010 and March 2015 were identified from their outcomes.

Results: Out of 48273 women with MS, 8466 women (18%) were pregnant at least once over the study period, accounting for 10975 pregnancies. Outcomes were 75% of live births, 17% of elective or therapeutic abortions, 5% of spontaneous abortions, 1% of ectopic pregnancies, 0.5% of stillbirths and 2% of other issues. Incidence rates of pregnancy will be calculated. Pregnancies outcomes according to DMT exposure before and during pregnancies will be described, as well as treatment stops or switches.

Conclusion: This ongoing study will provide detailed data on pregnancy-related issues in MS.

Disclosure: This work is supported by the Foundation for Multiple Sclerosis Research (ARSEP - Fondation pour l'aide à la recherche sur la sclérose en plaques).

MS and related disorders 9

EPR3096

An automated tool for assessment of multiple sclerosis lesions and brain volume - a promising addition to the visual scan inspection

S. Brune¹, E.A. Høgestøl¹, V. Cengija², P. Berg-Hansen¹, P. Sowa², G. Nygaard³, H.F. Harbo¹, M. Beyer⁴

¹Department of Neurology and Institute of Clinical Medicine, Oslo University Hospital and University of Oslo, Oslo, Norway, ²Division of Radiology and Nuclear Medicine, Oslo University Hospital, Oslo, Norway, ³Department of Neurology, Oslo University Hospital, Oslo, Norway, ⁴Division of Radiology and Nuclear Medicine and Institute of Clinical Medicine, Oslo University Hospital and University of Oslo, Oslo, Norway

Background and aims: Magnetic resonance imaging (MRI) is an important tool for the diagnosis and monitoring of multiple sclerosis (MS). We hypothesize that utilizing software designed for evaluating MRI data and providing detailed quantitative measurements in MS will provide added value to the standard neuroradiological evaluation.

Methods: We examined 56 MS patients (mean age 35 years, 70% females and 96% relapsing-remitting MS) both clinically and with brain MRI 1 and 5 years after diagnosis. The T1 and FLAIR brain MRI sequences for all patients were analysed using the LesionQuant[®] (LQ). These data were compared with data from structured visual evaluations of the MRI scans performed by a neuroradiologist, including assessments of the cortical atrophy and lesion count (>0-<10, ≥10-<20 or ≥20).

Results: Lesion count was similarly evaluated by the LQ software and the neuroradiologist in 84% (n=47) of the MS patients at 1 year after diagnosis. LQ detected a reduction in whole brain volume in 51 of 56 patients between the assessment at year 1 and 5 after diagnosis, while the neuroradiologist described 1 patient with increased cortical atrophy in the same period.

Conclusion: For the number of MS lesions we demonstrated good correlation between the assessment done by LQ and the neuroradiologist. LQ-analyses identified reduction in whole brain volume over time far better than when assessed by the neuroradiologist. In conclusion, assessment by LQ seems like a promising addition to the evaluation by the neuroradiologist, providing an automated tool for assessment of MS lesions and brain volume in MS patients.

Disclosure: The project was supported by grants from The Research Council of Norway (NFR, grant number 240102 and 223273) and the South-Eastern Health Authorities of Norway (grant number 257955 and 2019111).

EPR3097

Safety of Alemtuzumab in RRMS Patients During the Peri-infusion Period: Clinical Trial and Postmarketing Experience

P. Vermersch¹, A.D. Bass², A. Boster³, A. Chan⁴, A.J. Coles⁵, G. Comi⁶, G. Giovannoni⁷, J. Jones⁵, L. Kappos⁸, C. Laganke⁹, C. Oreja-Guevara¹⁰, F. Piehl¹¹, E. Poole¹², X. Montalban¹³

¹University of Lille, INSERM U995, CHU Lille, Lille, France, ²Neurology Center of San Antonio, San Antonio, USA, ³Boster MS Center, Columbus, USA, ⁴Bern University Hospital and University of Bern, Berne, Switzerland, ⁵University of Cambridge School of Medicine, Cambridge, United Kingdom, ⁶University Vita-Salute San Raffaele, Milan, Italy, ⁷Queen Mary University of London, Barts and The London School of Medicine, London, United Kingdom, ⁸Neurologic Clinic and Polyclinic, University Hospital and University of Basel, Basel, Switzerland, ⁹North Central Neurology Associates, Cullman, USA, ¹⁰University Hospital San Carlos, Madrid, Spain, ¹¹Neuroimmunology Unit, Department of Clinical Neuroscience, Karolinska Institutet, Stockholm, Sweden, ¹²Sanofi, Cambridge, USA, ¹³Division of Neurology, St Michael's Hospital, University of Toronto, Toronto, Canada

Background and aims: In the CARE-MS trials (NCT00530348, NCT00548405), alemtuzumab significantly improved efficacy outcomes versus subcutaneous interferon beta-1a over 2 years in RRMS patients. Here we present incidences of acute adverse events (AEs) reported during infusion and in the days following in the CARE-MS studies and postmarketing setting.

Methods: In the CARE-MS studies, all AEs and medical events of interest were recorded. Infusion-associated reactions (IARs) in clinical trials were defined as any AE with onset during or ≤24 hours after an alemtuzumab infusion. Safety monitoring continues post marketing using a Risk Management Plan/Risk Evaluation and Mitigation Strategy; acute AEs occurring within 1 week of infusion post marketing are presented.

Results: In the pooled CARE-MS studies (N=811), IARs occurred in 90% of patients; incidence of serious infections was 3%. As of 31 March, 2019, 25,292 patients had received alemtuzumab post marketing; acute AEs within 1 week of infusion post marketing included haemorrhagic stroke/pulmonary alveolar haemorrhage (reporting rate 7.1/10,000 patients treated), other stroke (0.8/10,000), myocardial infarction (MI; 2.0/10,000), and cervicocephalic arterial dissection (1.6/10,000). Reported cases of temporally associated pulmonary alveolar haemorrhage were unrelated to anti-glomerular basement membrane disease. Some patients who experienced MI were aged <40 years and had no risk factors for ischemic heart disease; some cases had temporarily abnormal blood pressure and/or heart rate during infusion.

Conclusion: Notable acute AEs temporally associated with alemtuzumab infusions were predominantly IARs and serious infections in clinical trials. Additional postmarketing events of interest included pulmonary alveolar haemorrhage, MI, stroke, and cervicocephalic arterial dissection.

Disclosure: STUDY SUPPORT: Sanofi and Bayer HealthCare Pharmaceuticals.

EPR3098

Effect of Siponimod on Grey Matter Atrophy in Patients with Secondary Progressive Multiple Sclerosis: Subgroup Analyses from the EXPAND Study

P. Vermersch¹¹, R.J. Fox¹, D.L. Arnold², G. Giovannoni³, B.A.C. Cree⁴, A. Bar-Or⁵, R. Gold⁶, R.H.B. Benedict⁷, D. Piani-Meier⁸, S. Arnould⁸, S. Ritter⁹, F. Dahlke⁸, G. Karlsson⁸, L. Kappos¹⁰

¹Mellen Center for Treatment and Research in Multiple Sclerosis, Neurological Institute, Cleveland, Ohio, USA, ²NeuroRx Research and Montréal Neurological Institute, McGill University, Montréal, Quebec, Canada, ³Blizard Institute, Barts and The London School of Medicine and Dentistry, Queen Mary University of London, London, United Kingdom, ⁴UCSF Weill Institute for Neurosciences, Department of Neurology, University of California San Francisco, San Francisco, California, USA, ⁵Center for Neuroinflammation and Experimental Therapeutics and Department of Neurology, Perelman School of Medicine, University of Pennsylvania, Philadelphia, Pennsylvania, USA, ⁶Department of Neurology, St Josef-Hospital/Ruhr-University Bochum, Bochum, Germany, ⁷Department of Neurology, University at Buffalo, Buffalo, New York, USA, ⁸Novartis Pharma AG, Basel, Switzerland, ⁹Novartis Pharmaceuticals Corporation, East Hanover, New Jersey, USA, ¹⁰Neurologic Clinic and Polyclinic, Departments of Medicine, Clinical Research, Biomedicine and Biomedical Engineering, University Hospital and University of Basel, Basel, Switzerland, ¹¹Univ. Lille, INSERMU995, CHU Lille, FHU Imminent, F-59000 Lille, France

Background and aims: Several studies suggest that grey matter (GM) atrophy is associated with long-term irreversible disability accumulation and cognitive decline. As reported previously, siponimod significantly reduced GM atrophy in patients with secondary progressive multiple sclerosis (SPMS). Here we investigated the effect of siponimod versus placebo in reducing cortical GM (cGM) and thalamic atrophy in subgroups of SPMS patients from the Phase 3 EXPAND study.

Methods: Percent volume change in cGM and the thalamus relative to baseline at Month (M)12 and M24 was assessed (EXPAND per protocol set, N=1560). The effect of siponimod versus placebo was determined using a mixed-model for repeated measures in patient subgroups defined by age and disease characteristics.

Results: In the placebo group, percentage volume change in cGM from baseline to M24 was similar across all subgroups (-1.17 to -0.94); whereas for thalamus it differed (-3.56 to -1.31) and was more pronounced in subgroups 'with gadolinium-lesion activity' (-3.56), 'active disease' (-2.15), 'age ≤45 years' (-2.12), and 'disease duration ≤15 years' (-2.09). Across the subgroups studied, siponimod reduced cGM atrophy versus placebo by 48% to 116% (p<0.01) and thalamic atrophy by 31% to 68% (p<0.05). Details on select subgroups in Table; further data on all subgroups will be presented.

Parameters	No. of patients ^a (siponimod/ placebo)	cGM		Thalamus	
		siponimod vs placebo (% relative reduction)		siponimod vs placebo (% relative reduction)	
		M12	M24	M12	M24
All patients	692/337	0.01 vs -0.60 (102%)*	-0.39 vs -1.04 (63%)*	-0.47 vs -0.94 (50%)*	-1.02 vs -1.77 (42%)*
Age ≤45 y	246/120	0.10 vs -0.61 (116%)*	-0.30 vs -0.94 (68%)*	-0.38 vs -1.16 (67%)*	-0.82 vs -2.12 (61%)*
Age >45 y	466/217	-0.04 vs -0.60 (93%)*	-0.45 vs -1.08 (58%)*	-0.53 vs -0.82 (35%)*	-1.12 vs -1.63 (31%)*
EDSS score <6	319/165	0.02 vs -0.59 (103%)*	-0.37 vs -1.04 (64%)*	-0.40 vs -0.98 (59%)*	-0.98 vs -1.71 (43%)*
EDSS score >=6	373/172	0.00 vs -0.61 (100%)*	-0.42 vs -1.04 (60%)*	-0.54 vs -0.90 (40%)*	-1.00 vs -1.88 (47%)*
Active disease ^b	347/169	-0.02 vs -0.68 (97%)*	-0.50 vs -1.14 (56%)*	-0.74 vs -1.24 (40%)*	-1.41 vs -2.15 (34%)*
Non-active disease	344/167	0.04 vs -0.53 (108%)*	-0.27 vs -0.94 (71%)*	-0.20 vs -0.63 (68%)*	-0.56 vs -1.34 (58%)*
No prior DMT	152/74	-0.08 vs -0.71 (89%)*	-0.61 vs -1.36 (55%)*	-0.79 vs -1.47 (46%)*	-1.57 vs -2.64 (41%)*
Prior DMT	540/263	0.04 vs -0.57 (100%)*	-0.33 vs -0.94 (65%)*	-0.38 vs -0.78 (51%)*	-0.85 vs -1.53 (44%)*

***p<0.0001; **p<0.001; *p<0.05

^aPer-protocol set, patients with major protocol deviations and data after the treatment switch were excluded from the analysis

^bActive disease defined as the presence of relapses in the 2 years before screening and/or ≥ T1 Gd⁺ lesion at baseline cGM, cortical grey matter; DMT, disease modifying therapy; EDSS, expanded disability status scale; Gd⁺, gadolinium enhancing; M, month

Data for additional subgroups by disease duration, presence or absence of relapses and Gd⁺ lesions will be presented in the poster

Percentage brain volume change from baseline at Month 12 and 24, as assessed by mixed model for repeated measures

Conclusion: Siponimod consistently slowed cGM and thalamic atrophy across all SPMS patient subgroups, including those with less active disease and higher disability. These effects on GM atrophy are in line with the favorable impact of siponimod on long-term clinical outcomes.

Disclosure: This study was funded by Novartis Pharma AG, Basel, Switzerland. A detailed disclosure from each author will be included in the oral/poster presentation. Abstract also submitted to AAN 2020; acceptance pending.

EPR3099

Pregnancy Outcomes in Patients Treated with Ocrelizumab

S. Vukusic¹, S. Wray², R. Buffels³, D. Zecevic³,
C. Oreja-Guevara⁴

¹Service de Neurologie et Sclérose en Plaques, Fondation EDMUS pour la Sclérose en Plaques, Hôpital Neurologique Pierre Wertheimer, Lyons, France, ²Sibyl Wray MD Neurology PC, Knoxville, TN, USA, ³F. Hoffmann-La Roche Ltd, Basel, Switzerland, ⁴Hospital Clinico San Carlos, Madrid, Spain

Background and aims: Ocrelizumab is approved for the treatment of relapsing forms of and primary progressive multiple sclerosis (MS). As many patients with MS are women of reproductive age, pregnancy outcomes in ocrelizumab-exposed patients are important.

Methods: We report analyses of pregnancies in women who received ocrelizumab in clinical trials/post-marketing sources up to 31/03/2019. Contraceptive requirements for women of childbearing potential were per label (during treatment and for 6 or 12 months after the last infusion) or adapted in clinical trials (2 methods until 6 months or 48 weeks after the last infusion/until B-cell repletion [whichever longer]). In utero exposure was defined as the last infusion occurring within 3 months of conception or during pregnancy if the date was unknown.

Results: As of 31/03/2019, a total of 362 ocrelizumab-exposed pregnancies in women with either MS (N=267), rheumatoid arthritis/systemic lupus erythematosus (N=33; clinical trials only) or an unknown indication (N=62) have been reported. Of the 267 pregnancies in women with MS (mean maternal age of 33.2 years), 118 were considered to have foetal ocrelizumab exposure (no foetal exposure, n=47; foetal exposure unknown, n=102); preliminary outcomes include: 62 live births (57 healthy babies and 5 pre-term births), 86 ongoing pregnancies, 25 elective abortions, 10 spontaneous abortions, 1 stillbirth, 3 ectopic pregnancies, 22 lost to follow-up and 58 unknown/unreported outcomes.

Conclusion: Reviewed cases to date do not suggest an increased risk of adverse pregnancy outcomes, including spontaneous abortions or malformations, with ocrelizumab treatment. The current update remains in line with previous reports.

Disclosure: Sponsored by F. Hoffmann-La Roche Ltd; writing and editorial assistance was provided by Articulate Science, UK.

EPR3100

Transactivation of endogenous retroviruses by the Epstein-Barr virus - pathophysiologically relevant key mechanism of multiple sclerosis?

L. Wieland¹, A. Emmer¹, M.E. Kornhuber¹, M. Staege²
¹Department of Neurology, University of Halle-Wittenberg, Halle, Germany, ²Clinic and Outpatient Clinic for Pediatrics I, University of Halle-Wittenberg, Halle (Saale), Germany

Background and aims: In Europe, more than 90% of all people are positive for Epstein-Barr virus (EBV) before the age of 30. Even without apparent immunodeficiency, EBV is involved in the pathogenesis of neoplasias, e.g. Hodgkin's and Burkitt's lymphomas. An association of EBV with the pathogenesis of multiple sclerosis (MS) is suggested. Interestingly, EBV seems to be able to transactivate so-called human endogenous retroviruses (HERV). If these integrated virus copies have intact open reading frames, their proteins could possibly contribute to auto-inflammatory and degenerative processes that are observed in the pathogenesis of autoimmune diseases such as MS. The hypothesized mechanism is shown (see figure attached).

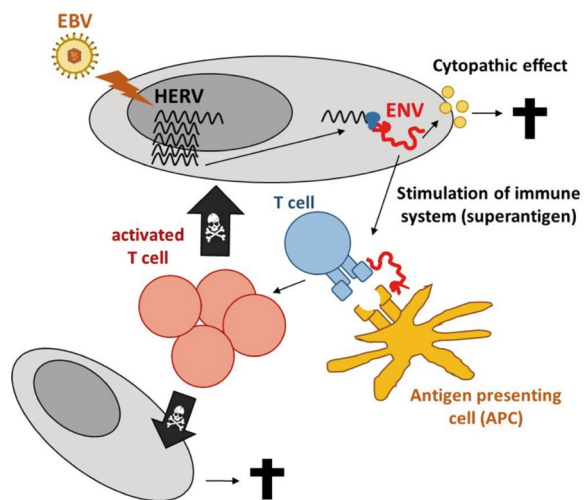

Figure following: Emmer, A., Staege, M.S., Kornhuber, M.E. The retrovirus/superantigen hypothesis of multiple sclerosis. *Cell Mol Neurobiol.* 2014, 34: 1087-1096.111

The retrovirus/superantigen-hypothesis

Methods: The expression of EBV and HERV sequences in EBV-immortalized lymphoblastoid cell lines of healthy donors (coLCL) and MS patients (MSLCL) was investigated by quantitative real-time PCR. In addition, we analyzed overall expression pattern in coLCL and MSLCL by DNA microarrays.

Results: The expression of EBV nuclear antigen 2 (EBNA2) was higher in MSLCL than coLCL. In MSLCL, a stronger correlation of EBNA2 and the lytic EBV life cycle transcripts of EBNA1 with HERV-K, -H and -W transcripts was observed. Furthermore, DNA microarray analyses showed higher transcript amounts of a known MS risk locus (HLA-DRB5, Chr. 6p21.3) in the MSLCL.

Conclusion: The study supports the hypothesis of an EBV-mediated transactivation of HERV in the pathogenesis of MS. The stronger correlation of HERV and EBV transcripts in MSLCL suggests that EBV lytic and latent programs may be regulated differently in B-cells of MS patients and healthy controls.

Disclosure: The authors declare, that the research has been granted by the Novartis Pharma GmbH.

EPR3101

Effect of Ofatumumab on B-cell Depletion and Efficacy Outcomes: Subgroup Analysis from the Pooled Phase 3 ASCLEPIOS I and II Trials

H. Wiendl¹, S.L. Hauser², A. Bar-or³, J.A. Cohen⁴, G. Comi⁵, J. Correale⁶, P.K. Coyle⁷, A.H. Cross⁸, J. De Seze⁹, D. Leppert¹⁰, X. Montalban¹¹, K. Selmaj¹², A. Kakarieka¹³, B. Li¹⁴, R. Willi¹³, D.A. Häring¹³, M. Merschhemke¹³, L. Kappos¹⁰

¹University of Muenster, Muenster, Germany, ²Department of Neurology, UCSF Weill Institute for Neurosciences, University of California San Francisco, San Francisco, California, USA, ³Center for Neuroinflammation and Experimental Therapeutics and Department of Neurology, Perelman School of Medicine, University of Pennsylvania, Philadelphia, Pennsylvania, USA, ⁴Department of Neurology, Mellen MS Center, Neurological Institute, Cleveland Clinic, Cleveland, Ohio, USA, ⁵University Vita-Salute San Raffaele, Milan, Italy, ⁶Institute for Neurological Research Dr. Raul Carrea, Buenos Aires, Argentina, ⁷Stony Brook University, Stony Brook, New York, USA, ⁸Washington University School of Medicine, Saint Louis, Missouri, USA, ⁹University Hospital of Strasbourg, Strasbourg, France, ¹⁰Neurologic Clinic and Policlinic, Departments of Medicine, Clinical Research, Biomedicine and Biomedical Engineering, University Hospital and University of Basel, Basel, Switzerland, ¹¹Department of Neurology-Neuroimmunology, Centre d'Esclerosi Múltiple de Catalunya (Cemcat), Hospital Universitari Vall d'Hebron, Barcelona, Spain, ¹²Center for Neurology, Lodz, Poland, ¹³Novartis Pharma AG, Basel, Switzerland, ¹⁴Novartis Pharmaceuticals Corporation, East Hanover, New Jersey, USA

Background and aims: Ofatumumab, the 1st fully human anti-CD20 monoclonal antibody with a monthly 20mg subcutaneous (s.c.) dosing regimen, demonstrated superior efficacy versus teriflunomide in the Phase 3 ASCLEPIOS I/II relapsing multiple sclerosis trials. We evaluated the effect of ofatumumab on B-cell depletion and efficacy outcomes in subgroups of patients defined by baseline characteristics.

Methods: In the ASCLEPIOS I/II trials, patients were randomised to receive s.c. ofatumumab 20mg (loading dose: Days 1, 7, and 14; maintenance dose: every 4 weeks from Week 4) or oral teriflunomide 14mg once-daily, for up to 30 months. B-cell numbers were determined at baseline and over the course of 96 weeks in all patients and in subgroups by quartiles of baseline body weight (kg): Q1 (<60.1), Q2 (≥60.1≤70.8), Q3 (≥70.8≤84.4), and Q4

(≥84.4). Annualised relapse rate (ARR) and 3-month/6-month confirmed disability worsening (3mCDW/6mCDW) were compared in different subgroups defined by demographics/baseline characteristics.

Results: In both the total population and across body weight subgroups, >90% of ofatumumab-treated patients achieved B-cell counts ≤40 cells/μL at Week 2, >97% at Week 4, and 96–100% over the 96 weeks. Reductions in ARR, 3mCDW and 6mCDW favoured ofatumumab versus teriflunomide across all subgroups. Similar efficacy was achieved between all subgroups; detailed data will be presented at the meeting.

Conclusion: The selected ofatumumab dosing regimen achieved rapid B-cell depletion in all patients, regardless of body weight. Furthermore, ofatumumab demonstrated similar treatment benefits across different subgroups (including body weight) consistent with the effects observed in the overall pooled ASCLEPIOS I/II population.

Disclosure: This study was funded by Novartis Pharma AG, Basel, Switzerland. A detailed disclosure from each author will be included in the oral/poster presentation. Abstract also submitted to AAN 2020; acceptance pending.

EPR3102

Early Effect of Ofatumumab on B-cell Counts and MRI Activity in Relapsing Multiple Sclerosis Patients: Results from the APLIOS Study

H. Wiendl¹, E. Fox², A. Goodyear³, I. Ludwig⁴,
M. Bagger⁴, D. Häring⁴, H. Kropshofer⁴,
M. Merschhemke⁴, A. Bar-or⁵

¹University of Muenster, Muenster, Germany, ²Central Texas Neurology Consultants and Dell Medical School, The University of Texas at Austin, Round Rock, Austin, Texas, USA, ³Novartis Pharmaceuticals Corporation, East Hanover, New Jersey, USA, ⁴Novartis Pharma AG, Basel, Switzerland, ⁵Center for Neuroinflammation and Experimental Therapeutics and Department of Neurology, Perelman School of Medicine, University of Pennsylvania, Philadelphia, Pennsylvania, USA

Background and aims: Ofatumumab, the 1st fully human anti-CD20 monoclonal antibody with a monthly 20mg subcutaneous (s.c.) dosing regimen, of gadolinium-enhancing (Gd⁺) lesions versus teriflunomide in the Phase 3 ASCLEPIOS I/II relapsing multiple sclerosis (RMS) trials. We evaluated the onset of ofatumumab effect on B-cell depletion and magnetic resonance imaging activity in RMS patients in APLIOS.

Methods: APLIOS was a 12-week, open-label, Phase 2 bioequivalence study in 284 patients who received ofatumumab 20mg (0.4mL) s.c. loading doses on Days 1, 7 and 14, and a maintenance dose every 4 weeks (starting at Week 4) via an autoinjector pen (SensoReady) or a prefilled syringe. Suppression of CD19⁺ B-cells and Gd⁺ lesions was serially assessed over 12 weeks.

Results: Ofatumumab rapidly depleted circulating B-cells, from a median B-cell count of 219 cells/ μ L (Day 1) to 10 cells/ μ L (Day 4) and 1 cell/ μ L by the end of the loading regimen (Week 4); the proportion of patients with B-cell counts of <10 cells/ μ L over 12 weeks is presented in Figure. Ofatumumab reduced the mean number of Gd⁺ lesions from 1.5 (baseline) to 0.8, 0.3 and 0.1 by Weeks 4, 8 and 12, respectively; the proportions of patients free from Gd⁺ lesions at the corresponding time points were 66.5%, 86.7% and 94.1%.

Figure. Median B cell counts with ofatumumab treatment and the proportion of patients with B cells <10 cells/ μ L over 12 weeks

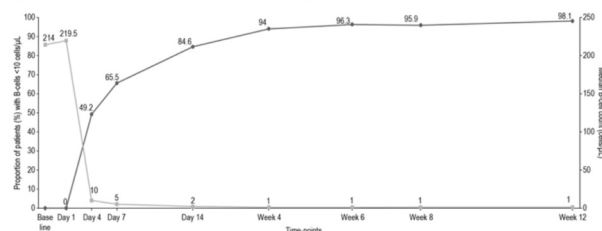

Median B-cell counts with ofatumumab treatment and the proportion of patients with B-cells <10 cells/ μ L over 12 weeks

Conclusion: Ofatumumab treatment resulted in a rapid, close-to-complete and sustained B-cell depletion over 12 weeks, leading to a profound reduction of Gd⁺ lesions in

RMS patients, consistent with the effects observed in the pooled Phase 3 ASCLEPIOS I/II population.

Disclosure: This study was funded by Novartis Pharma AG, Basel, Switzerland. A detailed disclosure from each author will be included in the oral/poster presentation. Abstract also submitted to AAN 2020; acceptance pending.

EPR3103

Deep Grey Matter and Thalamic Nuclei Volume Loss Correlation With Whole-Brain Volume Loss in Patients With MS From the TEMSO Study

J. Wuerfel¹, S. Magon², M.M. Chakravarty³, L. Kappos⁴, N. Roesch⁵, E. Poole⁵, T. Sprenger⁴

¹Department of Biomedical Engineering, University of Basel, Basel, Switzerland, ²Medical Image Analysis Center (MIAC AG), Basel, Switzerland, ³Cerebral Imaging Centre, Douglas Mental Health University Institute, Montreal, Canada,

⁴Neurologic Clinic and Policlinic, University Hospital Basel, Basel, Switzerland, ⁵Sanofi, Cambridge, USA

Background and aims: Volume loss in deep grey matter (DGM) may correlate with disability progression and cognitive impairment in MS. Here, we examine the correlation of DGM and thalamic nuclei with whole-brain volume (WBV) changes over 2 years in placebo-treated patients from the TEMSO study (NCT00134563).

Methods: Blinded post hoc analysis of a randomly selected subset of placebo-treated patients was carried out by the Medical Image Analysis Center (Basel, Switzerland). The multiple automatically generated templates (MAGeT) algorithm measured nuclei volumes; structural image evaluation using normalisation of atrophy (SIENA) measured WBV. Spearman correlation analysis assessed the relationships between changes in nuclei and WBV over 2 years.

Results: Of 98 placebo-treated patients selected for analysis, 95 (97%) had evaluable data at Year 2; WBV loss was 1.37% over 2 years from baseline. Median volume losses in the nuclei ranged from 0%–5.52%, with the globus pallidus (5.52%) and pulvinar (4.51%) showing the greatest losses. Most nuclei volume losses significantly correlated with WBV loss at Year 2, and were highest for the pulvinar (Spearman coefficient for volume change at Year 2, 0.478; $P < 0.0001$), striatum (0.454; $P < 0.0001$), and central nuclei (0.440; $P < 0.0001$); however, the medial geniculate nucleus (0.173; $P = 0.0937$), anterior nuclei (0.114; $P = 0.2717$), and lateral geniculate nucleus (0.063; $P = 0.5445$) were not correlated with WBV loss.

Conclusion: Over 2 years, WBV loss in placebo-treated patients significantly correlated with nuclei volume losses, most strongly with the pulvinar, striatum, and central nuclei. These findings suggest MS impacts nuclei at variable rates, and potentially identify regions driving disability progression.

Disclosure: STUDY SUPPORT: Sanofi.

EPR3104

Preservation of relapse-free status in Year 2 of treatment with cladribine tablets by relapse-free status in Year 1

B. Yamout¹, G. Giovannoni², M. Magyari³, P. Vermersch⁴, E. Merino-Plaza⁵, N. Alexandri⁵, B. Keller⁵

¹American University of Beirut Medical Center, Beirut, Lebanon, ²Queen Mary University of London, Blizard Institute, Barts and The London School of Medicine and Dentistry, London, United Kingdom, ³Danish Multiple Sclerosis Center and The Danish Multiple Sclerosis Registry, Copenhagen University Hospital, Copenhagen, Denmark, ⁴Univ. Lille, INSERM U1172, CHU Lille, FHU Imminent, Lille, France, ⁵Merck KGaA, Darmstadt, Germany

Background and aims: Cladribine tablets (CT) are administered as 2 short courses at the beginning of Year-1 and 2. CT modelling data demonstrated a reduction in efficacy when the dose is < 3.5 mg/kg of body weight; a practical question for physicians is whether to continue treatment in Year-2 if patients experience disease activity in Year-1.

Methods: CLARITY was a 2-year placebo-controlled phase III study of CT in patients with relapsing-remitting multiple sclerosis. Relapse status in Year-2 was stratified by relapse status in Year-1.

Results: Of 433 patients randomised to CT 3.5 mg/kg, 353 (81.5%) did not experience a relapse in Year-1; 60 (13.9%) experienced ≥ 1 relapse; 4.6% unknown. In patients relapse-free in Year-1, 324 (91.8%) were relapse-free in Year-2; 25 (7.1%) experienced ≥ 1 relapse. In patients with ≥ 1 relapse in Year-1, 37 (61.7%) were relapse-free in Year-2; 17 (28.3%) experienced ≥ 1 relapse in Year-2. Of 437 patients receiving placebo, 299 (68.4%) were relapse-free in Year-1; 111 (25.4%) experienced ≥ 1 relapse; 6.2% unknown. In patients relapse-free in Year-1 in the placebo group, 233 (77.9%) were relapse-free in Year-2; 54 (18.1%) experienced ≥ 1 relapse. In patients in the placebo group who experienced a relapse in Year-1, 58 (52.3%) were relapse-free in Year-2; 38 (34.2%) experienced ≥ 1 relapse in Year-2.

Conclusion: Over 60% of patients who experienced a relapse in Year-1 of CT treatment were relapse free in Year-2, supporting the recommended dose of CT 3.5 mg/kg over 2 years for maximum treatment effect.

Disclosure: This study was sponsored by Merck KGaA, Darmstadt, Germany.

EPR3105

Long-term follow up of an Italian cohort of pediatric Multiple Sclerosis patients: real world data from San Raffaele Hospital.

C. Zanetta, E. De Meo, F. Sangalli, V. Martinelli, G. Comi, L. Moiola, M. Filippi
Department of Neurology, San Raffaele Hospital, Milan, Italy

Background and aims: Multiple Sclerosis (MS) during childhood occurs in 3-10%. Pediatric MS (ped-MS) has a relapsing-remitting course and high relapse rate. Data on disease modifying treatments (DMTs) in ped-MS are scarce. We present baseline characteristics and long-term follow up (FU) of an Italian cohort of ped-MS subjects.

Methods: Data regarding MS onset, annualized relapse rate (ARR), Expanded Disability Status Scale (EDSS) score and treatments were collected at San Raffaele Hospital.

Results: 144 patients (101 females) were included, mean age at onset and at last FU were 14.4±2.6 and 24.7±6.1 years. 109 subjects had a monofocal onset. Mean ARR and median EDSS at onset were 4.5±4.9 and 1.5 (0-6). Mean FU was 9.8±6.6 years. Mean age at therapy initiation was 15.1±2.1 years and 59.7% of subjects were initially treated with interferon-beta (IFN). Induction was performed in 4.9%, while second-line treatments as 1st therapy were chosen in 17.4%. 50.5% of subjects were treated with Natalizumab, 13.2% as 1st therapy. 82.6% underwent at least 1 switch, the 1st after a mean of 2.3±3.3 years, predominantly to high-frequency IFN; subsequent switches were to 2nd-line therapy. ARR was reduced during 1st treatment (from 4.4±4.7 to 0.8±1.8) and last FU (0.02±0.1), $p > 0.001$ in both instances. 15.3% of subjects had an EDSS worsening, 76% had no evidence of clinical disease activity at last FU.

Conclusion: Ped-MS patients benefited from 1st-line agents, but the majority had to switch to more powerful DMTs. Our findings highlight the importance of treatment selection and accurate clinical FU in ped-MS population.

Disclosure: Nothing to disclose

EPR3106

Kallikrein 6, an emerging pharmacological target to promote remyelination in Multiple Sclerosis

S. Zeidan¹, R. Panic¹, C. Deboux¹, S. Aït Amiri², C. El Amri², B. Nait Oumesmar¹

¹*Institut du Cerveau et de la Moelle Epinière, Inserm U1127, CNRS UMR 7225, Sorbonne Université, Hôpital Pitié-Salpêtrière, Paris, France*, ²*Institut de Biologie Paris Seine, CNRS UMR 8256, Sorbonne Université, INSERM U1164, Paris, France*

Background and aims: In Multiple Sclerosis (MS), treatments promoting remyelination are still an unmet medical need. Remyelination is achieved by oligodendrocyte precursor cells (OPCs) which regenerate myelinating oligodendrocytes. Kallikrein 6 (Klk6), a serine protease mainly secreted by mature oligodendrocytes, is increased in MS lesions, and impairs oligodendrocytes' maturation in vitro. Neutralizing antibodies or loss-of-function of klk6 reduce the severity of mouse models of MS. Therefore, Klk6 could be an interesting target to enhance remyelination in MS.

Methods: We studied Klk6 expression in a mouse model of focal demyelination and assessed the effects of a specific reversible Klk6 inhibitor on remyelination. Focal demyelination was induced by injection of lysophosphatidylcholine (LPC) in the dorsal funiculus of thoracic spinal cord of C57BL6/J mice. Immunohistochemistry targeting Klk6 and glial markers was performed during spontaneous remyelination. Another group was treated with the Klk6 inhibitor (330µg/kg, ip) or a vehicle between 5 and 14 days post injection (dpi), and oligodendroglial cells were quantified.

Results: In normal appearing white matter, Klk6 co-localized mostly with mature oligodendrocytes. In LPC lesions, Klk6 expression increased at 7-21 dpi and co-localized mainly with microglial markers. The density of differentiated oligodendrocytes was lower in the Klk6 inhibitor-treated group (450.8/mm² vs. 802.1/mm², $p = 0.015$), and these cells were mainly at the periphery of the lesions as compared to controls.

Conclusion: Klk6 expression is associated with neuroinflammation in LPC demyelinating lesions. Klk6 inhibitors may impair OPC differentiation and migration following demyelination. Klk6 and related proteolytic pathways could be a new therapeutic target for enhancing remyelination in MS.

Disclosure: Nothing to disclose

EPR3107

Alemtuzumab Outcomes Over 9 Years in RRMS Patients With Highly Active Disease From CARE-MS I and II (TOPAZ)

T. Ziemssen¹, A.D. Bass², R. Berkovich³, S. Eichau⁴, J. Hobart⁵, S.F. Hunter⁶, V. Limmroth⁷, D. Pelletier⁸, C. Pozzilli⁹, S. Schippling¹⁰, B.A. Singer¹¹, L. Sousa¹², A. Traboulsee¹³, B.M.J. Uitdehaag¹⁴, B. Van Wijmeersch¹⁵, E.M. Poole¹⁶, Z. Choudhry¹⁶, S. Geertsen¹⁷, N. Daizadeh¹⁶, G. Comi¹⁸

¹Center of Clinical Neuroscience, Carl Gustav Carus University Hospital, Dresden, Germany, ²Neurology Center of San Antonio, San Antonio, USA, ³Regina Berkovich, MD, PhD, Inc., West Hollywood, USA, ⁴Hospital Universitario Virgen Macarena, Seville, Spain, ⁵Plymouth University Peninsula Schools of Medicine and Dentistry, Plymouth, United Kingdom, ⁶Advanced Neurosciences Institute, Franklin, USA, ⁷Klinik für Neurologie und Palliativmedizin, Cologne, Germany, ⁸Keck School of Medicine of University of Southern California, Los Angeles, USA, ⁹Department of Human Neuroscience, Sapienza University of Rome, Rome, Italy, ¹⁰University Hospital Zürich and University of Zürich, Zurich, Switzerland, ¹¹MS Center for Innovations in Care, Missouri Baptist Medical Center, St. Louis, USA, ¹²Centro Hospitalar e Universitário de Coimbra, Coimbra, Portugal, ¹³University of British Columbia, Vancouver, Canada, ¹⁴Amsterdam University Medical Centers, Amsterdam, Netherlands, ¹⁵Rehabilitation and MS-Centre Overpelt, BIOMED, Hasselt University, Hasselt, Belgium, ¹⁶Sanofi, Cambridge, USA, ¹⁷Sanofi, Copenhagen, Denmark, ¹⁸University Vita-Salute San Raffaele, Milan, Italy

Background and aims: Alemtuzumab efficacy and safety over 9 years were evaluated in patients from the CARE-MS and extension studies (NCT00530348, NCT00548405, NCT00930553, NCT02255656) that were previously treated with disease-modifying therapy and fulfilled highly active disease (HAD) criteria.

Methods: Analysis populations: CARE-MS II patients with HAD at core study baseline (9 total years; ≥ 2 relapses in the year prior to study start and ≥ 1 gadolinium [Gd]-enhancing lesion at baseline [definition 1], or ≥ 1 relapse in prior year and ≥ 1 Gd-enhancing lesions [definition 2]), and pooled CARE-MS I/II patients treated with subcutaneous interferon beta-1a (SC IFNB-1a) in the core study with HAD at extension baseline (7 total years; ≥ 1 relapses in prior year and ≥ 1 Gd-enhancing lesions OR ≥ 9 T2 lesions at baseline [definition 3]).

Results: In Years 0-2, annualised relapse rate (ARR) was decreased with alemtuzumab versus SC IFNB-1a (0.33 vs 0.65, $P=0.004$ [definition 1; $n=103$]; 0.28 vs 0.61, $P<0.0001$ [definition 2; $n=180$]). ARR remained low in Years 3-9 (0.16, 0.17, and 0.25, respectively, for patients meeting definitions 1, 2, and 3 [$n=23$]). Through Year 9, 49%-59% of HAD patients achieved 6-month confirmed disability improvement, and 55%-64% remained free of 6-month confirmed disability worsening after alemtuzumab. Median cumulative brain volume loss ranged from -0.64% to -1.80%. Serious adverse events in HAD patients were

similar to those in the overall population (39.8%-47.8% vs 44.8%).

Conclusion: Alemtuzumab improved outcomes versus SC IFNB-1a over 2 years in HAD patients, with maintained efficacy up to 9 years. Safety in HAD patients was similar to that in the overall study population.

Disclosure: STUDY SUPPORT: Sanofi

Muscle and neuromuscular junction disease 3

EPR3108

Development of new biomarkers for Spinal Muscular Atrophy (SMA) type III and IV: a multimodal longitudinal study.

G. Querin¹, T. Lenglet², R. Debs², V. Marchand-Pauvert³, T. Stojkovic⁴, A. Béhin⁴, P. Laforet⁵, F. Salachas², P. Bede⁶, J.-Y. Hogrel⁷, P.-F. Pradat⁸

¹Institut de Myologie, APHP-GH Pitié Salpêtrière, Paris, France, ²Paris, France, ³Laboratoire d'Imagerie Biomédicale, CNRS, INSERM, Sorbonne Université, Paris, France, Paris, France, ⁴Institut de Myologie, G.H. Pitié-Salpêtrière, Paris, France, ⁵Garches, France, ⁶Academic Unit of Neurology, Trinity College Dublin, Dublin, Ireland, ⁷Institute of Myology, Pitié-Salpêtrière Hospital, Paris, France, ⁸Paris Cedex 13, France

Background and aims: Aim of this study was the comprehensive characterisation of longitudinal clinical, electrophysiological and neuroimaging measures in type III and IV adult spinal muscular atrophy (SMA) to propose objective monitoring markers for future clinical trials.

Methods: 14 patients with type III or IV SMA underwent standardised assessments including muscle strength testing, dynamometry, functional evaluation (SMAFRS and MFM), MUNIX (abductor pollicis brevis; abductor digiti minimi, ADM; deltoid, tibialis anterior, TA; trapezius) and quantitative cervical spinal cord MRI to appraise segmental grey and white matter atrophy. Patients underwent a follow-up assessment with the same protocol 24 months later. Longitudinal comparisons were conducted using the Wilcoxon-test for matched data. Responsiveness was estimated as standardized response means (SRM) value and a composite score was generated based on the three most significant parameters.

Results: Significant functional decline was observed based on SMAFRS ($p=0.019$), pinch and knee flexion force ($p=0.030$ and 0.027), MUNIX and MUSIX value in the ADM ($p=0.0006$ and 0.043) and in TA muscle ($p=0.025$). No significant differences were observed based on cervical MRI measures. A significant reduction was detected in the composite score ($p=0.0005$, $SRM=-1.52$), which was the most responsive parameter and required a smaller number of patients in the estimation of sample size for clinical trials.

Conclusion: Quantitative force testing, SMAFRS and MUNIX readily capture disease progression in adult SMA patients. Composite multimodal scores increase predictive value and may reduce sample size requirements in clinical trials.

Disclosure: This study was sponsored by the Association française contre les myopathies (AFM-Téléthon).

EPR3109

Safety and Effectiveness of Eculizumab for Patients with Generalized Myasthenia Gravis in Japan: Interim Analysis of Post-Marketing Surveillance

H. Murai¹, S. Suzuki², M. Hasebe³, Y. Fukamizu³, E. Rodrigues⁴, K. Utsugisawa⁵

¹International University of Health and Welfare, Narita, Japan, ²Keio University School of Medicine, Tokyo, Japan, ³Alexion Pharma GK, Tokyo, Japan, ⁴Alexion Pharmaceuticals, Inc, Boston, USA, ⁵Hanamaki General Hospital, Hanamaki, Japan

Background and aims: Eculizumab, a humanised monoclonal antibody targeted to terminal complement protein C5, is approved in Japan for treatment of patients with anti-acetylcholine receptor antibody-positive (AChR+) generalised myasthenia gravis (gMG) whose symptoms are difficult to control with high-dose intravenous immunoglobulin (IVIg) or plasmapheresis.

Methods: In Japan, all patients with gMG receiving eculizumab undergo post-marketing surveillance. This interim analysis assessed safety and effectiveness after 26 weeks of eculizumab treatment (data cut-off, October 2019).

Results: Data are available for 40 adult patients in Japan (female, 62.5%; mean age at eculizumab initiation, 51.0 years). 8 patients discontinued eculizumab during the 26-week follow-up. 1 patient with type 2 diabetes and hypertension died 10 days after the 1st eculizumab infusion due to atrial fibrillation and acute myocardial infarction (causal relationship with treatment unclear). Adverse drug reactions were reported by 7 patients (most frequently headache [n=3]). No meningococcal infections have been reported. The proportion of patients receiving ≥ 1 IVIg treatment/plasmapheresis decreased from 50.0%/35.0%, respectively, in the 6 months before eculizumab initiation to 12.5%/10.0%, respectively, during the 6 months after initiation. Frequency of IVIg use also decreased following eculizumab initiation (Figure 1). Mean (standard deviation) changes from baseline in MG-Activities of Daily Living and Quantitative MG scores were -3.7 (2.61) (n=27) and -5.6 (3.50) (n=26), respectively, at 12 weeks, and -4.3 (2.72) (n=26) and -5.6 (4.02) (n=24), respectively, at 26 weeks.

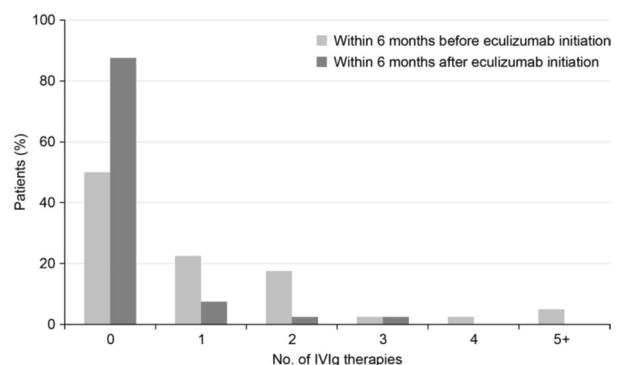

Figure 1. Use of IVIg before and after eculizumab initiation

Conclusion: In a real-world setting, eculizumab was effective and well tolerated for treatment of AChR+ gMG in adult Japanese patients who were refractory to IVIg or plasmapheresis.

Disclosure: This study was conducted by Alexion Pharma GK.

EPR3110

NEO1/NEO-EXT studies: Trends over time in exploratory efficacy of repeat avalglucosidase alfa dosing for up to 5.5 years in late-onset Pompe disease (LOPD) patients

B. Schoser¹, R.J. Barohn², B.J. Byrne³, O. Goker-Alpan⁴, P.S. Kishnani⁵, S. Ladha⁶, P. Laforet⁷, K.E. Mengel⁸, L.D.M. Pena⁹, S. Sacconi¹⁰, V. Straub¹¹, J. Trivedi¹², P. Van Damme¹³, A.T. Van der Ploeg¹⁴, J. Vissing¹⁵, P. Young¹⁶, K. An Haack¹⁷, C. Fleurinck¹⁸, J. Johnson¹⁹, K. Liu²⁰, M.M. Dimachkie;

On Behalf Of The Neo-Ext Investigators²

¹Friedrich-Baur-Institut, Department of Neurology Klinikum München, Munich, Germany, ²University of Kansas Medical Center, Kansas City, USA, ³University of Florida, Gainesville, USA, ⁴O&O Alpan LLC, Fairfax, USA, ⁵Duke University Medical Center, Durham, USA, ⁶Barrow Neurological Institute, Phoenix, USA, ⁷Centre de Référence des Maladies Neuromusculaires Nord/Est/Ile de France Service de Neurologie, Hôpital Raymond-Poincaré, Garches, AP-HP and INSERM U1179, Université Versailles Saint-Quentin-en-Yvelines, Montigny-le-Bretonneux, France, ⁸Villa Metabolica, Centre for Pediatric and Adolescent Medicine, University Medical Center, Mainz, Germany, ⁹At time of the study: Duke University Medical Center, Durham/USA & Current affiliation: Cincinnati Children's Hospital Medical Center and University of Cincinnati College of Medicine, Cincinnati, USA, ¹⁰Neuromuscular Diseases Centre, Department of Clinical Neurosciences, University Hospital of Nice (CHU), Nice, France, ¹¹Newcastle University John Walton Muscular Dystrophy Research Centre, Newcastle Hospitals NHS Foundation Trust, Newcastle Upon Tyne, United Kingdom, ¹²University of Texas Southwestern Medical Center, Dallas, USA, ¹³KU Leuven (Catholic University of Leuven) - Department of Neurosciences, VIB - Center for Brain & Disease Research, and University Hospitals Leuven - Department of Neurology, Leuven, Belgium, ¹⁴Erasmus MC University Medical Center, Pompe Center & Center for Lysosomal and Metabolic Diseases, Rotterdam, Netherlands, ¹⁵Copenhagen Neuromuscular Center, Rigshospitalet, University of Copenhagen, Copenhagen, Denmark, ¹⁶Department of Sleep Medicine and Neuromuscular Disorders, Universitätsklinikum Münster, Münster, Germany, ¹⁷Sanofi Genzyme, Chilly-Mazarin, France, ¹⁸Ablynx, A Sanofi Company, Ghent, Belgium, ¹⁹Sanofi Genzyme, Cambridge, USA, ²⁰Sanofi Genzyme, Bridgewater, USA

Background and aims: In NEO-EXT (NCT02032524), an ongoing NEO1 (NCT01898364) extension, long-term avalglucosidase alfa is being assessed in LOPD patients

who at NEO1 enrolment, were either naïve to enzyme replacement therapy (Naïve) or had received ≥ 9 months' avalglucosidase alfa (Switch). Analyses for exploratory efficacy trends over time are reported.

Methods: NEO1 patients received avalglucosidase alfa (5, 10, or 20mg/kg qow) for 6 months. In NEO-EXT, patients initially continued their NEO1 dose; transitioning to 20mg/kg during 2016. Repeated mixed measures model of pooled data (patients ever received 20mg/kg) analysed efficacy trends over up to 5.5 years' avalglucosidase alfa.

Results: 24 patients (age 20–78 years) enrolled in NEO1 (10 Naïve; 14 Switch), 19 continued to NEO-EXT (8 Naïve, 11 Switch), and 17 remained as of July 2019 (7 Naïve, 10 Switch); 2 NEO-EXT withdrawals (personal reasons). After 5.5 years, >2400 avalglucosidase alfa infusions had been received. Table 1 shows slope estimates for efficacy parameters. Upright % predicted FVC remained stable at the group level and in most patients. Upright % predicted MIP and MEP were more variable among individual patients, but remained stable overall. % predicted 6MWT distance remained stable among most patients in both groups. Improvement in 6MWT was observed in patients aged ≤ 50 years at NEO1 enrolment, in both groups. Avalglucosidase alfa was generally well-tolerated, and the safety profile in NEO-EXT consistent with NEO1.

	Slope (years)	
	Naïve patients (N=7)	Switch patients (N=12)
	Estimate (95% CI)	Estimate (95% CI)
FVC, % predicted	0.396 (-0.351, 1.144)	-0.331 (-0.778, 0.115)
MIP, % predicted	0.743 (-0.613, 2.100)	-0.946 (-2.001, 0.110)
MEP, % predicted	0.698 (-0.692, 2.088)	1.192 (-0.148, 2.531)
6MWT, distance walked, % predicted	-0.965 (-1.891, -0.038)	-1.216 (-2.027, -0.405)

6MWT, 6-minute walk test; CI, confidence interval; FVC, forced vital capacity; MEP, maximum expiratory pressure; MIP, maximum inspiratory pressure.
Random intercept model assuming an unstructured covariance structure with time (years) as fixed effect and intercept as random effect.

Table 1: Estimates of linear mixed effect model – efficacy analysis set (patients ever received 20 mg/kg avalglucosidase alfa for up to 5.5 years)

Conclusion: After up to 5.5 years' avalglucosidase alfa, efficacy analyses showed that patients had sustained benefit on pulmonary and motor function. Funding: Sanofi Genzyme.

Disclosure: This study was supported by Sanofi Genzyme.

EPR3111

Respiratory Function and Ambulation Status Assessments of Late-onset Pompe Disease Patients with and without the Common IVS1 Variant from the Pompe Registry

B. Schoser¹, M.-A. Abbott², T. Mongini³, D. Stockton⁴, R. Araujo⁵, A. Van der Ploeg⁶

¹Department of Neurology, Friedrich-Baur-Institute, Munich, Germany, ²Department of Pediatrics, Baystate Children's Hospital, Springfield, USA, ³University of Turin, Department of Neuroscience, Center for Neuromuscular Diseases, Turin, Italy, ⁴Division of Genetic, Genomic and Metabolic Disorders, Departments of Pediatrics and Internal Medicine, Wayne State University and Children's Hospital of Michigan, Detroit, USA, ⁵Sanofi Genzyme, Cambridge, USA, ⁶Center for Lysosomal and Metabolic Diseases, Department of Pediatrics, Erasmus MC, University Medical Center Rotterdam, Rotterdam, Netherlands

Background and aims: The most common disease-causing variant of late-onset Pompe disease (LOPD) is the c. 32 13T>G (IVS1) splice-site variant, which leads to a reduced acid alpha-glucosidase protein production of about 10-20% residual GAA activity.

Methods: We described patient characteristics by IVS1 status and compared respiratory function and ambulation status at baseline among patients with available data in IVS1 and non-IVS1 patients in the Pompe Registry (NCT00231400; sponsored by Sanofi Genzyme).

Results: Of 980 LOPD patients, 793 (80.9%) had 1 or 2 copies of IVS1: 66.7% came from Europe, 30.9% from North America, and 1.3% from Asia-Pacific. For non-IVS1 patients (n=187), 39.0% were in Europe, 38.5% in North America, and 19.8% in Asia-Pacific. IVS1 vs. non-IVS1 patients were older at symptom onset (median: 34.2 vs. 4.5 years), diagnosis (41.5 vs. 7.9 years), and enzyme replacement therapy (ERT) initiation (45.5 vs. 11.8 years). Non-IVS1 patients were slightly more likely than IVS1 patients to be on respiratory support at ERT initiation (25.0% vs. 17.1%, respectively). Median baseline forced vital capacity (FVC) values were similar (IVS1=72.0%; non-IVS1=66.5%). Most IVS1 (95.6%) and non-IVS1 (85.4%) patients were ambulatory at ERT initiation. Ambulation device use at ERT initiation was similar (IVS1=14.2% vs. non-IVS1=13.2% patients). 23 IVS1 patients were homozygous. For heterozygous IVS1 patients (n=770), the most frequent type of 2nd variant was substitution (missense). At baseline, no significant differences in clinical characteristics were observed in heterozygous IVS1 patients when grouped by second variant type.

Conclusion: Our data provide additional insights into the most common disease mutation variant of LOPD.

Disclosure: This analysis was funded by Sanofi Genzyme.

EPR3112

Clinical characterization of a cohort of 30 BMD patients: stratification of patients towards trial readiness

A. Govoni¹, G. Ricci¹, V. Castiglione², G. Astrea³, A. Rocchi¹, F. Baldinotti⁴, A. Giannoni², M. Emdin², C. Passino⁵, G. Siciliano¹

¹Department of Clinical and Experimental Medicine, University of Pisa, Pisa, Italy, ²Fondazione Toscana Gabriele Monasterio, Pisa, Italy, ³IRCCS Stella Maris, Pisa, Italy, ⁴Laboratory of Medical Genetics, Azienda Ospedaliero-Universitaria Pisana, S. Chiara Hospital, Pisa, Italy, ⁵Cardiology Division, Fondazione Toscana Gabriele Monasterio, Pisa, Italy

Background and aims: Becker muscular dystrophy (BMD) is characterized by a broad phenotypic spectrum. We propose a clinical protocol aimed to describe genetic, muscular and cardiac involvement, to identify different clinical subgroups and stratify patients towards trial readiness.

Methods: We recruited 30 adult BMD patients, for each one we collected medical history and we assess at baseline and after 1-year motor function scales: North Star Ambulatory Assessment, timed function tests, 6-minute walk test, Walton and Gardner-Medwin Scale and MRC scale. Skeletal muscle involvement was studied by standard muscle MRI with qualitative analysis. A comprehensive assessment of cardiac involvement was performed on 10 BMD patients, aged 39±19 years, through cardiac magnetic resonance (CMR) and study of blood biomarkers (troponin T and I, NT-proBNP, norepinephrine, myoglobin and creatine-kinase) of cardiac and muscular damage.

Results: In a 1-year follow-up period, motor functions measures did not show significant evolution of the disease. Muscular MRI was useful to recognize a specific pattern of muscle involvement, related to different mutations. The cardiological characterization allowed to detect that myocardial fibrosis as assessed by late gadolinium enhancement (LGE) was present in 6 patients (60%) with 3 patients demonstrating reduced left ventricular ejection fraction. The same LGE-positive patients showed a trend towards higher values of cardiological blood biomarker.

Conclusion: Genotype-phenotype correlation studies with a detailed clinical characterization are needed to better define prognosis and to identify biomarkers of progression and outcome measures toward trial readiness. In this framework, CMR through LGE can allow early identification of cardiac involvement in BMD.

Disclosure: Nothing to disclose

EPR3113

Myasthenia gravis in Poland – national healthcare database epidemiological study

E. Sobieszczuk¹, Ł. Napiórkowski², P. Szczudlik¹,
A. Kostera-Pruszczyk¹

¹Neurology, Medical University of Warsaw, Warsaw, Poland,

²Department of Analyses and Innovation, National Health Fund, Warsaw, Poland

Background and aims: Myasthenia gravis (MG) is a rare autoimmune disorder of neuromuscular junction. MG epidemiology has not been studied in Poland in a nationwide study before.

Methods: Our epidemiological data was drawn from the National Health Fund (NFZ) database; MG patient was defined as a person who received at least once medical service coded in ICD-10 as myasthenia gravis (G70) and at least 2 reimbursed prescriptions for pyridostigmine bromide (Mestinon[®]) or ambenonium chloride (Mytelase[®]) in 2 consecutive years.

Results: On 1st January 2019, 8702 patients with MG were receiving symptomatic treatment (female:male ratio 1.65:1). MG incidence was 2.36/100,000. Mean age of incident cases in 2018 was 61.05 years, 59.17 years for women, and 64.12 years for men. Incidence of early onset MG (EOMG, <50y) was 0.80/100,000, and 4.98/100,000 for late-onset MG (LOMG), with male predominance in LOMG. Prevalence in patients <50 years old was 9.21/100,000, and 45.34/100,000 in patients ≥50 years old, in total 22.65/100,000. The highest prevalence was observed in the age group of 80-89 years old: 59.65/100,000 in women, 96.25/100,000 in men. In women, there was a constant increase in prevalence of symptomatic MG from the 1st decade of life up to 80-89 years. In men, an increase in prevalence appeared in the 6. decade.

Conclusion: Our findings provide information on epidemiology of symptomatic Myasthenia Gravis in Poland and can serve as a tool to evaluate health care resources needed for MG patients.

Disclosure: Nothing to disclose

EPR3114

The risk factors for developing refractory Myasthenia gravis

K. Sviatlana, S. Likhachev, T. Hvishch, E. Osos
Department of Neurology, Republican Research and Clinical Center of Neurology and Neurosurgery, Minsk, Belarus

Background and aims: Most patients with Myasthenia gravis (MG) are successfully treated with acetylcholinesterase inhibitors, corticosteroids, and/or steroid sparing agents such as azathioprine and mycophenolate mofetil. We can say about refractory MG when there is insufficient response (e.g. persistent moderate to severe weakness) to maximal safe doses of steroids and at least one immunosuppressive drug at adequate dose and duration.

Methods: We analyzed the history of the disease in 1275 patients with generalized MG, 98 (7.7%) of them had a refractory course. 98 patients with refractory MG were compared with 775 patients with non-refractory MG.

Results: Refractory MG was characterized by: a statistically significant predominance of women (79.6% vs. 69.6%, p=0.039), an earlier age of onset of the disease (40.8 years vs. 47.1 years, p=0.003), the myasthenic crisis developed more often (29.5% of patients vs. 7.1%, p=0.000), there were more common repeated myasthenic crises (in 20.7% of cases vs. 3.6%, p=0.011), the group average level of the titers of antibodies to acetylcholine receptors were higher (27nmol/l vs. 13.2nmol/l, p=0.002). The presence of thymoma and thymectomy were equally often observed in both groups (12.4% vs. 14.3%, p=0.51 and 27.5% vs. 30.3%, p=0.47 respectively). The absence of antibodies to acetylcholine receptors was also equally common in both groups (15.4% vs. 20.4%, p=0.39). 18.3% of patients with refractory MG and 18.9% of patients with non-refractory MG had concomitant autoimmune diseases (p=0.93).

Conclusion: Female patients, early onset of the disease, and myasthenic crisis are the risk factors for developing refractory MG.

Disclosure: Nothing to disclose

EPR3115

Muscle MRI fat fractions correlate with function in Becker muscular dystrophy independent of the unequal proximo-distal fat distribution

N. Van de Velde¹, M.T. Hooijmans²,
Z. Koeks-Braakman¹, T.T. Veeger², A. Sardjoe-Mishre²,
J.J. Verschuuren¹, H.E. Kan², E.H. Niks¹
¹Neurology, LUMC, Leiden, Netherlands, ²Radiology,
LUMC, Leiden, Netherlands

Background and aims: Phenotype variability and slow disease progression in Becker muscular dystrophy (BMD) complicate clinical trial design. Muscle fat fraction (FF) assessed by quantitative MRI is a promising biomarker. We studied the relation between muscle fat replacement and function in BMD.

Methods: 3-point Dixon 3T MRI thigh scan data (23 slices of 1cm, 0.5cm gap) of 24 BMD patients (median age 41.3 years, range 18.8-66.3) were correlated to function. Weighted average FFs (wFF) of the vastus lateralis (VL) and semitendinosus were determined over 2 areas: 3 center slices (3S) landmarked on the biceps femoris short head insertion, and the whole muscle (WM). Statistics with Wilcoxon's Signed-Rank-Test and Spearman's correlation.

Results: Upon visual inspection, VL FF distribution followed an U-shaped curve, while in semitendinosus FF was low near the origo and higher near the insertion (figure 1). wFF of 3S was lower than WM in VL ($50.1 \pm 28.5\%$ and $57.5 \pm 28.8\%$, $p=0.001$), while it was higher in semitendinosus ($57.0 \pm 35.2\%$ in 3S versus $42.0 \pm 30.0\%$ in WM, $p=0.005$). wFF correlations for both the 6-Minute Walk Test and the North Star Ambulatory Assessment were similar for 3S and WM in VL ($\rho=-0.786$ vs $\rho=-0.797$ and $\rho=-0.880$ vs $\rho=-0.887$) and semitendinosus ($\rho=-0.875$ vs $\rho=-0.860$ and $\rho=-0.908$ vs $\rho=-0.924$), see table 1.

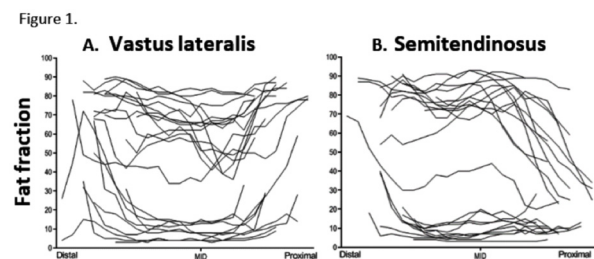

Figure 1. Distribution of FF along the proximodistal axis in Vastus lateralis and Semitendinosus. Mid represents the middle of the thigh based on the biceps femoris short head insertion.

Table 1.

	Vastus lateralis		Semitendinosus	
	3 slices wFF	whole muscle wFF	3 slices wFF	whole muscle wFF
6-Minute Walk Test, rho	-0.786	-0.797	-0.875	-0.908
North Star Ambulatory Assessment, rho	-0.880	-0.887	-0.860	-0.924

Table 1. Correlations between Vastus lateralis and Semitendinosus wFF and function tests

Conclusion: FF correlated highly with function in BMD, congruent with findings in other muscular dystrophies, and were not influenced by non-uniform fat replacement. This indicates that muscle MRI may serve as biomarker in BMD trials. Stringent control of year-to-year slice positioning is essential as average 3S versus WM wFF differed significantly.

Neurogenetics 2

EPR3116

Exome sequencing results for early onset Parkinson’s disease cases from Kazakhstan

R. Kaiyrzhanov¹, N. Zharkinbekova¹, C. Shashkin¹, V. Akhmetzhanov¹, A. Aitkulova², J. Vandrovцова³

¹ Department of Neurology, South Kazakhstan Medical Academy, Shymkent, Kazakhstan, ²Department of molecular genetics, National Center for Biotechnology, Nur-Sultan, Kazakhstan, ³UCL Institute of Neurology, London, United Kingdom

Background and aims: A number of genes and chromosomal loci for Parkinson’s disease (PD) have been identified for the last decades. The genetic determinants of PD are largely unknown in Central Asia, including Kazakhstan. Here we have genotyped early-onset PD (EOPD) probands from Kazakhstan by exome sequencing. EOPD was defined as the onset before the age of 50 years old (1).

Methods: Genomic deoxyribonucleic acids (DNAs) of 48 EOPD index cases were obtained from the research-ready database of PD cases from Kazakhstan. Whole exome sequencing (WES) was performed at the Institute of Neurology University College London. Variants from WES were filtered such that only novel (or very low frequency <0.1%), coding/splicing, heterozygous, homozygous or compound heterozygous variants in known PD genes that are predicted to be deleterious and damaging or pathogenic were considered as likely causal.

Results: The mean age at PD onset in the cohort was 38.1±7.5 years (range 14-50), mean age of patients was 46.4±7.7, and mean disease duration was 8.3±4.7 (Table 1). The cohort was made of 36 Kazakhs, 11 Russians, and 1 Korean. Only 17 cases were found to be positive for known PD genes (Table 2). 12 cases had variants in LRRK2, and the rest 5 cases had variants in DNAJC13, EIF4G1, UCHL1, VPS13C, and VPS35 genes.

Table 1 Demographic and clinical characteristics of the cohort

Demographic and clinical characteristics	Values
Mean age at onset ± SD(years), (range)	38.1±7.5 (14-50)
Mean age at the last examination ± SD(years), (range)	46.4±7.7 (28-66)
Mean disease duration ± SD(years), (range)	8.3±4.7 (0-24)
Male to female ratio (males:females)	1:0.8 (26M:22F)
Family history, n (%)	10 (21)
Mean Hoehn-Yahr stage	2.4±0.6
Mean motor MDS UPDRS score	40.1 ± 18.3

Table 1

Conclusion: Mostly LRRK2 pathogenic and novel variants were associated with Kazakhstani EOPD cases. WES negative cases warrant further TRIO exome and genome sequencing studies. These studies might reveal candidate genes specific to Kazakhstani PD population.

Disclosure: This research was funded by the Medical research council (MRC) [MR/S01165X/1, MR/S005021/1, G0601943].

Table 2 Positive findings

Gene	Variant	N of cases	allele frequency	Pathogenicity	SB and Pathogenic probabilities	Clinic	FX	EM	EMO	Ethnic group
LRRK2	NM_130358.4 c.12246C>T p.A4016V	8	0.0000	Deleterious Probably damaging	Deleterious Probably damaging	Familial Start Mid-late life 35, 39, 42	8/8	3/3	42.6 1.4	Russian 1 Kazakh 7
LRRK2	NM_130358.4 c.40935A>G p.R1364G	1	0.0000	Deleterious Probably damaging	Deleterious Probably damaging	Not reported	ns	ns	ns	Kazakh
LRRK2	NM_130358.4 c.38137C>T p.Y12713Y	1	Not reported	Deleterious Probably damaging	Deleterious Probably damaging	Not reported	ns	ns	ns	Kazakh
LRRK2	NM_130358.4 c.41232C>A p.R13744I	7	0.0000	Deleterious Probably damaging	Deleterious Probably damaging	Familial Start Mid-late life 38, 39, 40	7/7	3/3	42.6 1.4	Russian 2 Kazakh 5
DNAJC13	NM_012028.4 c.42131C>A p.R14043Y	1	0.0000	Deleterious Probably damaging	Deleterious Probably damaging	Not reported	ns	ns	ns	Kazakh
EIF4G1	NM_001159462.2 c.10818C>T p.A36151V	1	0.0000	Deleterious Probably damaging	Deleterious Probably damaging	Not reported	ns	ns	ns	Kazakh
UCHL1	NM_004243.3 c.1212G>A p.S404N	1	0.0000	Loss of function	Loss of function	Not reported	ns	ns	ns	Kazakh
VPS13C	NM_001048153.1 c.7988A>C p.R2662H	1	0.0000	Deleterious Probably damaging	Deleterious Probably damaging	Not reported	ns	ns	ns	Kazakh
VPS13C	NM_001048153.1 c.28191A>G p.R9400Y	1	0.0000	Deleterious Probably damaging	Deleterious Probably damaging	Not reported	ns	ns	ns	Kazakh
VPS35	NM_015026.6 c.714C>G p.R238W	1	Not reported	Not reported	Not reported	Not reported	ns	ns	ns	Russian

Table 2

EPR3117

Defects in the myogenesis-regulating glycosidase (MYORG) gene in a family with primary brain calcification presenting with stroke-like episodes

M.J. Malaquias¹, R. Martins², J. Oliveira³, J. Freixo³, M. Magalhães¹

¹Neurology, Centro Hospitalar Universitário do Porto, Porto, Portugal, ²Neuroradiology, Centro Hospitalar Universitário do Porto, Porto, Portugal, ³Center for Predictive and Preventive Genetics (CGPP), Institute for Molecular and Cell Biology (IBMC), Instituto de Investigação e Inovação em Saúde (i3S), Universidade do Porto, Porto, Portugal, Porto, Portugal

Background and aims: Primary familial brain calcification (PFBC), a traditionally autosomal dominant (AD) disorder, was recently expanded to include an autosomal recessive inheritance associated with defects in the MYORG gene. Until now, only 23 families with MYORG-related PFBC have been reported in the literature.

Methods: Retrospective analyze and MYORG screening of a portuguese family with PFBC.

Results: A 51-year-old female patient with a history of depression, presented with acute onset right hemiparesis. On examination, she had mild cognitive impairment, dysarthria, brisk tendon reflexes, spastic right hemiparesis, slightly symmetrical parkinsonism and dysmetria on finger-nose testing. Brain CT scan revealed symmetric calcifications in basal ganglia and dentate nucleus with cerebellum atrophy. Over the years, the disease followed a progressive course with acute stroke-like episodes. She became wheelchair-bound at the age of 55 years and died at 71 years of age. She had 2 siblings, both sharing a similar phenotype. Genetic testing with a gene panel for AD-PFDC based on whole exome sequencing (WES) was not conclusive. Further reanalysis of WES data for the recently identified MYORG gene, allowed the identification of two likely pathogenic frameshift variants in compound heterozygous state (NM_020702.4:c[285_310delinsTTC];[535_536insC]).

From the 7 children of the affected cases (all obligate heterozygous carriers), 3 were clinically evaluated. All had brisk reflexes but none presented calcifications on brain CT scan.

Conclusion: A detailed description of stroke-like episodes in PFBC patients is provided. The accumulation of knowledge about the phenotype of MYORG-related PFBC will be useful for early diagnosis and to attain further phenotype-genotype correlations in this clinical entity.

Disclosure: Nothing to disclose

EPR3118

A rare p.R342W TGM6 (SCA35) mutation in a patient with late-onset cerebellar ataxia

A. Manini¹, T. Bocci², E. Monfrini³, D. Ronchi³, M. Vizziello⁴, G. Franco³, F. Arienti³, A. De Rosa⁵, F. Sartucci⁶, A. Di Fonzo³

¹Department of Biomedical and Clinical Sciences Luigi Sacco, University of Milan, Milan, Italy., ²"Aldo Ravelli" Center for Neurotechnology and Experimental Brain Therapeutics, Department of Health Sciences, University of Milan and ASST Santi Paolo e Carlo, Milan, Italy., ³Foundation IRCCS Ca' Granda Ospedale Maggiore Policlinico, Neurology Unit, Milan, Italy; Dino Ferrari Center, Neuroscience Section, Department of Pathophysiology and Transplantation, University of Milan, Milan, Italy, Milan, Italy, ⁴Fondazione IRCCS Ca' Granda Ospedale Maggiore Policlinico, Milan, Italy, ⁵Unit of Neurology, Pisa University Medical School, Pisa, Italy, ⁶Department of Clinical and Experimental Medicine, Section of Neurophysiopathology, Pisa University Medical School, Pisa, Italy

Background and aims: Mutations in TGM6 have been recently implicated in the pathogenesis of spinocerebellar ataxia type 35 (SCA35), a rare autosomal dominant disease, marked by cerebellar degeneration. The associated phenotype includes slow progressive postural instability and incoordination of gait, cerebellar dysarthria, dysmetria, saccadic slowing and pyramidal signs. TGM6, a member of the transglutaminase superfamily specifically expressed in the central nervous system, is involved in proteins cross-linking. Even though it is established that mutations of TGM6 described so far reduce transglutaminase activity, the precise molecular pattern impaired is still unclear. The aim of our study was to report a rare heterozygous missense mutation of TGM6 in a patient with late-onset cerebellar ataxia.

Methods: We performed a neurological evaluation and genetic analysis by whole exome sequencing of a patient with late-onset, progressive cerebellar ataxia and pyramidal tract signs. The identified variant was subsequently confirmed at Sanger sequencing.

Results: A novel TGM6 heterozygous mutation (p.R342W) was detected in a patient with late-onset, progressive cerebellar ataxia, pyramidal tract signs, cerebellar dysarthria and ocular dysmetria. A cerebellar atrophy was confirmed by brain imaging. The mutation, located at a highly conserved position, was rare (MAF 0.02%) and predicted as pathogenic by in-silico tools.

Conclusion: In summary, we described the clinical phenotype of an Italian SCA35 patient, who was confirmed to have a rare heterozygous missense mutation of TGM6. This is the 1st description of an Italian case of SCA35. Despite its rare frequency among general population, we suggest considering SCA35 genetic testing in case of undiagnosed cerebellar ataxia.

Disclosure: This work was supported by ADF's funds, from Intesa San Paolo and Fresco Institute.

EPR3120

Mitochondrial trifunctional protein deficiency (MTP-defect) - a metabolic cause of hereditary neuromuscular disorder with a mild course

K. Orstavik¹, K.A. Arntzen², E. Kristensen³, M. Rasmussen⁴, M. Van Ghelue⁵, M. Nebuchennykh², C. Jonsrud⁵, Y.T. Blikrud⁵

¹Department of Neurology, section for rare Neuromuscular disorders, Oslo University Hospital, Oslo, Norway,

²Department of Neurology, University Hospital North Norway, Tromsø, Norway, ³Department of Medical Biochemistry, Oslo University Hospital, Oslo, Norway,

⁴Department of Clinical Neurosciences for Children, Oslo University Hospital, Norway, ⁵Department of Medical Genetics, Division of Child and Adolescent Health,

University Hospital of North Norway, Tromsø, Norway

Background and aims: MTP-defect is a rare recessive fatty oxidation disorder that might cause several phenotypes including encephalopathy, cardiomyopathy and liver failure. Benign phenotypes including polyneuropathy and recurrent rhabdomyolysis have also been described. We describe three patients with mild symptoms.

Methods: Methods were used as described in results.

Results: Patient 1 was a female around 30-year-old with normal development until 6 years of age when she suffered from decreased energy and was gaining weight. At 9 years old she developed subacute generalized muscular weakness after an infection. Repeated clinical neurophysiology confirmed an axonal neuropathy. Since then she has experienced weekly episodes of weakness lasting several hours. CK and lactic acid have always been normal. An increased concentration of the long hydroxyacylcarnitines was found. Patient 2 and 3 are sisters around 20. They both experienced episodes of weakness after physical activity and more pronounced during infections. Clinical findings were compatible with neuropathy, and neurophysiology confirmed axonal involvement. Muscle biopsy revealed neuropathic changes. After genetic testing, patient 1 was shown to be compound heterozygous for 2 variants of unknown significance (VUS) in the HADHB-gene. The 2 sisters were homozygous for another VUS in HADHB. Low activity of long chain 3-hydroxyacyl-CoA dehydrogenase (LCHAD) and 3-ketotiolases (Long-chain) confirmed a defect in the MTP metabolism in all patients.

Conclusion: MTP-defects might give rise to mild symptoms mainly causing an axonal neurogenic disorder. However, a correct diagnosis is important since these patients should be instructed in eating a diet low in fat, and they need an SOS-regime during acute illness.

Disclosure: Nothing to disclose

EPR3121

Early structural alterations and longitudinal changes in presymptomatic carriers of the C9orf72 expansion

D. Saracino¹, A. Guyot², M. Houot³, S. Sayah⁴, A. Funkiewiez⁴, D. Rinaldi⁵, A. Routier², F. Pasquier⁶, D. Wallon⁷, P. Couratier⁸, O. Colliot², I. Le Ber¹
¹Institut du Cerveau et de la Moelle Epinière, AP-HP - Hôpital Pitié-Salpêtrière, Sorbonne Université, Paris, France, ²Aramis Project Team, Inria Research Center, Institut du Cerveau et la Moelle épinière (ICM), AP-HP - Hôpital Pitié-Salpêtrière, Paris, France, ³Centre of Excellence of Neurodegenerative Disease (CoEN), ICM, CIC Neurosciences, Département de Neurologie, AP-HP - Hôpital Pitié-Salpêtrière, Paris, France, ⁴Reference Centre for Rare or Early Dementias, IM2A, Département de Neurologie, Institut du Cerveau et la Moelle épinière (ICM), AP-HP - Hôpital Pitié-Salpêtrière, Paris, France, ⁵Institut du Cerveau et de la Moelle Epinière, AP-HP - Hôpital Pitié-Salpêtrière, Paris, France, ⁶Inserm U1171, DistAlz, LiCEND, CNR-MAJ, CHU Lille, Lille, France, ⁷Department of Neurology, Rouen University Hospital, Rouen, France, ⁸CMRR Service de Neurologie, CHU de Limoges, Limoges, France

Background and aims: The C9orf72 repeat expansion is the main genetic cause of frontotemporal lobar degeneration (FTLD) and amyotrophic lateral sclerosis (ALS). Promising therapeutic trials, such as antisense oligonucleotides, are upcoming, and presymptomatic carriers represent the optimal target population. We aimed to assess the earliest MRI alterations and their longitudinal modifications as markers to monitor disease evolution in the presymptomatic stage.

Methods: PrevDemALS is a multicentric, prospective, observational study focused on 1st-degree relatives of C9orf72-associated FTLD/ALS patients. Clinical, cognitive and brain MRI assessments are performed at baseline and every 18 months. 81 participants underwent the 1st 2 evaluations. FreeSurfer cross-sectional and longitudinal pipelines were run through Clinica platform (www.clinica.run) to process T1-weighted sequences. Cortico-subcortical ROIs were defined with Desikan-Killiany and aseg atlases. Baseline ROI volumes and their longitudinal changes were compared between C9orf72 carriers (C9+) and non-carriers (C9-) using generalized linear mixed-effects models.

Results: C9+ (n=42) and C9- (n=39) individuals were comparable for age at inclusion (42.6±11.8 vs 46.1±13.5, p=0.22), well below the average age at onset. Several cortical ROIs in both hemispheres were significantly more atrophic at baseline in C9+, including precentral, orbitofrontal, inferior temporal, fusiform cortex, and precuneus. Both thalami were among the most involved regions. No significant longitudinal progression of atrophy could be detected after 18 months.

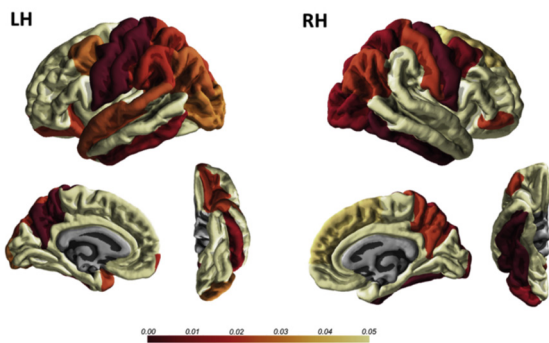

Figure 1. Baseline regional cortical atrophy in C9+ compared to C9-. Several cortical ROIs displayed significant atrophy in presymptomatic carriers. No significant longitudinal progression was detected (data not shown). P-values are corrected for multiple comparisons with Benjamini-Hochberg method. LH: left hemisphere; RH right hemisphere.

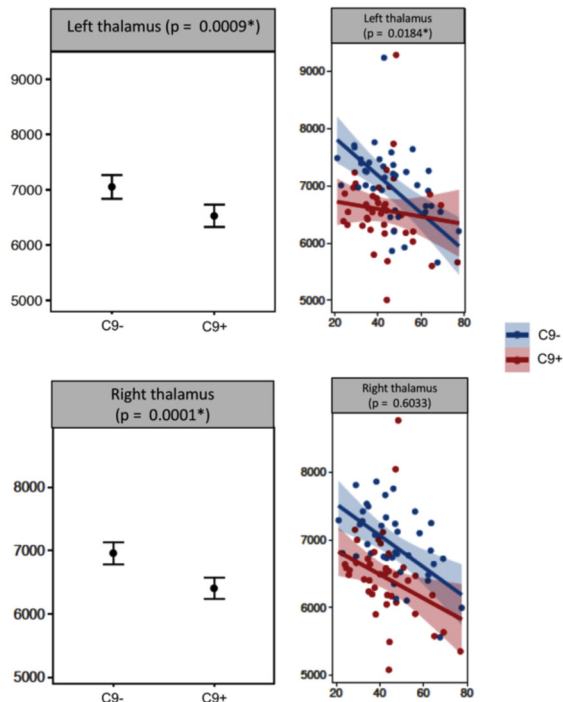

Figure 2. Thalamic volumes in C9+ and C9-. Presymptomatic carriers showed significantly reduced volumes in both thalami at baseline. Thalamic volumes did not show greater decline in the more aged C9+ compared to C9- subjects. Volumes are expressed as mm³. P-values are corrected for multiple comparisons with Benjamini-Hochberg method.

Conclusion: Cortical and subcortical atrophy is detectable several years before clinical onset in C9orf72 disease, but shows little progression over time. Longer follow-up periods and additional neuroimaging techniques will likely help detect slowly progressive alterations in the presymptomatic phase.

Disclosure: Nothing to disclose

EPR3122

Phenotypic expansion of ATP13A2 related disorders

A. Sardoeira¹, E. Brandão², M. Rocha³, S. Pina⁴, S. Cavaco⁵, I. Alonso⁶, J. Barros¹, J. Sequeiros⁶, H. Costa³, J. Leal Loureiro², J. Damásio¹

¹Neurology, Centro Hospitalar Universitário do Porto, Porto, Portugal, ²Neurology, Centro Hospitalar de Entre o Douro e Vouga, Santa Maria da Feira, Portugal, ³Neurology, Centro Hospitalar Vila Nova de Gaia/Espinho, Vila Nova de Gaia, Portugal, ⁴Neuroradiology, Centro Hospitalar Universitário do Porto, Porto, Portugal, ⁵Neuropsychology Unit, Centro Hospitalar Universitário do Porto, Porto, Portugal, ⁶Institute for Molecular and Cell Biology, University of Porto, Porto, Portugal

Background and aims: Pathogenic variants in ATP13A2 gene were 1st described in 2006 as causing Kufor-Rakeb syndrome. Since then the phenotype has been expanded to include developmental delay, epilepsy, dystonia, spastic paraplegia (SPG78), ataxia and peripheral neuropathy. We aim to describe a family with developmental delay who developed spastic paraplegia only in adulthood.

Methods: Descriptive analysis of clinical, imaging, electrophysiological, neuropsychological and genetic findings.

Results: We identified 4 patients in a 9-sibling consanguineous kindred. All had psychomotor delay, with marked intellectual disability and learning difficulties. Gait impairment onset ranged from 20-31 years. Before the age of 40 years all had spastic paraplegia, with additional dystonic signs in 2 and ataxia in 1 patient. MRI disclosed generalized cortical atrophy in all, white matter lesions in 3 and cerebellar atrophy in 2. Electromyography was performed in 2, with normal results. Neuropsychological evaluation of 3 patients revealed multidomain deficits, consistent with abnormal cognitive development. On genetic testing a homozygous missense variant in ATP13A2 (c.1510G>C(p.(Gly504Arg)) was identified.

Conclusion: In this family the dominant phenotype was developmental delay without any additional neurological signs until adulthood. Later in life, all affected siblings developed spastic paraplegia, some including additional dystonia and ataxia, with a mutation previously reported in a patient with juvenile parkinsonism. Besides describing an alternative phenotype for this same mutation, we wish to draw attention into testing for ATP13A2 pathogenic variants in children with “pure” developmental delay.

Disclosure: Nothing to disclose

EPR3123

Frequency of GGGGCC-expansion in C9orf72 gene in Russian cohort of patients with ALS and FTD

Y. Shpilyukova¹, E. Fedotova¹, N. Abramycheva¹, I. Kochergin¹, M. Zakharova¹, D. Grishina², S. Illarioshkin¹

¹Research Center of Neurology, Moscow, Russian Federation, ²I.M. Sechenov First Moscow State medical University, Moscow, Russian Federation

Background and aims: Hexanucleotide repeats expansion in C9orf72 gene is the most frequent genetic cause of amyotrophic lateral sclerosis (ALS) and frontotemporal dementia (FTD) in different populations, especially in the combined ALS-FTD phenotype. Our previous work showed that the C9orf72 repeat expansion may occur in Russian patients with ALS. However, the exact frequency of this mutation in ALS and FTD patients in Russian population has never been estimated before.

Methods: We analyzed DNA samples of patients with ALS (n=419), FTD (n=79) and ALS-FTD (n=16). All patients were examined and diagnosed in Research Center of Neurology and I.M. Sechenov First Moscow State medical University (Moscow). The C9orf72 expansion (>50 GGGGCC-repeats) was identified by repeat primed PCR.

Results: The frequency of the C9orf72 repeat expansion in ALS group was 4.3%, including 9% in familial ALS and 4% in sporadic cases. The frequency of this expansion in FTD group was 3.6%, including 3.3% in familial FTD and 4% in sporadic cases. The frequency of the C9orf72 repeat expansion in ALS-FTD group was 38%.

Conclusion: We present the 1st data on the prevalence of C9orf72 expansion in the large group of FTD patients from Russian population. The frequency of this mutation in ALS according to our updated results is higher than the previous estimates, especially in familial cases. In addition, we revealed the high prevalence of C9orf72 gene repeat expansion in ALS-FTD patients that is comparable with data in other populations.

Disclosure: The study was supported by RFBR 19-015-00533

EPR3124

Design of a risk assessment model for Parkinson's disease

C. Strafella¹, V. Caputo², A. Termine³, G. Spalletta³, E. Giardina¹, R. Cascella¹

¹Santa Lucia Foundation; Tor Vergata University, Rome, Italy, ²Tor Vergata University, Rome, Italy, ³Santa Lucia Foundation, Rome, Italy

Background and aims: The availability of high-throughput technology and computational facilities enabled a deeper investigation of neurogenetic disorders, paving the way for the development of precision medicine approaches. This study aimed to elucidate the network of genes characterizing Parkinson disease (PD) and identify a set of predictive biomarkers specific for PD.

Methods: 259 patients with idiopathic PD were recruited at the IRCCS Santa Lucia. Genomic DNA was subjected to genotyping analysis by Open Array platform, consisting of the analysis of 120 Single Nucleotide Polymorphisms (SNPs). The obtained results were processed by statistical (Information Theory and Logistic Regression) and bioinformatic (GSEA, IPA, String, Phenolyzer) tools in order to assess the significant association with disease and select a set of SNPs as predictive biomarkers for PD.

Results: The statistical analysis identified 7 SNPs as candidate predictors for PD risk (Table 1). The logistic regression showed that 4 of these SNPs were significantly associated with PD and thereby were utilized to generate a classifier able to discriminate cases and control subjects. This model showed to be accurate, sensitive and specific (AUC:0.95; sensitivity:0.72; specificity:0.88). Concerning bioinformatic analysis, the associated SNPs resulted to be involved in dopamine metabolism, immune-inflammatory processes and endocytosis.

Gene	Informative SNP	p-value
<i>MAOA</i>	rs1137070	0.06
<i>MAOA</i>	rs2072743	0.007
<i>VSIG4</i>	rs1044165	0.0004
<i>MAOB</i>	rs1799836	0.0005
<i>PTGS2</i>	rs20417	0.98
<i>miR-4482</i>	rs45596840	0.07
<i>CLOCK</i>	rs6811520	0.0008

Table 1. Statistical results showing candidate SNPs predictors and the associated SNPs obtained by logistic regression. The cut-off for significant p-value was set at p<0.05. In bold characters are reported the SNPs significantly associated with PD.

Conclusion: This study allowed to set-up an accurate model for assessing the risk of PD based on the patient's genetic profile. Moreover, the bioinformatic analysis highlighted the existence of a network of genes that could elucidate new disease mechanisms and reveal novel therapeutic targets that could be exploited for developing precision medicine protocols for PD treatment.

Disclosure: Nothing to disclose

Neuro-oncology 2

EPR3125

Disparities in Patient Enrollment on Glioblastoma Clinical TrialsN. Mohile¹, Y. Liu², A. Wasilewski¹¹Neurology, University of Rochester, Rochester, USA,²Neurosurgery, University of Rochester, Rochester, USA

Background and aims: To determine if enrollment on glioblastoma (GBM) interventional clinical trials (ICT) in the U.S. is representative of the population, to identify disparities and describe their evolution over time.

Methods: We queried ClinicalTrials.gov for all adult ICT in GBM from 1994 to 2019. Intervention type was assigned based on definitions in the National Cancer Institute (NCI) drug dictionary. Demographics were obtained from ClinicalTrials.gov or the trial publication and compared to corresponding population data from the Central Brain Tumor Registry of the United States (CBTRUS).

Results: 10617 GBM patients enrolled on 118 adult ICT: experimental agents in 99 ICT were systemic therapy (cytotoxic (24), immunotherapy/vaccine (11) and targeted therapy (64)); 19 ICT involved other modalities. Median age was 54.0 (10.05 years younger than CBTRUS, $p < 0.001$). Age was most discrepant in recurrent vs newly diagnosed (11.29 years younger vs. 7.57, $p < 0.001$), non-randomized vs randomized, (10.54 years younger vs 7.65, $p = 0.004$) and NCI consortium vs. other (10.61 years younger vs. 7.83, $p = 0.005$). Median age improved from 52.0 (1994-2002) to 59.5 (2011-2019). Women represented only 37.5% of subjects, 1.23% less than expected from population data ($p < 0.018$). Data on race was unavailable for most trials from any source.

Conclusion: Despite improvement over time, GBM ICTs underrepresent older patients. Fewer women enroll on GBM ICT than men. Reporting of race and ethnicity should be encouraged. ICTs need to be designed and implemented to better represent the population.

Disclosure: Nothing to disclose

EPR3126

Does the location matter?**Characterization of the anatomic locations, molecular profiles, and clinical features of gliomas**C. Mackintosh¹, R. Butterfield², N. Zhang³, J. Lorence⁴,P. Zlomanczuk⁵, B. Bendok⁶, R. Zimmerman⁶,K. Swanson⁷, A. Porter⁸, M. Mrugala⁸¹School of Medicine, Mayo Clinic, Scottsdale, USA,²Department of Biostatistics, Mayo Clinic, Scottsdale, USA,³Mayo, Scottsdale, USA, ⁴Mathematical Neuro-oncologyLab, Mayo Clinic, Scottsdale, USA, ⁵Department of

Physiology, Nicolas Copernicus University, Bydgoszcz,

Poland, ⁶Department of Neurosurgery, Mayo Clinic,Scottsdale, USA, ⁷Mathematical Neuro-oncology Lab, MayoClinic, Scottsdale, USA, ⁸Department of Neurology, Mayo

Clinic, Scottsdale, USA

Background and aims: Neuroanatomic locations of gliomas may influence clinical presentations, molecular profiles, and patients' prognoses.

Methods: Our institutional cancer registry was queried to include patients with glioma over a 10-year period. Statistical analyses were used to compare demographic, genetic, and clinical characteristics among patients with gliomas in different locations.

Results: 182 gliomas were identified. Of the tumors confined to a single lobe, there were 51 frontal (28.0%), 50 temporal (27.5%), 22 parietal (12.1%), and 7 occipital tumors (3.8%) identified. Tumors affecting temporal lobe were associated with reduced overall survival when compared to all other tumors (11.0 months vs. 13.0 months, log-rank $p = 0.0068$). However, this disparity became insignificant when adjusted for tumor grade, age, and surgical approach [HR(95% CI) 1.26 (0.87, 1.82), $p = 0.212$]. Out of 82 cases tested for IDH-1, 10 were mutated (5.5%). IDH-1 mutation was present in 6 frontal, 2 temporal, 1 thalamic, and 1 multifocal tumor. Out of 21 cases tested for 1p19q deletions, 12 were co-deleted, 9 of which were frontal lobe tumors. MGMT methylation was assessed in 45 cases; 7 of 14 frontal tumors and 6 of 13 temporal tumors were methylated.

Conclusion: Results support the hypothesis that the anatomical locations of gliomas influence patients' clinical courses. Temporal lobe tumors were associated with poorer survival, though this association appeared to be driven by these patients' more aggressive tumor profiles and higher risk baseline demographics. Molecular analysis was limited by low prevalence of genetic testing in the study sample, highlighting the importance of capturing this information for all gliomas.

Disclosure: Nothing to disclose

EPR3127

ABTR-SANO Real-World Pattern of Care Study on Glioblastoma in the Austrian Population.

S. Oberndorfer¹, A. Woehrer², C. Marosi³,
 T. Urbanic-Purkart⁴, M. Nowosielski⁵, S. Iglseider⁵,
 G. Stockhammer⁵, W. Kleindienst⁶, C. Floria⁷, A. Hager⁸,
 A. Tinchon⁹, M. Stultschnig¹⁰, B. Surböck¹¹, J. Pichler¹²,
 S. Weiss¹³, M. Hutterer¹⁴, L. Seebrecht¹⁵, T. Rötzer¹⁵,
 A. Hainfellner¹⁵, J. Hainfellner¹⁶,
 A. Brain Tumor Consortium¹⁷

¹Department of Neurology, Landeskrankenhaus St. Pölten, St. Pölten, Austria, ²Department of Neurology, Division of Neuropathology and Neurochemistry, , Medical University of Vienna, Vienna, Austria, ³Oncology, Vienna General Hospital, Vienna, Austria, ⁴Neurology, Medical University of Graz, Graz, Austria, ⁵Neurology, Medical University Innsbruck, Innsbruck, Austria, ⁶Neurology, Christian Doppler Medical Center, Paracelsus Medical University, Salzburg, Austria, ⁷Neurology, Christian Doppler Klinik, Salzburg, Salzburg, Austria, ⁸Neurology, Landesklinikum Wr Neustadt, Wr Neustadt, Austria, ⁹Neurology, University Clinic St Pölten, KLP, St Pölten, Austria, ¹⁰Neurology, Klinikum Klagenfurt, Klagenfurt, Austria, ¹¹Neurology, SMZ-Ost, Vienna, Austria, ¹²Department Internal Medicine, J Kepler University Clinic, Linz, Austria, ¹³Pathology, J Kepler University Clinic, Linz, Austria, ¹⁴Neurology ¹, Neuromed Campus Kepleruniversitätsklinikum Linz, Linz, Austria, ¹⁵Medical University of Vienna, ²Department of Neurology, Division of Neuropathology and Neurochemistry, Vienna, Austria, ¹⁶Neurology, Medical University of Vienna, Vienna, Austria, ¹⁷Medical University Vienna, ABTR-SANOnet, Vienna, Austria

Background and aims: The Austrian ABTR-SANO Glioblastoma Registry is the 1st population-based assessment of patterns of care for patients with Glioblastoma across Austrian healthcare institutions. The primary aim is to assess the real world effectiveness of administered therapies. Additionally, characteristics with respect to diagnostics and safety profiles of interventions can be provided on the basis of a surveillance/non-interventional study.

Methods: Clinical data are collected via a common web-based IT platform “ABTR-SANO Net” since 2014. The database and the ongoing evaluation of clinical parameters, as well as interim analysis are provided in cooperation with a review board.

Results: Meanwhile 11 centers across Austria are involved, which collect the information of now over 1500 patients (m/f ratio: 1,3 - median age: 66 years). The proportion of patients with gross total resection increased gradually since 2014 from 36% to 56% in 2019. Almost all patients were MGMT tested in 2019, whereas in 2014 only half of patients underwent MGMT testing. Analysis of median time from clinical presentation to diagnostic scan (overall: 9 days), time from diagnostic scan to surgery (overall: 10 days), and time from surgery to the beginning of first line treatment (overall: 31 days) was stable. First overall survival data show a median survival of 12 months.

Conclusion: 1 defined set of clinical parameters results in phenotypic annotation of the patient cohort from 2014 ongoing. Pattern of care characteristics show a different picture with respect to treatment, as we used to see in RCT. Outcome analysis comparing different Austrian centers will be available in 2020.

Disclosure: Nothing to disclose

EPR3128

Neurological adverse events during immune-checkpoint inhibitors treatment: a report from the Italian Neurological Society (SIN) database.

A. Picca¹, L. Diamanti¹, G. Berzero¹, P. Bini¹, M. Gastaldi¹, E. Rota², R. Rudà³, F. Bruno³, V. Villani⁴, A. Vogrig⁵, M. Zoccarato⁶, E. Marchioni¹
¹Neuro-Oncology Unit, IRCCS C. Mondino Foundation, Pavia, Italy, ²Neurology Department, ASL Alessandria, Alessandria, Italy, ³Division of Neuro-Oncology, Department of Neuroscience, University and City of Health and Science Hospital of Turin, Turin, Italy, ⁴Department of Clinical Experimental Oncology, Regina Elena National Cancer Institute, Rome, Italy, ⁵Udine, Italy, ⁶Neurology, Sant'Antonio Hospital, Padua, Italy

Background and aims: Immune-related adverse events (irAEs) due to immune-checkpoint inhibitors (ICI) treatment are increasingly recognized. Although rare, neurological irAEs may be severe and often difficult to diagnose. Their prompt recognition is crucial, as they may be reversed with proper treatment. To better define the clinical spectrum of ICI-related neurological toxicities the Neuro-oncology Study Group of the Italian Neurological Society promoted the creation of a national database.

Methods: A national, web-based database was created. All physicians who manage oncological patients were allowed to spontaneously include cases.

Results: From 01/01/2019 to 15/01/2020, 19 patients (16 males, 3 females; median age 71 years) have been entered in the database. Underlying malignancy and type of ICI treatment are reported in Table1. The median number of ICI cycles at irAE onset was 3 (range 1-22). 15 patients developed a peripheral nervous system (PNS) toxicity, while four had a central involvement (Figure1). All but 1 required treatment (n=14: corticosteroids, n=3: IVIg, n=1: corticosteroids+IVIg), with a complete response in 3, partial in 10. 5 required a 2nd-line treatment. Toxicity was severe (CTCAE_≥3) in 17/19, with three fatalities (Figure2). 3 patients resumed ICI, without neurological relapses.

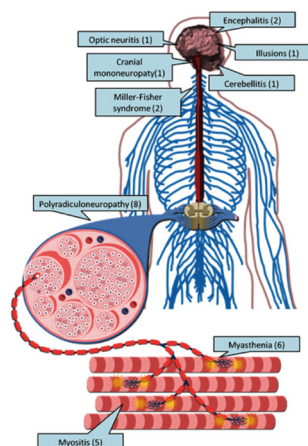

Figure 1. Neurological toxicities during immune-checkpoint inhibitors treatment (19 reported patients, multiple involvement in 7).

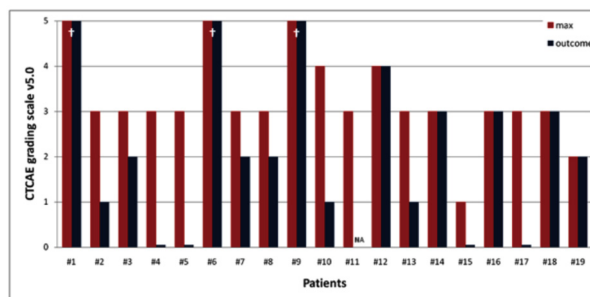

Figure 2. Max toxicity and outcome according to CTCAEv5.0 grading scale. NA = not available. † = deceased.

Conclusion: Neurological irAEs affected most frequently the PNS, and a multiple involvement (“overlap” syndromes) appeared common. Although they frequently improved with immunomodulating treatments (as corticosteroids), irAE progression to death have been reported. In a subset of less severe cases, however, ICI resumption appeared feasible with no neurological irAE relapses. Further inclusions will possibly help us to identify predictors of outcome and response to treatments.

Disclosure: Nothing to disclose

Table 1.	
Malignancy (number of patients)	Melanoma (6) Non-small cell lung cancer (5) Urothelial carcinoma (3) Renal-cell carcinoma (2) Other (3)
Type of immune-checkpoint inhibitor (number of patients)	Anti-PD1 (12) Nivolumab (7) Pembrolizumab (5) Anti-PDL1 (3) Atezolizumab (3) Anti-CTLA4 (1) Ipilimumab (1) Combination therapies (3) Ipilimumab + Nivolumab (3)

Table 1. Malignancy and type of immune-checkpoint inhibitor treatment in reported patients (n=19).

EPR3129

Clinical, molecular and radiomic profile of gliomas with FGFR3-TACC3 fusions

A. Picca¹, A.L. Di Stefano², E. Saragoussi³, F. Bielle⁴, F. Ducray⁵, V. Bourg⁶, L. Bellu¹, M. Eoli⁷, C. Villa², A. Gloaguen⁸, C. Philippe⁹, V. Frouin⁹, Y. Schmitt¹, J. Lerond¹, J. Leclerc⁴, A. Lasorella¹⁰, A. Iavarone¹¹, K. Mokhtari⁴, J. Savatovsky³, A. Alentorn¹², M. Sanson¹
¹Inserm U1127, Institut du Cerveau et de la Moelle épinière, Paris, France, ²Hopital Foch, Suresnes, France, ³Radiology Department, Fondation Ophthalmologique Adolphe de Rothschild, Paris, France, ⁴Neuropathology, AP-HP, Hôpitaux Universitaires Pitié Salpêtrière-Charles Foix, Paris, France, ⁵Lyons, France, ⁶Nice, France, ⁷Fondazione I.R.C.C.S Istituto Neurologico C. Besta, Milan, Italy, ⁸11. Laboratorio des Signaux et Systèmes, Centrale Supélec, Gif-sur-Yvette, France, ⁹UNATI, Neurospin, Institut Joliot, CEA, Université Paris-Saclay, Gif-sur-Yvette, France, ¹⁰Institute for Cancer Genetics, Columbia University Medical Center, New York, NY, New York, USA, ¹¹Institute for Cancer Genetics, Columbia University Medical Center, New York, NY, New York, USA, ¹²Service de Neurologie 2, AP-HP, Hôpitaux Universitaires Pitié Salpêtrière-Charles Foix, Paris, France

Background and aims: Approximately 3% of gliomas harbor an oncogenic actionable FGFR3-TACC3 (F3T3) fusion. Their characteristics and prognostic remains still poorly defined. We aimed to unravel the clinical, radiological and molecular profile of F3T3-positive diffuse gliomas.

Methods: We screened for F3T3 by RT-PCR 1162 diffuse gliomas (951 unselected, 211 selected for FGFR3 protein immunopositivity). Available clinical and molecular data were collected. We performed a radiological and radiomic case-control study.

Results: We identified 80 F3T3-positive gliomas (Table1). F3T3 fusion was exclusively found in IDH wildtype gliomas (80/843 versus 0/193, p<0.001). F3T3 appeared mutually exclusive with EGFR amplification (0/55 versus 156/558 of F3T3-negative cases, p<0.001), whereas associated with CDK4 amplification (10/46 versus 28/530, p<0.001) and MDM2 amplification (9/46 versus 18/578, p<0.001), creating a defined molecular cluster (Figure1). F3T3-positive gliomas showed a longer overall survival than F3T3-negative gliomas (median OS 29.1 versus 20.5 months, p=0.04), even when analysis was restricted to glioblastomas (31.1 versus 19.9 months, p=0.02), Figure2. Multivariate analysis confirmed F3T3 as an independent predictor of favorable outcome. In radiogenomic analysis, F3T3 associated with poorly defined tumor margins and a trend to spare eloquent areas. Radiomics analysis correctly classified F3T3-positive glioma with AUC of 0.82. We compared different Cox proportional hazards models using Harrel's C-Index: radiomics alone obtained a high C-Index (0.75); the model combining clinical, genetic and radiomic data showed the highest C-index (0.81).

Grade	n of detected FGFR3-TACC3 fusions/n samples tested	
	without prescreening for FGFR3 immunopositivity	prescreened for FGFR3 immunopositivity
II	2/104	4/9
III	1/129	5/27
IV	21/711	46/115
NA	0/7	1/60
	24/951 (2.5%)	56/211 (26.5%)

Table 1. Distribution of the 1162 screened diffuse gliomas according to WHO 2016 classification. Frequency of FGFR3-TACC3 fusions: 2.5% among unselected diffuse gliomas (grade II-IV); 26.5% among FGFR3-immunopositive cases.

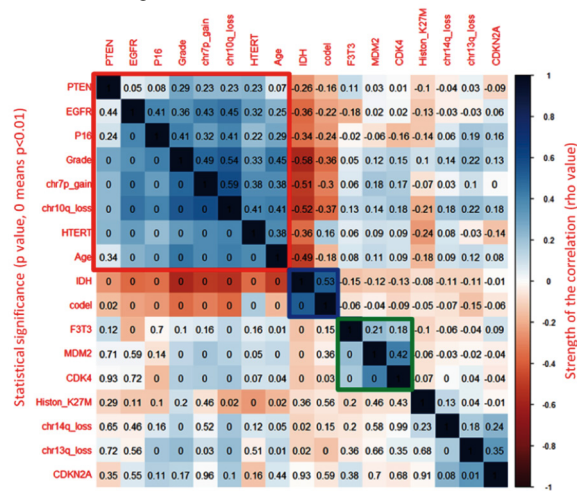

Figure 1. Correlation matrix (blue=positive, red=negative) of the main genetic alterations in 1162 diffuse gliomas. 3 main clusters were identified: EGFR amplification with 7p gain, 10q loss and older age at diagnosis (red), IDH mutation with 1p19q codeletion (blue), and F3T3 fusion with MDM2 and CDK4 amplifications (green).

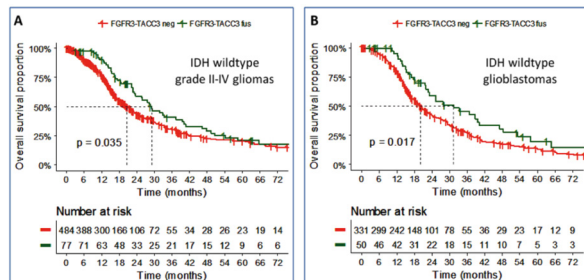

Figure 2. A) survival of IDH-wildtype diffuse glioma patients according to the F3T3 status (median OS 29.1 vs. 20.1 months; p=0.035). B) survival of IDH-wildtype glioblastoma patients according to the F3T3 status (median OS 31.1 vs. 19.9 months, p=0.017).

Conclusion: Diffuse gliomas harboring F3T3 gene fusions show specific molecular and radiological features, along with a less aggressive clinical evolution.

Disclosure: Nothing to disclose

EPR3130

Primary Central Nervous System Lymphoma: Epidemiological Analysis of a Series of Patients of University Hospital Center of Porto

M. Saraiva¹, M. Pinto², T. Ricardo³, M. Melo Pires⁴
¹Lisbon, Portugal, ²Neurologia, Hospital de Santo António, Porto, Portugal, ³Neuropatologia, Centro Hospitalar Universitário do Porto, Porto, Portugal, ⁴Neuropathology Unit, Centro Hospitalar do Porto, Hospital de Santo António, Porto, Portugal

Background and aims: Primary central nervous system lymphoma (PCNSL) is a subtype of extra-nodal non-Hodgkin lymphoma (NHL), rare but very aggressive with a 5-years survival of just 30% of patients. We intend to describe the epidemiological characteristics and estimate the survival time of patients diagnosed with PCNSL at the University hospital center of Porto (UHCP).

Methods: A retrospective analysis of a cohort of consecutive patients diagnosed with PCNSL between 2002 and 2019 was performed at UHCP. Descriptive statistics were applied for the demographic characterization of the sample and a survival analysis (Log-Rank and Cox Regression) was performed to estimate the mean survival time according to demographic data, clinical manifestations, histological type and imaging characteristics of the tumor.

Results: We identified 109 patients, 56.9% male, with a mean age of 60.5 years (SD 1.3). The median survival time after diagnosis was 34.4 months (SD 5.6). 15.6% of patients were immunocompromised. Histologically, 90% of the tumors correspond to diffuse large B-cell NHL. The most frequent inaugural clinical manifestation was focal neurological deficit. Among the factors analyzed, especially age, histological type, number of lesions, immune status and manifestations, an age greater than 65 years was the only independent prognostic factor ($p < 0.002$, 95% CI). It is noteworthy that the subgroup of immunosuppressed patients showed survival overlapping to the remaining.

Conclusion: These results corroborate the most recent data available in the literature, emphasizing the new epidemiological paradigm of the LPSNC as a tumor that is no longer associated with immunosuppressed young patients.

Disclosure: Nothing to disclose

EPR3131

Real-world experience with pregnancy in patients with glioma: a large retrospective study from the Pitié-Salpêtrière Hospital.

M. Scuccimarra¹, Y. Chalet², L. Capelle³, L. Feuvret⁴, K. Mokhtari⁵, N. Younan¹, D. Psimaras¹, C. Houillier¹, M. Sanson¹, P. J.-Y. Delattre¹, K. Hoang-Xuan¹, M. Dommergues², C. Dehais¹

¹Neuro-oncology, Pitié-Salpêtrière hospital, Paris, France, ²Service de Gynécologie-Obstétrique, Hôpital de la Pitié-Salpêtrière, Paris, France, ³Neurosurgery, Pitié Salpêtrière Hospital, Paris, France, ⁴GH pitie salpetriere, Paris, France, ⁵AP-HP, Groupe Hospitalier Pitié Salpêtrière, Laboratoire de Neuropathologie R Escourolle, Paris 75013, France., Paris, France

Background and aims: There is currently limited data on the influence of pregnancy on glioma patients. Specifically, whether the pregnancy might negatively affect the glioma behavior, and vice versa, is not known. The aim of this study was to assess the oncological and gestational outcomes of glioma patients becoming pregnant.

Methods: Patients with a known diagnosis of WHO grade II, III or IV glioma becoming pregnant between 2008 and 2019 were identified from the Pitié-Salpêtrière's hospital database. Retrospective data collection included clinical (age, Karnofsky status, neurological events, concomitant medication), radiological (location, size, contrast-enhancement), and histomolecular characteristics, oncological management (surgical procedure, radiotherapy, chemotherapy), progression-free survival, overall survival, and gestational outcome (preconception counseling, gestational age at diagnosis, obstetrical complications, pregnancy outcomes).

Results: We identified 22 pregnancies in 19 women with a known glioma (7 grade II, 10 grade III and 2 Grade IV). Treatments received before the pregnancy included surgery (n=17), radiotherapy alone (n=5), chemotherapy alone with temozolomide (n=3), and concomitant radiochemotherapy with temozolomide (n=4). 1 patient was treated with radiotherapy during the 2nd trimester of pregnancy. There were 7 terminations of pregnancy (6 of them due to concomitant tumor progression requiring immediate treatment), 15 live births and 3 maternal deaths within 6 months postpartum.

Conclusion: This study provides real-world data on the oncological and gestational outcomes of glioma patients becoming pregnant. In this series, termination of pregnancy was medically necessary for 27.3% of patients. Long-term outcomes of patients and their children will be presented at the conference.

Disclosure: Nothing to disclose

EPR3132

Incidence and characteristics of pseudoprogression in high-grade IDH-mutant gliomas

A. Seyve¹, C. Dehais², D.A. Idbaih³, D. Meyronnet⁴, K. Mokhtari⁵, A. D'hombres⁶, L. Feuvret⁷, S. Cartalat¹, J. Guyotat⁸, L. Capelle⁹, C. Carpentier¹⁰, J. Honnorat¹, D. Figarella-Branger¹¹, J.-Y. Delattre³, F. Ducray¹²

¹Neurooncology, Hospices Civils de Lyon, Lyons, France, ²Pitié Salpêtrière Hospital, Neuro oncology Mazarin, Paris, France, ³Service de Neurologie ², ¹-APHP, Groupe Hospitalier Pitié-Salpêtrière, Paris, France, ⁴Hospices Civils de Lyon, Lyons, France, ⁵Neuropathology, Pitié Salpêtrière, Paris, France, ⁶Radiotherapy, Hospices Civils de Lyon, Lyons, France, ⁷Paris, France, ⁸Neurosurgery, Hospices Civils de Lyon, Lyons, France, ⁹Neurosurgery, Pitié Salpêtrière Hospital, Paris, France, ¹⁰ICM, Paris, France, ¹¹APHM, Marseilles, France, ¹²Lyons, France

Background and aims: Pseudoprogression (PsP) after radiochemotherapy has been well-described in IDH-wildtype glioblastomas but its characteristics in IDH-mutant high-grade gliomas (HGGs mIDH) remain to be fully described. **Methods:** We retrospectively analyzed the characteristics of 212 HGGs mIDH treated with radiotherapy ±chemotherapy in 2 centers (Lyon and Paris) from the POLA network. PsP was defined as the increase or the appearance of a contrast-enhanced lesion after radiotherapy that disappeared or remained stable during follow-up (for at least 6 months) without initiation of a new oncological treatment.

Results: Our series consisted of 105 (50%) anaplastic oligodendrogliomas IDH-mutant and 1p19q-codeleted 60 (28%) anaplastic astrocytomas IDH-mutant n=60 (28%) and 47 (22%) glioblastomas IDH-mutant. After a median follow-up of 4.3 years (range: 1-10 years), 41 patients (19%) developed a PsP, that occurred after a median delay of 10 months after radiotherapy (range: 1-66 months) and lasted a median of 6 months (range: 2-30 months). PsP typically occurred in asymptomatic patients (93%), consisted of nodular (83%) and <1cm (83%) contrast-enhanced lesions that demonstrated no rCBV elevation (76%) on perfusion MRI and no hypermetabolism (90%) on 18FDOPA petscan. PsP was more frequent in patients who received PCV chemotherapy after radiotherapy than in those who did not or received temozolomide (26 vs. 10%, p<0.02).

Conclusion: PsP is frequent in HGGs mIDH, especially in patients treated with radiotherapy and PCV chemotherapy. PsP in this population typically present as small nodular contrast-enhanced lesions in asymptomatic patients. Its timing seems to be delayed compared to PsP in IDH-wildtype glioblastomas.

Disclosure: Nothing to disclose

EPR3133

Paraneoplastic Myeloneuropathies: characterization of a distinguishable phenotype and clinical outcomes

S. Shah¹, S.J. Pittock², A. McKeon³, N. Kumar¹, E. Flanagan², V. Lennon², D. Dubey⁴, C. Klein⁴, R. Vazquez Do Campo⁵

¹Rochester, USA, ²Mayo Clinic, Rochester, USA, ³Neuroimmunology, Mayo Clinic, Rochester, USA, ⁴Department of Neurology, Mayo Clinic College of Medicine, Rochester, USA, ⁵Department of Neurology, Mayo Clinic College of Medicine, Rochester, MN, USA

Background and aims: To describe an identifiable phenotypic presentation, serological and oncological associations of paraneoplastic myeloneuropathies.

Methods: We analyzed patients with co-occurring myelopathy and peripheral neuropathy seropositive for onconeural autoantibodies, and/or a diagnosis of cancer within 3 years of symptom onset and compared to a historical cohort of copper-deficiency metabolic myeloneuropathies.

Results: Among 32 patients presenting with paraneoplastic myeloneuropathy, 26 had detectable onconeural antibodies (Amphiphysin, 8; ANNA1/anti-Hu, 6; CRMP5, 5; PCA1/anti-Yo, 2; PCA2/MAP1B, 1; Kelch-like-Protein-11, 1; combinations thereof: ANNA1 and CRMP5, 1; ANNA1 and Amphiphysin, 1; ANNA3 and CRMP5,1). Among seropositive cases, 19 had underlying malignancy (small-cell lung cancer, 10) and seven had masses suspicious for malignancy but no histopathological cancer diagnosis. All 6 patients without classified onconeural antibodies (unclassified neural-autoantibodies, 3) had malignancies. Asymmetric numbness, with dysesthesias, weight loss, bowel/bladder dysfunction, sensory ataxia and hyperreflexia were common presenting symptoms. Neuropathies were non-length dependent, asymmetric, and painful. Inflammatory CSF was noted in 82%. Tract-specific changes on cervical/thoracic MRI were seen in 12/29(41%) patients. In comparison to copper-deficiency myeloneuropathy (n=11), asymmetric, sensory presentations, subacute progression, weight loss, orthostatic intolerance, inflammatory CSF and gadolinium enhancement of spinal cord or lumbosacral roots were significantly more frequent in paraneoplastic myeloneuropathies (p≤0.05). Median modified-Rankin-Score at last follow-up was 3. 10 of 28 patients (35%) were wheelchair dependent at last follow-up (median duration, 9 months)

Conclusion: A paraneoplastic etiology should be considered in the differential of subacute, progressive presentations of co-occurring myelopathy and neuropathy. Onconeural antibody and malignancy screening may aid in cancer diagnosis and guide management.

Disclosure: to be added

Neurorehabilitation; Spinal cord and root disorders

EPR3134

Aripiprazole Improves Spinal Cord Injury in Rats: Involvement of Inflammatory Pathways

A. Rismanbaf¹, K. Afshari², M. Ghasemi³, N.-S. Haddadi², A. Dehpour², H. Shafaroodi⁴

¹Department of Pharmacology and Toxicology, School of Pharmacy, Tehran Azad University of Medical Sciences, Tehran, Iran, Islamic Republic of, ²Experimental Medicine Research Center, Tehran University of Medical Sciences, Tehran, Iran, Islamic Republic of, ³Department of Neurology, University of Massachusetts Medical School, Worcester, USA, ⁴Department of Pharmacology, School of Medicine, Tehran University of Medical Sciences, Tehran, Iran, Islamic Republic of

Background and aims: Neuroinflammation causing central macrophages and microglia imbalance may underlie spinal cord injury (SCI) pathology. There is evidence that aripiprazole (ARP) has anti-inflammatory property. Therefore, the aim of the present study was to assess the therapeutic anti-inflammatory effects of ARP on a rat model of SCI.

Methods: Male Wistar rats underwent T9 vertebra laminectomy. They were divided into 4 groups: a sham-operated and 3 treatment (normal saline as a vehicle control versus ARP 10mg/kg and ARP 20mg/kg) SCI groups. Through a 28-day period, we then assessed locomotor scaling and behavioral tests for neuropathic pain. At the end of the study, tissue samples were evaluated for neuroinflammatory changes using the immunohistochemistry, flow cytometry, and ELISA techniques.

Results: Post-SCI ARP (10 and 20mg/kg) treatment markedly improved locomotors ability ($P<0.01$) and reduced sensitivity to mechanical ($P<0.01$) and thermal allodynia ($P<0.001$). Additionally, ARP treatment significantly decreased tumor necrosis factor (TNF)- α level and increased interleukin (IL)-10 level in spinal cord tissue compared to control groups 28 days post SCI ($P<0.01$). ARP treatment also markedly reduced expression of M1, increased M2 macrophages, and decreased of M1/M2 ratio in both dorsal root ganglion and spinal cord tissue after SCI compared to controls ($P<0.01$).

Conclusion: Our data revealed a therapeutic effect of ARP treatment on SCI and showed its potential to reduce neuroinflammation as well as SCI sensory/locomotor complications.

Disclosure: The authors declare no conflicts of interest regarding the data presented. This study was funded and supported by a grant (Grant No. 983081) from National Institute for Medical Research Development (NIMAD) in Iran.

EPR3135

Combination of non-invasive brain stimulation with standard physical rehabilitation in acute ischemic stroke

F. Iodice¹, R. Di Iorio², C. Erra³, M. Masson-Trottier⁴, F. Vecchio⁵, F. Miraglia⁵, P.M. Rossini⁶

¹Fondazione Policlinico Gemelli, IRCCS, Rome, Italy, ²Fondazione Policlinico Gemelli, IRCCS, Rome, Italy, ³UOSA Neuroriabilitazione ad Alta Intensità, Fondazione Policlinico Universitario Agostino Gemelli IRCCS, Rome, Italy, ⁴Centre de Recherche, Institut Universitaire de Gériatrie de Montréal & École d'orthophonie et d'audiologie, Faculté de Médecine, Université de Montréal, Montréal, QC, Canada, ⁵Brain Connectivity Laboratory, IRCCS San Raffaele Pisana, Rome, Italy, ⁶Department of Neurology, IRCCS San Raffaele Pisana, Rome, Italy

Background and aims: Arm and hand deficits are among the most disabling consequences in the everyday life of people affected by acute ischemic stroke (AIS). Non-invasive brain stimulation techniques (NIBS) showed potential benefits but experiences are limited to small populations in the chronic phase after injury.

Methods: 48 consecutive patients affected by AIS with upper limb impairment within 72 hours were consecutively randomized to receive real or sham bi-hemispheric tDCS for 15 sessions, 3 weeks, 5days/week for 20min/day in a 1:1 ratio. Upon their admission to the stroke unit, they were clinically assessed with NIHSS, ARAT, Fugl-Meyer, Barthel Index. As soon as possible they received a 2-month standard physical rehabilitation program paired with of either real- or sham-tDCS and tested again as baseline after 2 months.

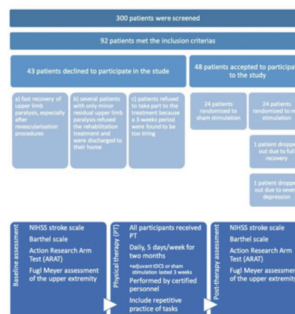

Figure 1: description of precedure used for the randomized clinical trial

Results: NIHSS didn't change in both groups. ANOVA analysis revealed in the "real" group a significant improvement in ARAT ($t_{ARAT}=5.025$, $p=0.03$) and Fugl-Meyer score ($t_{FM}=7.441$, $p=0.01$) but Barthel was not significantly improved ($t_{Barthel}=0.531$, $p=0.600$). In the "Real" group, effect was stronger for subtests depending on less fine movements: ARAT sub-tests gross movement ($p=0.010$) improved more than grasp ($p=0.025$) and grip ($p=0.041$) and Fugl Meyer sub-tests of the upper extremity ($p=0.006$) improved more than hand ($p=0.042$) and coordination and speed ($p=0.022$).

Conclusion: A 3 weeks treatment with bi-hemispheric tDCS added to standard physical rehabilitation in the early phases after AIS resulted in a slight improvement of upper limb motor functions with stronger effects on less fine movements.

Disclosure: Nothing to disclose

EPR3136

Eye know about your Neglect: Eyetracking during free visual exploration detects neglect more reliably than paper-pencil tests

B. Kaufmann¹, D. Cazzoli¹, T. Pflugshaupt², S. Bohlhalter², T. Vanbellingen³, R. Müri⁴, T. Nef³, T. Nyffeler⁵

¹Department of Neurology, University of Bern, Switzerland, Perception and Eye Movement Laboratory, Berne, Switzerland, ²Luzerner Kantonsspital, Neurocenter, Lucerne, Switzerland, ³ARTORG Center for Biomedical Engineering Research University of Bern, Gerontechnology and Rehabilitation Group, Berne, Switzerland, ⁴Department of Neurorehabilitation, University of Bern, Inselspital, Berne, Switzerland, ⁵Department of Neurology, University of Bern, Perception and Eye Movement Laboratory, Berne, Switzerland

Background and aims: Neglect after stroke is most accurately diagnosed by systematic, ecological observation during everyday behaviour using the Catherine Bergego Scale (CBS). However, CBS is time-consuming and often omitted in clinical settings, especially stroke units. In this study, we aimed to explore if video-oculography during free visual exploration (FVE), which can be performed in few minutes, is sensitive in mirroring neglect in everyday behaviour and whether it is more sensitive than conventional neuropsychological paper-pencil-tests.

Methods: In this retrospective, observational, multicentre study, we identified 78 patients with subacute right-hemispheric stroke, with and without neglect in everyday behaviour, as diagnosed by the CBS, who also performed FVE. 40 age-matched healthy participants served as controls. The sensitivity to detect neglect was compared between FVE and conventional neuropsychological paper-pencil-tests, i.e. Random-Shape-Cancellation, Line-Bisection, 2-Part-Picture, Bells, Star-Cancellation, Letter-Cancellation, Sensitive-Neglect, Five-Point.

Results: FVE (in particular, mean gaze position) correctly identified neglect in 85% of patients, with an AUC value of 0.927 in ROC analysis. Conventional neuropsychological paper-pencil-tests, considered alone or in combination, showed heterogeneous results, and identified neglect significantly less often (21.74%-68.75%). Moreover, there was a significant correlation between mean gaze position and CBS, providing evidence for the relationship between FVE and neglect in everyday behaviour.

Conclusion: FVE has a high sensitivity and specificity to diagnose neglect and it is more sensitive than conventional neuropsychological paper-pencil-tests. It can be performed in short time and has the potential to be used as a fast and accurate screening tool that allows the initiation of comprehensive neuropsychological diagnostics and neurorehabilitative therapy from early on.

Disclosure: Nothing to disclose

EPR3137

Evaluation of serum BDNF in patients with ischemic stroke after motor rehabilitation using augmented reality

E. Koroleva¹, V. Alifirova¹, I. Tolmachev¹, S. Ivanova², N.G. Brazovskaya¹

¹Department of neurology and neurosurgery, Siberian State Medical University, Tomsk, Russian Federation, ²Laboratory of Molecular Genetics and Biochemistry, Mental Health Research Institute, Tomsk, Russian Federation

Background and aims: Brain neurotrophic factor (BDNF) is a neuroplasticity factor. BDNF plays a crucial role in motor training and recovery after a stroke. Augmented reality (AR) is a new tool for using sensory stimuli during motor training with biofeedback.

Arm: to identify the correlation between the BDNF content in blood serum and motor neurological symptoms after rehabilitation upper and low extremity by using specialized software Rehab.

Methods: 68 patients in early recovery period of ischemic stroke (average age 63 (57-65) years; Rankin Scale=3 (2-3) points, NIHSS=4 (3-6) points, Asworth=0 - 1 points. The course of motor rehabilitation-10 days, 1 training session-60 minutes. Observation points: I-before, II-after rehabilitation. Neurological examination was completed with Fugl-Meier Assessment scale (FMA). Serum BDNF was determined by MAGPIX multiplex analyzer (Luminex, USA) using xMAP® Technology.

Results: FMA I=199 (190-212) points; FMA II=213 (208-222) points, $p<0.005$. Increment of FMA I-II=12 (9-19) points. FMA sum upper extremity: I=49 (43-57) points; II=61 (56-64) points, $p=0.005$. FMA sum low extremity: I=29 (27-33) points; II=33 (29-34) points, $p=0.046$. BDNF I=1110.0 (679,9–1484.0) pg/ml; BDNF II=2745,0 (1730.0–2739.0) pg/ml, $p=0.022$ - associated with stimulation of the motor cortex as a result of motor training. Strong positive correlation was found between the changes in the level of serum BDNF and quantitative values on FMA ($r=0.610$, $p=0.027$) in patients with ischemic stroke after AR motor rehabilitation.

Conclusion: The results confirm the activation of neuroplasticity processes and the effectiveness of motor rehabilitation with biofeedback based on sensory AR stimuli and the principle of motor learning.

Disclosure: This study was supported by the Russian Science Foundation (RSF), grant No. 18-15-00082 “Laboratory for robotic rehabilitation”



RehabAR for low extremity

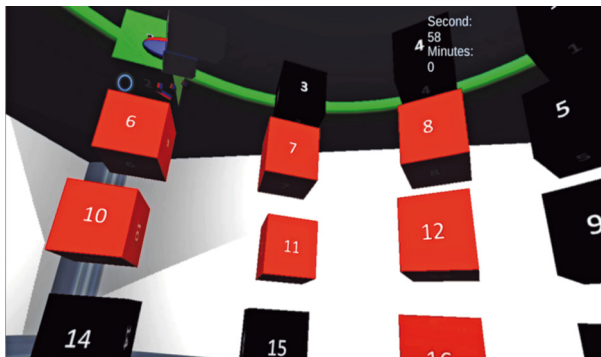

RehabAR for upper extremity

EPR3138

Transcranial direct current stimulation add-on to neurorehabilitation of Pisa syndrome in Parkinson's disease

A. Putorti¹, R. De Icco¹, M. Allena², M. Avenali¹, C. Dagna¹, V. Grillo², S. Cristina², C. Tassorelli¹

¹Neurorehabilitation Unit - Department of Brain and Behavioral Sciences, IRCCS Mondino Foundation - University of Pavia, PAVIA, Italy, ²Neurorehabilitation Unit, IRCCS Mondino Foundation, Pavia, Italy

Background and aims: Pisa Syndrome (PS) is a lateral trunk flexion associated to Parkinson's disease (PD). Transcranial Direct Current Stimulation (t-DCS) is a non-invasive neuromodulation technique, with promising results in focal dystonia. Aim of our study is to evaluate the role of t-DCS as add-on to neurorehabilitation in PS.

Methods: 20 patients affected by PD and PS (15 male, age 72.0±4.9 years, disease duration 8.2±5.6 years, duration of PS 2.8±1.9 years) were managed with neurorehabilitation combined with: 1) t-DCS group (5 daily sessions - 20 minutes - 2mA) with cathode over the M1 cortex contralateral to PS and anode over the M1 cortex ipsilateral to PS; 2) SHAM group. Patients were tested with UPDRS-III, FIM, EMG and cinematic motion analysis at hospital admission (T0) and after 1 month of neurorehabilitation (T1). The study groups were comparable for clinical/demographic and EMG features. At T1 we find a significant reduction of anterior and lateral trunk flexion in both groups (p=0.001 and 0.013 respectively), and an increase of range of motion (ROM) of the trunk bending ipsilateral to trunk deviation (p=0.008).

Results: At T1 the overall improvement in lateral and anterior trunk flexion in upright standing position was higher in the t-DCS group when compared to SHAM group (p=0.032); moreover, the improvement of trunk ROM in the medio-lateral plane was higher in the t-DCS group (p=0.038). The UPDRS-III and FIM scores significantly improved at T1 in both groups.

Conclusion: Our data supports the use of neuromodulation with t-DCS as add on to neurorehabilitation for the treatment of PS.

Disclosure: Nothing to disclose

EPR3139

Rehabilitation of complex arm movement after Ischemic Stroke using haptic device and Virtual Reality (VR)

J. Krivec¹, T. Kolar¹, T. Poposek¹, T. Oresnik¹, J. Karlovsek¹, M. Rakusa²

¹Thermana d.d., Lasko, Slovenia, ²Department of Neurology, University Medical Centre Maribor, Maribor, Slovenia

Background and aims: rehabilitation in VR enables patients to perform complex arm movement with online feedback. Aim of our study was to evaluate the feasibility of rehabilitation of complex arm movement, using Bimeo.

Methods: 22 patients were included 3 weeks after ischemic stroke. All patients underwent standardised physio-, occupational therapy and rehabilitation in VR using Bimeo. Each patient performed 2 sessions in VR, lasting 4min each. Patients were seated in front of the screen, holding Bimeo in their affected hand. On the screen, a labyrinth appeared, and they have to navigate the cursor to the end of the labyrinth as fast and as accurate as possible.

For each patient, the modified Rankin score (mRS), movement quality index (MQI), smoothness, accuracy, and overall score were measured. All parameters except overall score and mRS were normalised on the scale from 0 to 10, where 10 represents optimum. Differences between sessions were compared with paired t-test.

Results: mean age of patients was 66.7±12.1 years. At the end of rehabilitation mRS significantly improved (1.7±0.7 vs 1.5±0.5 p<0.05). After the 2nd training session, significant improvement in the smoothness (6.7±2.1 vs 7.6±2.0), the accuracy of arm movement (7.2±1.4 vs 7.5±1.0) and overall score were observed (319±173 vs 427±213 points). No improvement was found in MQI.

Conclusion: our study demonstrates that rehabilitation in the VR may improve complex movement already after 2 sessions. In the future, an optimal number of sessions should be determined.

Disclosure: Nothing to disclose

EPR3140

Non traumatic spinal cord injury in Northern Tanzania: burden and etiology

I. Rego Garcia¹, W.P. Howlett², M.C.J. Dekker²

¹Neurology Unit, Hospital Universitario Virgen de las Nieves, Granada, Spain, ²Internal Medicine, Kilimanjaro Christian Medical Centre, Moshi, Tanzania, United Republic of

Background and aims: Acquired non-traumatic spinal cord injury (NT SCI) has a huge burden of disease regardless geography. Few recent studies are available on epidemiology of medical paraplegia on Sub-Saharan Africa (SSA). The purpose of this study is dual: we aim to support the fact that NT SCI causes an important proportion of neurological burden in our settings, and describe the etiologies with the hypothesis that it presents as an end consequence of several medical conditions.

Methods: Retrospective cross-sectional hospital-based study. Patients aged 13 years and above were recorded when presenting with neurological complaints and attended the medical outpatient department or were admitted to a referral and teaching hospital in Kilimanjaro region, during the 6 years study period, April 2007 to March 2013.

Results: Out of 2047 neurological patient records a total of 294 (14.4%) presented with paraplegia/quadruplegia 2ndary to NT SCI. Among NT SCI, malignancy (20%), transverse myelitis (12%) and Pott's disease (6%) were the most common identified etiologies. More than 50% of the cases could not have an etiological diagnosis. HIV infection was present in 20.4% of those patients presenting with PP who were tested (143/294).

Conclusion: NT SCI accounts for a significant proportion of neurological disorders in Northern Tanzania. NT SCI is associated with HIV infection in this study in particular with unexplained paraparesis and Pott's disease. The absence of neuroimaging in particular magnetic resonance imaging made it difficult to reach an etiological diagnosis in many cases.

Disclosure: Nothing to disclose

EPR3141

Validation of the SECONDS: a new short scale to assess disorders of consciousness

C. Aubinet, H. Cassol, O. Bodart, L.R.D. Sanz, S. Wannez, C. Martial, A. Thibaut, G. Martens, M. Carrière, O. Gosseries, S. Laureys, C. Chatelle
Liege, Belgium

Background and aims: Clinical examination of severely brain-injured patients with disorders of consciousness (DoC) requires repeated standardized assessments to provide an accurate diagnosis. However, the administration time of the current gold-standard Coma Recovery Scale-Revised (CRS-R) limits its use in clinical routine. We here propose and validate a faster tool to assess consciousness.

Methods: The Simplified Evaluation of CONsciousness Disorders (SECONDS) is based on 6 mandatory items (observation, response to command, visual fixation, visual pursuit, oriented behaviours, arousal) and 2 conditional items (localisation to pain, communication) (Figure 1). 57 DoC patients were assessed 4 times on 2 consecutive days: 1 CRS-R and one SECONDS were administered on 1 day, whereas 2 SECONDS were administered on the other day (Figure 2). The 3 examiners remained blind to diagnosis and medical history of patients. Concurrent validity and inter-/intra-rater reliability were computed using weighted kappa coefficients, while administration times for the SECONDS vs. CRS-R were compared with a Mann-Whitney U test.

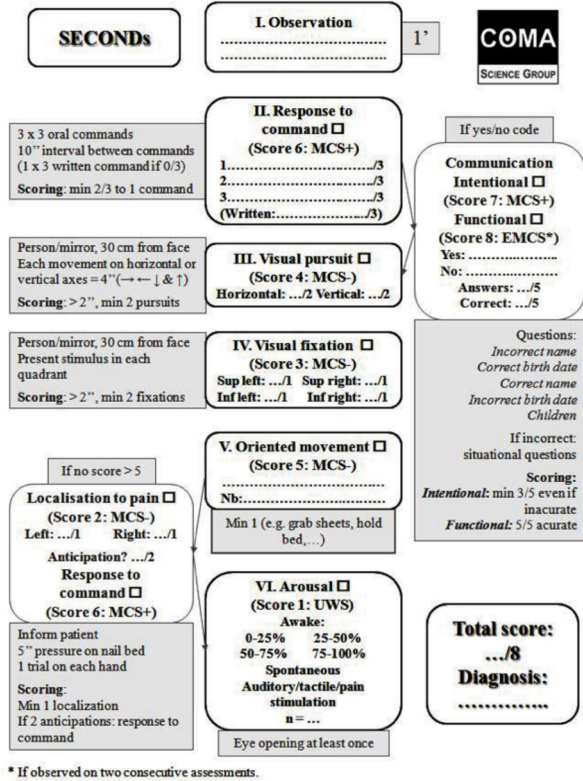

Figure 1. Administration of the Simplified Evaluation of CONsciousness Disorders. We recommend the administration of at least 5 SECONDS in a short time period (e.g., 10 days) to reduce misdiagnosis rates. UWS=unresponsive wakefulness syndrome; MCS-/MCS+=minimally conscious state minus/plus; EMCS=emergence from the minimally conscious state.

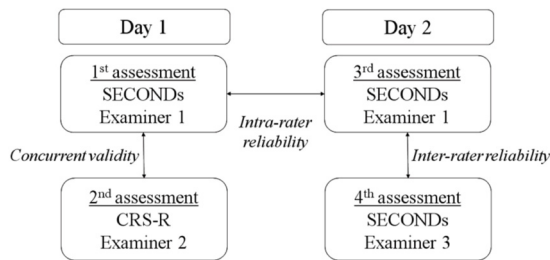

Figure 2. Procedure and validation protocol of the SECONDS. 3 SECONDS and 1 CRS-R were administered by 3 examiners on 2 consecutive days. The 2nd exam was always administered 45-60 minutes after the 1st. The order of the assessments (within a day and between days) and the order of the examiners were pseudo-randomized.

Results: “Substantial” and “almost perfect” agreements (kappas: 0.78-0.85) were found comparing the CRS-R against the same-day SECONDS or against the highest-scoring SECONDS. Intra- and inter-rater reliabilities showed “almost perfect” agreements (kappas: 0.85-0.91 and 0.82-0.85 respectively) (Figure 3). Administration times were significantly shorter for the SECONDS than for the CRS-R (7min vs. 17min).

		Same day SECONDS				Best SECONDS			
		UWS	MCS-	MCS+	EMCS	UWS	MCS-	MCS+	EMCS
CRS-R	UWS	11	1	0	0	10	2	0	0
	MCS-	3	8	3	0	3	8	3	0
	MCS+	0	4	8	2	0	1	11	2
	EMCS	0	0	3	14	0	0	0	17

Figure 3. Comparison of the diagnoses obtained with the CRS-R vs. the SECONDS administered on the same day (left) and the CRS-R vs. the best SECONDS (right). Light grey cells show patients with a better diagnosis using the SECONDS and dark grey cells show patients with a better diagnosis using the CRS-R.

Conclusion: The SECONDS is a fast and valid clinical scale to evaluate patients with DoC. This new tool offers an alternative to existing scales, well-suited for clinicians with major time constraints, and can be easily repeated to provide an accurate diagnosis.

Disclosure: This study was supported by the University and University Hospital of Liège, the Belgian National Funds for Scientific Research (F.R.S-FNRS), the Marie Skłodowska-Curie Actions (H2020-MSCA-IF-2016-ADOC-752686), the European Union’s Horizon 2020 Framework Program for Research and Innovation under the Specific Grant Agreement No. 785907 (HBP SGA2), Luminous project (EU-H2020-fetopen-ga686764), the James McDonnell Foundation, the Public Utility Foundation ‘Université Européenne du Travail’, AstraZeneca Foundation, C.A. and L.S. are research fellows, A.T. is a post-doctoral fellow, and S.L. is research director at the F.R.S-FNRS.

EPR3142

A rationale for a use of non-medication in the patients with the post-stroke spastic muscle pain

O. Tondiy

Neurology and Child Neurology, Kharkiv Medical Academy of Postgraduate Education, Kharkiv, Ukraine

Background and aims: The effect of the non-medication complex on the patients having the pain due to post-stroke muscle spasticity was investigated.

Methods: 98 patients aged from 45 to 65 (41 males and 57 females) having the post-stroke pain due to muscle spasticity were observed. All patients suffered acute cerebrovascular accident in the form of brain stroke. The Ashworth Scale Spasticity: 2–3 points. The patients subjectively rated their spastic muscle pain from 3 to 7 points to the visual analogue scale (VAS). The patients were randomly divided into 2 groups. The 1st group (62 patients) received in addition their basic medication and physiotherapy with combination of ultratone therapy – variable sinusoidal high-tension (4-5 kV) high-frequency (22kHz) low-intensive current (power 1-10 Watt), and low-frequency variable magnetic field (frequency to 100 Hertz, magnetic induction 27mTesla) treatment of upper and lower extremities, with taking turn each other, and balneotherapy. Every procedure exposure was 12-15min. The complete course was 10-12 procedures. The 2nd group (control, 36 patients) received only the basic medication.

Results: The spasticity, subjective sensation of constraint extremities and pain due to post-stroke muscle spasticity of the patients in the 1st group was reduced after 25-30 days of treatment (77.4% patients) compared to the control group, where muscle constraint reduced after 32-42 days of treatment (58.3 % patients), $p < 0.05$.

Conclusion: The addition of the complex (ultratone therapy, balneotherapy and the low-frequency variable magnetic field) to the treatment resulted in earlier reducing of subjective sensation of constraint extremities and pain due to post-stroke muscle spasticity.

Disclosure: Nothing to disclose

EPR3143

Disturbances of micturition in patients with acute strokeK.I. Tudor¹, D. Petravić¹, M. Botica², S. Nađ Škegro³, M. Bakula³, F. Rajič⁴, F. Mustač⁵, B. Ribarić¹, M. Krbot Skoric¹

¹Department of Neurology, University Hospital Center Zagreb, School of Medicine University of Zagreb, Zagreb, Croatia, ²Department of Neurology, Neuropsychiatric Hospital “Dr Ivan Barbot”, Popovača, Croatia, ³Department of Urology, University Hospital Center Zagreb, School of Medicine University of Zagreb, Zagreb, Croatia, ⁴Croatian Football Federation, Zagreb Football Association, Zagreb, Croatia, ⁵The Croatian Institute of Emergency Medicine, Zagreb County, Croatia

Background and aims: Lower urinary tract symptoms (LUTS) are commonly reported in patients that suffer stroke and the aim of this study was to assess them.

Methods: This was a prospective case-control study performed at tertiary health-care center. LUTS, catheter insertion and diaper administration were monitored and recorded during hospitalisation for each patient.

Results: 49 patients that suffered acute stroke were included (33 women, 16 men; mean age 74.25 ± 10.93 (range 41-95) years), mean Barthel index (BI) 47.80 ± 42.79 (range 0-100). 87.8% (N=43) had ischemic stroke and 12.2% (N=6) hemorrhagic. 51.02% (N=25) had LUTS before the stroke, while 16 (32.65%) developed symptoms now (mean age 72.61 ± 11.99 (range 42-90) years). 28.57% (N=14) of patients had new onset urinary retention, while 2 (4.08%) patients reported new onset urinary incontinence (one mixed and 1 urge urinary incontinence). There were no significant differences between women and men in urinary retention ($\chi^2=1.758$, $df=2$, $p>0.05$) and in urinary incontinence ($\chi^2=3.692$, $df=2$, $p>0.05$). There were significant relationships between catheter and atrial fibrillation ($\chi^2=3.996$, $df=1$, $p=0.046$) and both catheter ($\chi^2=3.864$, $df=1$, $p=0.049$) and diaper use with arterial hypertension ($\chi^2=7.969$, $df=1$, $p=0.005$). Urinary incontinence was found to be significantly more often present with lesion in white matter ($\chi^2=4.622$, $df=1$, $p=0.032$) and insular lesion ($\chi^2=4.622$, $df=1$, $p=0.032$).

Conclusion: In our study majority of patients in the acute phase of stroke experienced urinary retention. Question rises of the proper timing of clean intermittent catheterisation (CIC) in post-stroke rehabilitation.

Disclosure: Nothing to disclose

Peripheral nerve disorders 2

EPR3144

The use of forks revisited: which one and how should we use them?

J. Perez Lucas¹, E. Miñano Guillamón²

¹Neurology, Hospital General de Villalba, Madrid, Spain,

²Neurology, Hospital Universitario Rey Juan Carlos, Madrid, Spain

Background and aims: We use different methods to explore vibratory sensitivity with quantitative or qualitative tuning forks, with little written evidence of their sensitivity (S) and specificity (E), and cut-off values. We propose to analyze the usefulness of these tests.

Methods: We include patients with an ENG request for suspected sensory polyneuropathy (PNP) between 11/11/18-30/03/19. Prior to the diagnostic test, we explore vibratory sensitivity in lateral malleolus (LM) with 2 tuning forks: 1 128Hz conventional fork (CF), recording time in seconds from its activation to patient's sensitive threshold, and the Rydel-Seiffer tuning fork (RSF), noting the scale value in patient's sensitive threshold. Subsequently, ENG was performed for diagnosis of PNP. Data were analyzed using the statistical package SPSS.



Image 1. The tuning forks used: on the right, the conventional one (CF) and on the left, the Rydel-Seiffer (RSF).

Results: 24 patients (45.8% women; mean age 57 years, average height 1.6m), of which 8 (33%) were diagnosed with PNP in ENG. There were no differences in sex and height between PNP/normal results, although in age, the affected were older. A statistically significant correlation was observed between sural sensory nerve action potential (SNAP) amplitude and the resulting value of the tuning forks (Graph 1). The area under the CF's curve was 0,67 (0.41-0.93) and RSF's was 0.86 (0.70-1) (Graph 2).

Optimum cut-off points for CF: 9s (S75%, E 71%) and for RSF 6Hz (S88%, E71%). Qualitative method (feel/no-feel vibration): S25%, E100%

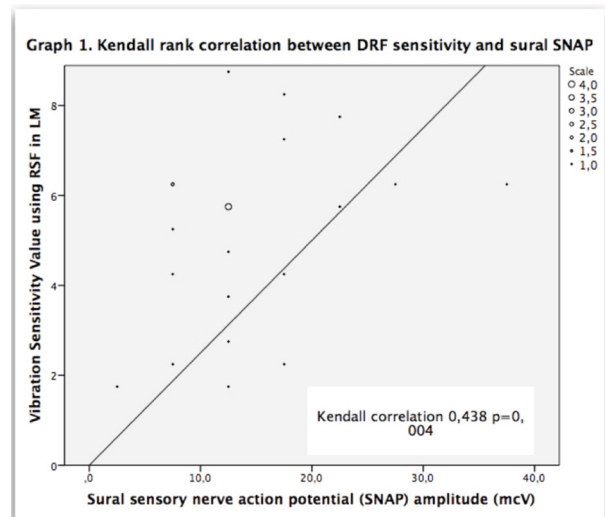

Graph 1. Linear correlation between sural SNAP amplitude and patient's sensitivity threshold measured with RSF.

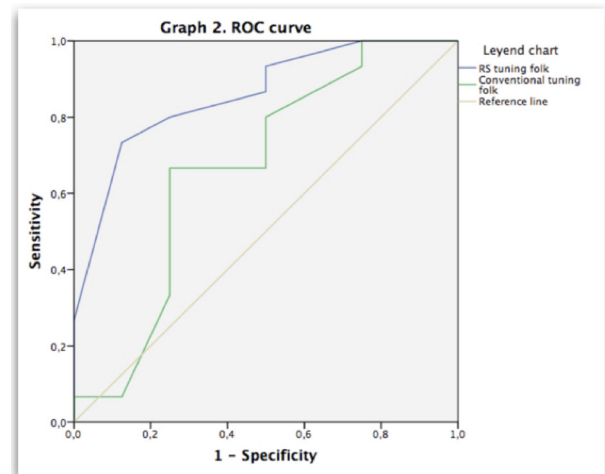

Graph 2. Receiver Operating Characteristics (ROC) curve of the 2 tuning forks.

Conclusion: In our experience, given the easy handling and better sensitivity of RSF, this tuning fork is shown as the best option for clinical use. Additionally, the diagnosis of PNP in ENG is quite unlikely if its result is normal.

Disclosure: Nothing to disclose

EPR3145

Variation of Penetrance in hereditary Transthyretin Amyloidosis (hATTR) between European countries: impact on the management of gene carriers

F. Gorram¹, M. Olsson², A. Mazzeo³, E. Cisneros-Barroso⁴, Y. Parman⁵, M. Waddington Cruz⁶, L. Gentile³, G. Vita³, I. Anan², A. Rodríguez-Rodríguez⁴, J. González-Moreno⁴, I. Losada⁴, P. Fanen⁷, F. Alarcon⁸, G. Nuel⁹, V. Planté-Bordeneuve¹

¹Department of Neurology Henri Mondor University Hospital APHP, Paris Est- Créteil University, Inserm U.955 Institut Mondor de Recherche Biomédicale (IMRB), Créteil, France, ²Department of Public Health and Clinical Medicine, Wallenberg Centre for Molecular Medicine, Umeå, Sweden, ³Department of Clinical and Experimental Medicine, University of Messina, Messina, Italy, ⁴Internal Medicine Department, Research Health Institute of the Balearic Islands (IdISBa), Son Llúzer University Hospital, Palma de Mallorca, Spain, ⁵Department of Neurology, Istanbul Faculty of Medicine, Istanbul University, Istanbul, Turkey, ⁶Department of Neurology, Federal University of Rio de Janeiro, Hospital Universitário Clementino Fraga Filho, Rio de Janeiro, Brazil, ⁷Department of Genetics Henri Mondor University Hospital APHP, Paris Est- Créteil University, Inserm U.955 Institut Mondor de Recherche Biomédicale (IMRB), Créteil, France, ⁸Laboratory MAP5 UMR CNRS 8145 Paris Descartes University, Paris, France, ⁹Institute of Mathematics, National Center for French Research, Laboratory of Probability, University Pierre et Marie Curie, Sorbonne University, Paris, France

Background and aims: hATTR is an autosomal dominant peyorative disease characterized by a wide range of age of onset. Early diagnosis is essential to initiate timely the newly available therapies. Hereby, unravel the risk of being affected (penetrance) is essential for the management of asymptomatic gene carriers (AGC). This collaborative study aimed to estimate penetrance in a panel of hATTR kindreds using a Non-parametric Survival Estimation method.

Methods: Genealogical data were collected in 340 families from Sweden, France, Portugal, Majorca, Sicily, Turkey and Brazil; including ATTR-Val30Met (N1=261 families); ATTR-Phe64Leu (N2=20); ATTR-Ser77Tyr (N3=20); ATTR-Ile107Val (N4=14); ATTR-Ser77Phe (N5=10); ATTR-Thr49Ala (N6=9) and ATTR-Glu89Gln (N7=9).

Results: Penetrance ranged broadly between the ATTR-Val30Met families. In the Swedish and French subsets, the risk was below 5% until 30 y-o increasing progressively to 70% at 80 y-o. Penetrance raised dramatically from 11% at age 25 years to 68% at 50 y-o, up to 95% at 80 y-o, in the Portuguese families. The estimates were intermediate in the Majorcan kindred.

Considering the Parent-of-origin, penetrance was significantly higher when maternally inherited in the Swedish and Portuguese ATTR-Val30Met families.

Penetrance varied significantly between the non-V30M ATTR variants, increasing rapidly from 30-35 y-o up to

90% at 80 y-o in ATTR-Glu89Gln and ATTR-Thr49Ala families. In the ATTR-Ser77Phe, ATTR-Ser77Tyr and ATTR-Phe64Leu families, the risk increased after 45 y-o (8%) to 71-94% at 80 y-o. Penetrance estimates were the lowest in the ATTR-Ile107Val families raising after age 50 years.

Conclusion: Our results are important to structure the monitoring for AGC according to their geographical origin and the TTR variant.

Disclosure: Nothing to disclose

EPR3146

Comparative study of patients with an acute-onset chronic inflammatory demyelinating polyneuropathy vs. acute inflammatory demyelinating polyneuropathy in Russian population.

N. Suponeva¹, A. Rizvanova¹, D. Grishina², M. Piradov¹
¹Moscow, Russian Federation, ²Peripheral nerve disorders, Research Center of Neurology, Moscow, Russian Federation

Background and aims: Up to 16% of CIDP patients may start acutely (A-CIDP) mimicking AIDP. Currently, there are few data to distinguish A-CIDP from AIDP at the onset. We aimed to describe differences in these patients in an acute period.

Methods: We performed a retrospective chart review of 17 A-CIDP and 30 AIDP adult patients from March 2002 to November 2019.

Results: We analysed 47 charts of adult patients consisting of 17 A-CIDP and 30 AIDP. The mean age of patients was lower in A-CIDP group (A-CIDP 34 years vs. AIDP 48 years) with a slight prevalence of women (A-CIDP 57% vs. AIDP 42.3%, $p < 0.05$). No significant differences were found in MRCss between 2 groups (A-CIDP 52.7 vs. AIDP 55.4, $p < 0.05$), but A-CIDP patients were not likely to present pain at the onset and less often required artificial ventilation. 52.9% of patients with A-CIDP showed mainly proximal conduction blocks (CB) on nerve conduction study (NCS) and 17.6% were initially diagnosed as AMAN. No significant differences in protein level in CSF were observed. 47% of A-CIDP patients required repetitive and/or combined courses of immunotherapy. Notably despite of therapy there was a progression of CB and 2ndary axonal involvement on NCS in these patients.

Conclusion: There are still low data to distinguish A-CIDP at the onset. But, according to our study, patients with AIDP with mainly proximal CB on NCS with poor response to the initial therapy need a close follow-up regarding A-CIDP.

Disclosure: Nothing to disclose

EPR3147

Peripheral neuropathy while use different methods of insulin therapy in diabetes mellitus type 1

N. Ruzhdi, E. Barantsevich
 Neurology and manual medicine, I.P.Pavlov First Saint Petersburg State Medical University, Saint-Petersburg, Russian Federation

Background and aims: Dysmetabolic peripheral neuropathy manifested by polyneuritic symptoms like a feet pain, cramps, numbness, is 1 of most common neurological conditions caused by diabetes mellitus. The aim of the study is a comparative analysis of development of polyneuropathy in patients with type 1 diabetes mellitus (T1DM) who

receive continuous subcutaneous insulin infusion (CSII) and multiple daily insulin injections (MDII).

Methods: The study included 100 patients aged 29 ± 11 years with the disease duration 14.25 ± 9.25 , the level of HbA1c 9.5 ± 1.5 %. The 1st group (N=50) consisted of patients were on MDII for 11.3 ± 5.4 , last 4.5 ± 1.5 with CSII. The 2nd group (N=50) of patients with MDII for 12.7 ± 7.7 . The assessment was performed using Neuropathy Symptoms Scores (NSS), Neuropathy Disability Score (NDS), Total Symptoms Score (TSS).

Results: CSII-group had lower polyneuritic signs and symptoms in comparison with MDII-group on 29% by NSS, 76% by TSS, 50% by NDS (Table 1, Figure 1) ($p < 0.05$).

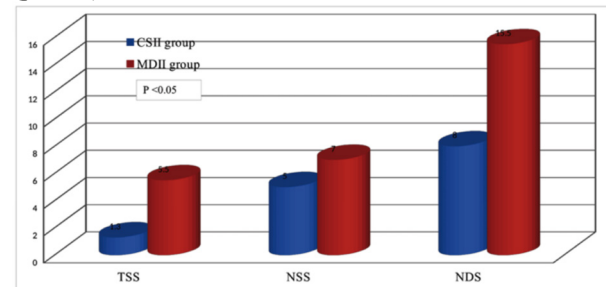

Figure 1. Test results in the study groups

Score	CSII group	MDII group
TSS	1.3 (0; 3.3)*	5.5 (4.7; 7)*
NSS	5 (0; 6)*	7 (6; 8)*
NDS	8 (6; 10)*	15.5 (14; 23)*

($p < 0.05$)

Table 1. Comparative results of neuropathic assessment in the groups.

Conclusion: The comparative analysis of the development peripheral nervous system complications of diabetes mellitus type 1 with use different methods of insulin therapy has revealed significant differences in the presence and severity of signs and symptoms of polyneuritic dysfunction, which indicate the advantages of use CSII in terms of prevents of development of dysmetabolic polyneuropathy in T1DM.

Disclosure: Nothing to disclose

EPR3148

Nerve ultrasound in transthyretin amyloidosis: possible diagnostic red flags.

A. Salvalaggio¹, D. Coraci², M. Cacciavillani³, L. Obici⁴, M. Luigetti⁵, A. Mazzeo⁶, F. Pastorelli⁷, M. Grandis⁸, G. Bisogni⁹, L. Gentile¹⁰, R. Plasmati¹¹, C. Gemelli¹², D. Pareyson¹³, S. Fenu¹⁴, T. Cavallaro¹⁵, G.M. Fabrizi¹⁶, C. Martinoli¹⁷, L. Padua⁵, C. Briani³

¹University of Padova, Padua, Italy, ²Cattolica University, Rome, Italy, ³Padua, Italy, ⁴Amyloidosis Research and Treatment Center, Fondazione IRCCS Policlinico San Matteo, Pavia, Italy, ⁵Rome, Italy, ⁶Neurology, University of Messina, Messina, Italy, ⁷IRCCS Istituto delle Scienze Neurologiche di Bologna, Bologna, Italy, ⁸Genoa, Italy, ⁹Centro Clinico NEMO, Rome, Italy, ¹⁰Department of Clinical and Experimental Medicine, University of Messina, Messina, Italy, ¹¹Bologna, Italy, ¹²Clinica Neurologica, Genoa, Italy, ¹³Istituto Neurologico C. Besta, Milan, Italy, ¹⁴Milan, Italy, ¹⁵Dep. of Neurosciences, Biomedicine and Movement, University of Verona, Verona, Italy, ¹⁶VERONA, Italy, ¹⁷University of Genova, Genoa, Italy

Background and aims: The most common neurological manifestations of hereditary transthyretin amyloidosis (ATTR) are axonal symmetric polyneuropathy and carpal tunnel syndrome (CTS). Onset of CTS may occur several years before the diagnosis of amyloidosis. Idiopathic CTS is very common (prevalence of 10%) thus making it difficult an early diagnosis of TTR-related CTS. Also, the accurate monitoring of the asymptomatic ATTR carriers is of great importance in order to detect early signs of disease onset. The 1st aim of our study was to identify possible ultrasound morphological pattern of CTS in ATTR. The 2nd aim was to assess whether extensive nerve ultrasound evaluation would help identify peculiar patterns in ATTR patients and carriers.

Methods: Patients and carriers with TTR mutation were enrolled from several Italian centers. Severity of CTS was assessed with neurophysiology and clinical scales. Median nerve cross-section area (CSA) was measured with ultrasound in ATTR patients and controls (idiopathic CTS). Morphological ultrasound changes were also recorded along whole nerves trunks at four limbs in patients and carriers.

Results: 62 subjects (34 men) with TTR gene mutation were recruited. While in idiopathic CTS a direct correlation between neurophysiological CTS severity and median nerve CSA ($r=0.55$, $p<0.01$) was found, in ATTR subjects median nerve CSA did not correlate with CTS severity. Increased CSA were detected in brachial plexus bilaterally in patients with polyneuropathy but not in carriers ($p<0.001$).

Conclusion: The results of the present study identify and quantify morphological patterns which can be useful in the early diagnosis and in monitoring the carriers in the ATTR.

Disclosure: This study was supported by Pfizer

EPR3149

Compound nerve conduction Z-scores: Sensitivity in polyneuropathy

T.H. Sand¹, A. Grötting², M. Engström³, K. Todnem⁴, R. Michler⁴, K.B. Nilsen⁵

¹Department of Neuroscience, Norwegian University of Science and Technology, Trondheim, Norway, ²Trondheim, Norway, ³INB, NTNU, Trondheim, Norway, ⁴Department of Neurology and Clinical Neurophysiology, Trondheim, Norway, ⁵Oslo, Norway

Background and aims: Combining several nerve conduction variables into one Z-score can be used to diagnose polyneuropathy (PNP). However, the optimal combination to be selected in clinical practice, from available nerves regarding motor and sensory amplitudes and velocities and F-wave latencies, is not known. Our aim was to compare diagnostic sensitivity for motor and sensory variables and several combinations thereof.

Methods: 92 consecutive patients with confirmed PNP, 21 with diabetes, 13 with cancer, 37 with other diseases and 21 idiopathic, were included. Motor velocities, amplitudes and F-waves were recorded from median, ulnar, tibial and peroneal nerves. Sensory amplitudes and velocities were obtained from median, ulnar, radial, sural, peroneal and medial plantar nerves. Single values and individual age and height-corrected Z-scores were computed for several combinations and compared with 366 control subject data.

Results: Motor nerve sensitivities were rather low. Sensory nerve sensitivities were higher in the leg, ranging from 31 to 73%. The highest sensitivities were found for combined Z scores, ranging from 64-84%. The largest sensitivity was found for a combination of 6 sensory leg parameters (velocity and amplitude), ulnar sensory amplitude, motor peroneal and tibial amplitudes, tibial and ulnar F-wave latencies, and peroneal distal motor latency.

Conclusion: Sensory nerve conduction studies in the legs are generally the most sensitive for the diagnosis of PNP, and amplitude-parameters are more sensitive than conduction velocities. The problems with multiple variable testing can efficiently be solved by the application of combined Z-score variables. Compound Z-scores seem to be the most efficient way to diagnose PNP.

Disclosure: Nothing to disclose

EPR3150

Role of MYD88 L265P mutation in chronic paraproteinemic peripheral neuropathies.

E. Schirinzi¹, C. Simoncini¹, C. Baratè², M.R. Metelli², R. Calabrese³, G. Siciliano¹

¹Department of Clinical and Experimental Medicine, University of Pisa, Pisa, Italy, ²Department of Clinical and Experimental Medicine, Section of Hematology, University of Pisa, Pisa, Italy, ³Department of Clinical and Experimental Medicine, Neurological Clinic, University of Pisa, Pisa, Italy

Background and aims: MYD88 gene (myeloid differentiation factor 88) encodes for a protein involved in the proliferation of memory B-cells. A somatic point mutation of the MYD88 gene, leading to an amino acid change from leucine to proline (L265P), has been reported in 90% of patients with Waldenström disease (MW) and in 50% of patients with IgM MGUS, frequently associated with a peripheral neuropathy. The aim of the study has been to investigate the role of the MYD88-L265P mutation in relation to the clinical features of peripheral neuropathy associated with MW and MGUS IgM.

Methods: 20 patients, with a diagnosis of polyneuropathy associated to an IgM monoclonal peak, carried out at the time of diagnosis genetic test searching for the MYD88 L265P mutation. Total levels of serum IgM, light chains and anti-MAG antibodies were related to neurological and haematological disease signs and electroneurographic parameters. All patients, classified in mild, moderate or severe phenotype according to their deambulation ability and MRC score, underwent a clinical and electrophysiological 12 months follow-up.

Results: Patients with MYD88 gene mutation presented a milder clinical course and a milder involvement of the electrophysiological parameters. A significant difference ($p < 0.05$) was found in the deep peroneal nerve motor conduction velocity between patients with and without MYD88 mutation. No significant difference was found regarding total IgM levels, light chain subtype, and anti-MAG antibodies titer.

Conclusion: Although suggestive, further studies need to clarify the putative protective role of MYD88L265P mutation where associated with a milder clinical course in these forms of paraproteinemic neuropathies.

Disclosure: Nothing to disclose

EPR3151

CMT caused by MORC2 mutations in Spain

R. Sivera¹, V. Lupo², M. Frascuet Carrera³, J. Alonso⁴, J. Diaz-Manera⁴, M.D.M. Garcia-Romero⁵,

T. Garcia-Sobrino⁶, L. Querol⁴, C. Paradas⁷, S.I. Pascual Pascual⁵, J.J. Vilchez³, T. Sevilla³

¹Neurology, Hospital Francesc de Borja, Gandia, Spain, ²Instituto de Investigación Principe Felipe (CIPF), Valencia, Spain, ³Neurology, Hospital Universitari i Politecnic La Fe, Valencia, Spain, ⁴Unidad de Enfermedades

Neuromusculares; Servicio de Neurología, Hospital de la Santa Creu i Sant Pau de Barcelona, Barcelona, Spain,

⁵Neurology, Hospital La Paz, Madrid, Spain, ⁶Neurology, Hospital Clínico de Santiago de Compostela, Santiago de

Compostela, Spain, ⁷Neuromuscular Unit, Department of Neurology, Hospital U. Virgen del Rocío/Instituto de Biomedicina de Sevilla, Seville, Spain

Background and aims: MORC2 mutations are a rare cause of inherited neuropathies that was 1st recognized in 2016.

The aim of this work is to determine the frequency and distribution of these mutations throughout Spain, to provide a comprehensive phenotypical description, and if possible, to establish a genotype-phenotype correlation.

Methods: Retrospectively, we detected all the patients diagnosed with this CMT subtype in the Instituto de Investigación Principe Felipe in Valencia, as well as the patients introduced in a national CMT database. A call for collaboration was also issued in the Neuromuscular Disorder Study Group in the Sociedad Española de Neurología. After informed consent, clinical, electrophysiological, neuroimaging, and pathological data was collected and analysed.

Results: 15 patients with causal MORC2 mutations were detected throughout Spain. 7 belonged to a single kindred, but the rest were sporadic. 60% harboured the most common p.Arg252Trp mutation, while in 4 cases novel mutations were detected. In 2 patients (p.S87L, p.Y394C) the phenotype was an early onset, severe, predominantly motor neuropathy with developmental delay in 1. In the rest, the phenotype was similar, with onset before 30 years, early proximal involvement and asymmetric muscle involvement. Nerve conduction studies revealed an unequivocally axonal neuropathy with patchy denervation. Muscle imaging corroborated the proximal and asymmetric fatty infiltration, and CPK levels were usually increased.

Conclusion: MORC2 mutations are a rare cause of CMT in Spain, but in-depth phenotyping reveals a recognizable pattern that may be clinically relevant for future recognition of this disease.

Disclosure: Nothing to disclose

EPR3152

Rationale and Design of NEURO-TTRansform, a phase 3 study evaluating the efficacy and safety of AKCEA-TTR-LRx in patients with hereditary transthyretin-mediated Amyloid Polyneuropathy (hATTR-PN)

L. Tai¹, L. Obici², J. Gillmore³, N. Viney¹, C. Monteiro¹, G. Buchele¹, M. Brambatti¹, S. Tskimikas¹, S. Jung¹, L. O'dea⁴, E. Schneider¹, R. Geary¹, B. Monia¹

¹Clinical Development, Ionis Pharmaceuticals, Carlsbad, USA, ²Amyloidosis Research and Treatment Center, Fondazione IRCCS Policlinico San Matteo, Pavia, Italy, ³Medicine, University College London, London, United Kingdom, ⁴Clinical Development, Akcea Pharmaceuticals, Boston, USA

Background and aims: hATTR-PN is a progressive and fatal polyneuropathy caused by misfolding and aggregation of transthyretin (TTR) systemically. Inotersen (Tegsedi™) is an approved antisense therapeutic that inhibits TTR production. AKCEA-TTR-LRx shares the same oligonucleotide sequence as inotersen but is conjugated to a triantennary N-acetyl galactosamine (GalNAc) moiety for receptor-mediated delivery to hepatocytes, site of TTR production. NEURO-TTRansform (NCT04136184) is a phase 3 global, open-label study that aims to determine safety and efficacy of AKCEA-TTR-LRx compared to a historical placebo-control group for the treatment of hATTR-PN.

Methods: ~140 hATTR-PN patients will be randomized to receive either AKCEA-TTR-LRx or inotersen. Key inclusion criteria include preserved ambulatory status, confirmed TTR mutation, and Neuropathy Impairment Score (NIS) 10-130. Endpoints include changes in: serum TTR concentration, modified NIS+7 and Norfolk Quality of Life-Diabetic Neuropathy at Week 66 with an interim analysis at Week 35. 2ndary endpoints include the change from baseline in the Neuropathy Symptom and Change Score, Physical Component Summary score of 36-Item Short Form Survey, and Modified Body Mass Index.

Results: In a phase 1 study, monthly dosing of AKCEA-TTR-LRx at 45 mg demonstrated a mean reduction of 86% from baseline in serum TTR with no clinically relevant changes in platelet, renal, or hepatic parameters. Based on these results, the phase 3 trial has been initiated.

Conclusion: NEURO-TTRansform evaluates safety and efficacy of AKCEA-TTR-LRx for the treatment of hATTR-PN, a disease for which there is still a need for effective, well-tolerated, and convenient treatments.

Disclosure: This trial is supported by Ionis Pharmaceuticals

EPR3153

The reliability and reproducibility of corneal confocal microscopy

E. Vlckova¹, A. Rajdová¹, M. Nemeč Jr.², J. Bednarik¹
¹Neurology, Masaryk University and University Hospital Brno, Brno, Czech Republic, ²Grammar school Brno-Reckovice, Brno, Czech Republic

Background and aims: The aim of the study was to assess the intra- and interobserver reliability of particular parameters of corneal innervation evaluated by corneal confocal microscopy (CCM).

Methods: 30 patients with malignant lymphoma 6 months after the end of anticancer treatment containing neurotoxic vinca-alkaloids (17 men, 13 women, mean age 39 years, range 19-69) were examined using CCM. Corneal nerve fiber density (CNFD) and length (CNFL), the density of corneal nerve branches (CNBD) and nerve fiber tortuosity coefficient (TC), were evaluated by 2 independent observers in 2 different settings: image-level (where the same set of samples was evaluated repeatedly) and patient-level (where each observer chose his/her own set of samples from each patient).

Results: The intraclass correlation coefficients (ICCs) were excellent for intra-observer image-level reliability (0.956 to 0.994) and high for patient-level evaluation (0.583 to 0.852). The inter-observer reliability was slightly lower for image-level setting (ICCs 0.757-0.968), while for patient-level setting, the ICCs were similar to intra-observer reliability (0.618 to 0.910). CNFL was the most reliable parameter (both for intra- and interobserver evaluation). The ICC values in our study were very close to previous studies published mainly in diabetic neuropathy patients. The Bland-Altman plots showed minimal bias between observers.

Conclusion: Corneal confocal microscopy showed very good inter- and intra-observer reliability of most of the parameters evaluated. CNFL is the most reliable CCM parameter. Our findings thus confirmed the results of previous studies in a different group of patients.

Disclosure: Supported by MH_CZ_DRO, FNBr, 65269705.

EPR3154

Incidence, Prevalence, Pattern, and Outcome of AIDP(GBS)and CIDP among Peripheral Neuropathic Libyan Patients at BMC

S. Zoubi

Neurology, Benghazi Medical Center, Benghazi, Libya

Introduction: Peripheral neuropathy, in the broadest sense, refers to a range of clinical syndromes affecting a variety of peripheral nerve cells and fibers.

Objectives: To evaluate the prevalence, incidence, pattern and outcome of AIDP and CIDP with the all PNP patients at BMC

Methods: A retrospective study for 493 peripheral neuropathy patients who presented and followed up in neurology clinic or- being admitted.

Results: The estimated prevalence of PNP patients is 33/100,000 population, M:F ratio PNP 1:2, peak age group is in the middle 2nd, 3rd and 4th decade (25-50 years), the mean age at 37 years. the most common PNP is due to CTS and Diabetic PNP (30.4 and 21.1% respectively), the overall prevalence for GBS/CIDP is 1.8/100.000 (in which GBS 0.3 /100,000 and CIDP 1.5/100,000), the incidence for GBS/CIDP is 0.4/100,000, M:F for GBS/CIDP 1:0.9, the most common pattern is symmetrical weakness (52.2%), The outcome of GBS/CIDP patients using Erasmus and (INCAT) Disability Score shows the predominant outcome range between 3 to 5.

Conclusion(s): The prevalence of PNP and GBS/CIDP is in keeping with various international figures, with incidence for GBS/CIDP of 0.4/100,000. It increases with age, females affected > males in PNP 2:1, while in GBS/CIDP there is slight male predominance 0.9:1, the most common PNP is CTS (30.4%) and diabetic PNP (21.1%), the most common pattern is the symmetrical weakness for GBS/CIDP (52.2%), with disability outcome score from 3 to 5.

Disclosure: Nothing to disclose

Sleep disorders 3

EPR3155

Disrupted Nighttime Sleep (DNS) in Pediatric Narcolepsy

F. Pizza¹, K. Maski², A. Colclasure³, E. Steinhart², E. Little², C. Diniz Behn³, S. Vandi¹, E. Antelmi¹, G. Plazzi¹, T. Scammell²

¹Department of Biomedical and Neuromotor Sciences, Università di Bologna - Alma Mater Studiorum, Bologna, Italy, ²Boston Children's Hospital, Boston, MA, Boston, USA, ³Department of Applied Mathematics and Statistics, Colorado School of Mines, Golden, CO, Golden, USA

Background and aims: Disrupted nighttime sleep (DNS) is a core symptom of narcolepsy in adult patients that to date lacks a validated polysomnographic measure and not yet investigated in young patients. Here, we assess the construct validity of various DNS objective measures and evaluate its diagnostic utility for pediatric Narcolepsy Type 1 (NT1) when combined with a nocturnal Sleep Onset REM period (nSOREMP) in a large cohort of pediatric patients with CNS hypersomnias.

Methods: Retrospective, cross-sectional study of consecutive polysomnograms (PSGs) and multiple sleep latency tests (MSLTs) obtained in Boston and Bologna. Participants were drug-free, ages 6-18 years and slept at least 6 hours during the PSG. We analyzed associations between objective DNS measures and outcomes of self-reported sleep disturbance, Epworth Sleepiness Score, MSLT sleep latency, NT1 diagnosis, and CSF hypocretin values when available. We then combined the best performing DNS measure with the presence of a nSOREMP to determine the diagnostic value for NT1 using bootstrap analysis. We included n=151 NT1, n=21 narcolepsy type 2 (NT2), n=27 idiopathic hypersomnia (IH) and n= 117 controls in this analysis.

Results: Across groups, the Wake and NREM 1 bouts index had the most robust associations objective sleepiness, subjective sleep disturbance and CSF hypocretin levels ($p < 0.0001$). From 1000 bootstrap samples, the Wake/N1 index and nSOREMP have greater diagnostic accuracy for NT1 than the nSOREMP alone ($p < 0.0001$).

Conclusion: A Wake and NREM 1 bout index is a good objective measure of DNS. Combined nSOREMP and this DNS measure can improve screening for pediatric NT1 and potentially reduce diagnostic delays.

Disclosure: This study was supported by an investigator initiated grant from Jazz Pharmaceuticals, Inc and National Institutes of Health (NINDS, K23 NS104267-01A1) both awarded to Dr. Maski.

EPR3156

Telemedicine with mobile internet devices for innovative multidisciplinary patient-centred care of patients with narcolepsy. Protocol of the randomized controlled trial TENAR (TElemedicine for NARcolepsy)

F. Ingravallo¹, L. Vignatelli², U. Pagotto¹, S. Vandi¹, A. Mangiaruga¹, M. Moresco³, C. Zanesini⁴, F. Pizza⁵, G. Plazzi²

¹University of Bologna, Bologna, Italy, ²Bologna, Italy, ³Biomedical and Neuromotor Sciences (DIBINEM), university of Bologna, Bologna, Italy, ⁴IRCCS Istituto delle Scienze Neurologiche di Bologna, Bologna, Italy, ⁵Department of Biomedical and Neuromotor Sciences, Università di Bologna - Alma Mater Studiorum, Bologna, Italy

Background and aims: Narcolepsy is a rare chronic sleep disorder. Severe endocrine-metabolic and psychosocial aspects are intrinsic to the disease and require a multidisciplinary approach. Given the scarce number of specialized Sleep Centres worldwide, the disease burden is increased by the need for traveling for medical consultations, with high costs for patients and families. Telemedicine may be an important resource for both patients and clinicians. The TENAR trial is the 1st randomized controlled trial (RCT) designed to evaluate feasibility, efficacy, safety and costs of a Telemedicine multidisciplinary approach for the management of narcolepsy.

Methods: Open RCT assessing the non-inferiority of the multidisciplinary management of narcolepsy via Video Consultation (VC) through Mobile Telemedicine devices compared to usual in-office care. 202 children and adults with narcolepsy will be randomly allocated in 1:1 ratio to VC or to in-office usual care for a 12 months follow-up. At baseline, all patients will undergo a neurologic, metabolic and psychosocial assessment. Primary (i.e., excessive daytime sleepiness according to the Epworth Sleepiness Scale) and secondary endpoints (i.e., other symptoms, metabolic control, quality of life, patient and family satisfaction with care, feasibility, safety and costs) will be measured at 6 and 12 months.

Results: We expect the Telemedicine approach not only to be non-inferior for sleepiness control but also to significantly improve other patient-centred outcomes compared to the usual in-office care.

Conclusion: TENAR will provide 1st evidence of feasibility, efficacy, safety and costs of Telemedicine for the management of patients with narcolepsy.

Disclosure: This study is supported by a grant of the Italian Ministry of Health "Ricerca Finalizzata" (490.000 euro)

EPR3157

Narcolepsy with intermediate hypocretin levels: clinical and polysomnographic phenotype of 52 patients

E. Postiglione¹, L. Barateau², F. Pizza³, R. Lopez², M. Filardi¹, M. Moresco⁴, Y. Dauvilliers², G. Plazzi³

¹Department of Biomedical and Neuromotor Sciences, Università di Bologna - Alma Mater Studiorum, Bologna, Italy, ²Montpellier, France, ³Biomedical and Neuromotor Sciences (DIBINEM); IRCCS Istituto delle Scienze Neurologiche, Bologna, university of Bologna, Bologna, Italy, ⁴IRCCS-Istituto delle Scienze Neurologiche di Bologna, Bologna, Italy

Background and aims: Narcolepsy is a chronic disorder currently classified in type 1 and type 2 based on the presence of excessive daytime sleepiness, established Multiple Sleep Latency Test (MSLT) findings, and either on the presence of cataplexy or cerebrospinal-fluid hypocretin deficiency (CSF-hcrt1 < 110pg/mL). We aimed to explore the clinical and polysomnographic features of narcoleptic patients with intermediate hypocretin levels.

Methods: We collected clinical, neurophysiological and biological data of suspected narcoleptic patients referred to French and Italian National Reference Centres for narcolepsy with at least 1 night of polysomnography (PSG) followed by the MSLT, and CSF-hcrt1 comprised between 110 to 200pg/ml. 52 subjects (5 children) were identified. 50% of them fulfilled the MSLT diagnostic criteria for narcolepsy, 78% carried the HLADQB1*06:02 haplotype. The mean delay between the disease onset and CSF-hcrt1 evaluation was 11.3 y.

Results: 7 subjects reported familial narcolepsy (parents affected with either NT1 or NT2), 2 subjects DNMT1 gene mutations and 4 subjects autoimmune/lesional forms. Cataplexy (atypical in 41.4%) was present in 55.8%. Patients with cataplexy displayed worse disturbed nighttime sleep at nocturnal PSG. Subjects without cataplexy frequently reported sleep drunkenness and prolonged nocturnal sleep time. BMI was not different between groups. Patients with cataplexy presented more SOREMPs at nocturnal PSG and at MSLT compared to those without cataplexy.

Conclusion: Narcolepsy patients with intermediate hypocretin levels represent a heterogeneous population. The high rate of cataplexy in patients with CSF-hcrt1 comprised between 110 to 200pg/ml challenges the current classification.

Disclosure: Nothing to disclose

EPR3158

Altered sleep in a group of patients affected by Pediatric acute-onset neuropsychiatric syndrome (PANS)

P. Congiu¹, N. Ronzano², F. Cera², M. Tanca², C. Garau¹, A. Zuddas², A. Gagliano², M.M.F. Puligheddu¹

¹Dipartimento di Scienze Mediche e Salute Pubblica - Università di Cagliari, Centro di Medicina del Sonno, Cagliari, Italy, ²Unità di Neuropsichiatria dell'infanzia e dell'adolescenza - Dipartimento di Scienze Biomediche - Università di Cagliari & Ospedale Pediatrico - Cagliari, Cagliari, Italy

Background and aims: Sleep disorders represent 1 of the most frequent manifestations in pediatric acute-onset neuropsychiatric syndrome (PANS), but very few polysomnographic studies have been conducted in this population. The aim of this study is to describe nocturnal sleep and identify any sleep disorders in a cohort of patients affected by PANS.

Methods: 23 PANS patients with a drug-free period of at least 4 weeks were consecutively enrolled. They underwent a comprehensive anamnestic and sleep habits history, a complete laboratory and neuropsychological assessment, and a complete full-night polysomnography recording (PSG).

Results: 74% showed PSG alterations. Specifically, 47% have ineffective sleep, 58.8% fragmented sleep, 47% a Periodic Limb Movement Disorder condition, and 64.7% a REM Sleep Without Atonia. 82.6% of the patients received a diagnosis of Tic Disorder/Tourette's Disorder, which was strongly correlated with the presence of a sleep disorder. Lab analysis showed high prevalence of infectious markers (Anti-Chlamydia Pneumoniae and ASLO titer) and of vitaminD deficiency, with a strong link between vitaminD deficiency, infectious markers and the sleep alterations.

Conclusion: This study confirms that sleep disorders are very frequent in PANS, representing a cardinal symptom. Results of this work lead us to hypothesize an inflammatory/dysimmune pathogenesis of sleep disorders in these patients. Sleep disturbances have been associated with a wide range of cognitive, mood and behavioral impairments, and low school performances. Therefore, evaluation of sleep since the early stages of the disease should be mandatory in these patients in order to improve quality of sleep and daytime performances.

Disclosure: Nothing to disclose

EPR3159

Determinants of excessive daytime sleepiness in restless legs syndrome

A.L. Rassin¹, S. Chenini¹, R. Lopez¹, L. Barateau¹, L. Guiraud¹, C. Cavailles², I. Jaussent², Y. Dauvilliers¹
¹Neurology, Sleep Unit, Montpellier, France, ²University of Montpellier, Montpellier, France

Background and aims: Restless legs syndrome (RLS) is a neurological sensorimotor disorder characterized by uncomfortable sensations in the legs worsening in the evening, often associated with periodic limb movements during sleep (PLMS). RLS may result in sleep disturbances (insomnia and sleep fragmentation), but also excessive daytime sleepiness (EDS). We aimed to determine which factors predict subjective and objective EDS in RLS.

Methods: 97 consecutive untreated RLS patients (58.76% females, mean age 55.49±13.11 years) underwent a polysomnography (PSG) and an evaluation of RLS severity and depressive symptoms (BDI). EDS was assessed via the Epworth sleepiness scale (ESS>10/24=subjective EDS) and via the multiple sleep latency test (MSLT≤8minutes=objective EDS).

Results: The mean ESS score was 11.03±5.58, with half of the patients having subjective EDS (51 patients, 53.13%). The mean MSLT latency was 13.7±4.61min, with objective EDS in 14 subjects (14.43%). Patients with subjective EDS had shorter mean MSLT latency compared to non-sleepy patients (12.7±4.55 vs. 14.22±4.56min, p=0.04). No differences were seen between subjectively sleepy and non-sleepy patients on demographic, PSG parameters and RLS severity scale; however patients with ESS>10 had higher BDI scores.

Objective sleepiness was associated with older age and disease duration. PSG showed shorter sleep duration, reduced sleep efficacy, higher wake after sleep onset, microarousal index and PLMS index in objectively sleepy patients.

Conclusion: The presence of subjective EDS is frequent in RLS patients and associated with depressive symptoms. In contrast, objective sleepiness is less frequent, associated with older age and disease duration, worse sleep quality, higher sleep fragmentation and PLMS.

Disclosure: Nothing to disclose

EPR3160

Childhood onset REM sleep behavior disorder, ocular saccades disorder and facial development abnormalities: a new syndrome?

S. Rossi¹, P. Morselli², C. La Morgia³, F. Pizza³, G. Neccia³, M. Seri⁴, P. Avoni³, R. Liguori³, G. Plazzi³
¹Department of Biomedical and Neuromotor Sciences (DIBINEM), University of Bologna, Bologna, Italy, ²Department of Plastic Surgery, University of Bologna and S. Orsola-Malpighi Hospital, Bologna, Italy, ³Department of Biomedical and Neuromotor Sciences, Università di Bologna - Alma Mater Studiorum, Bologna, Italy, ⁴University of Bologna, Sant'Orsola-Malpighi Hospital, Medical Genetic Unit, Bologna, Italy

Background and aims: Originally described in older patients, REM behavior sleep disorder (RBD) is now recognized as a condition that can affect childhood in association with some conditions, such as narcolepsy type 1, antidepressant medication use, structural brainstem abnormalities (e.g. midline tumors) or neurodevelopmental disorders (e.g. autism spectrum disorder). We report a patient presenting with a childhood onset sleep disturbance suggesting RBD.

Methods: A 26-year-old female was referred for a sleep disturbance characterized by episodes of screaming, vocalization and non-stereotyped movements of limbs occurring during the night, since the age of 5. She is affected from scoliosis and ankyloglossia. She had no family history of neurological or sleep disorder.

Results: Clinical and neurological evaluation revealed nasal voice and ocular flutter aggravated by lateral fixation. Oral cavity examination revealed high-arched palate and ankyloglossia. Brain MRI was unremarkable. A 48h video-PSG revealed a normal night-sleep architecture with loss of physiological REM-sleep muscle atonia and repeated episodes of vocalization and motor behaviors during all REM sleep episodes, typical of RBD. Multiple sleep latency test (MSLT) excluded excessive daytime sleepiness. Skin biopsy searching for p- α syn deposits was negative.



Fig.1: Images showing ankyloglossia (left panel) and high-arched palate (right panel)

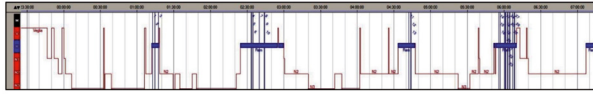

Fig.2: Hypnogram of the patient, showing normal night-sleep architecture. Five REM-sleep episodes were recorded during the night. Vertical bars and numbers indicate major episodes of abnormal motor behavior during REM sleep.

Daytime sleep	
Daytime TST (min)	0
Number of naps	0
REM latency (min)	0
Overnight recording	
Sleep efficacy (%)	95.76%
TST (hours)	7.20
Sleep latency (min)	9
REM latency (min)	85
PLM index	2.32
REM atonia index	0.466 (n.v. ≥ 0.9)
MSLT	
SL	20
SOREMP	0

Tab.1 48h video-PSG and MSLT findings. TST, total sleep time; SE, sleep efficiency; REM, rapid eye movements sleep; PLMI, periodic limb movements index; MSLT, multiple sleep latency test; SL, sleep latency; SOREMPs, sleep onset REM periods.

Conclusion: This case could represent a new syndromic condition in which scoliosis and oral abnormalities coexist with a brainstem dysfunction accountable for congenital RBD and ocular flutter. The association of RBD and saccade disorder strongly suggests a lateral pontine tegmentum dysfunction. An unknown genetic or developmental disorder could underlie a functional or structural, even if not detectable with MRI-scan, abnormality in the dorsal pons responsible for this peculiar phenotype.

Disclosure: Nothing to disclose

EPR3161

Ambient temperature (Ta) manipulation as a novel technique to dissociate REM sleep and cataplexy in narcolepsy

B. Viberti¹, L. Branca¹, C.L. Bassetti², A. Adamantidis¹, M. Schmidt²

¹Bern, Switzerland, ²Department of Neurology, Inselspital, Bern University Hospital and University of Bern, Bern, Switzerland

Background and aims: The lateral hypothalamic melanin-concentrating hormone (MCH) system is critical for maximizing REM sleep during thermoneutral ambient temperature (Ta) warming (Komagata et al. Curr. Biol., 2019). Given the role of the hypocretin (Hcrt) system in MCH inhibition, we hypothesized that Hcrt loss in narcolepsy may enhance REM expression or cataplexy during Ta warming. We thus investigated REM sleep expression as a function of Ta during both light (inactive) and dark (active) phases in wild-type (WT), MCH receptor 1 knock-out (MCHR1-KO) and narcoleptic Hcrt-KO mice.

Methods: Mice were implanted for sleep-wake monitoring with additional video recording for cataplexy and actigraphy analyses. Thermoneutral Ta warming bouts were presented during the light or dark phases as previously described (Curr. Biol., 2019).

Results: WT mice significantly increased REM sleep with Ta warming during the light phase, but not the dark phase. Unexpectedly, we found an opposite circadian responsiveness pattern in Hcrt-KO mice, showing increased REM sleep only during the dark phase. Additionally, narcoleptic mice significantly decreased cataplexy during Ta warming. As expected, MCHR1-KO mice did not respond to Ta warming during either circadian phase.

Conclusion: Narcoleptic mice demonstrate a reversed circadian REM sleep responsiveness pattern to Ta warming compared to WT mice. Moreover, Hcrt-KO mice show a dissociation of REM sleep and cataplexy with Ta manipulation, i.e., increasing REM sleep and decreasing cataplexy during warming. These data suggest unique neural mechanisms for REM sleep and cataplexy and that Ta manipulation is a novel technique to modulate their expression for clinical or research aims.

Disclosure: Nothing to disclose

EPR3162

The value of the pupillary unrest index as a screening tool for assessing fitness to drive

D. Schreier, D. Andres, A. Hertig-Godeschalk, A. Mathis, C. Roth, J. Mathis

Dept. of Neurology, Inselspital, Berne, Switzerland

Background and aims: Sleepiness contributes to around 20% of car crashes in industrialised nations. However, its quantification remains challenging and reliable, cheap, and practical assessment methods are urgently sought. This study aimed to determine the accuracy of the pupillary unrest index (PUI) as a screening measure to assess fitness to drive in sleepy patients.

Methods: We retrospectively (1997-2016) analysed clinical data of untreated patients with narcolepsy-cataplexy and narcolepsy without cataplexy (NC=30, N=28), idiopathic hypersomnia (IH=47), non-organic hypersomnia (NOH=103), fatigue syndromes (FS=94), and insufficient sleep syndromes (ISS=53). The mean sleep latency in the maintenance of wakefulness test (MWT-SL) was used as the gold standard and the PUI as testing variable. We defined a private (PRIV-M) and a professional driver model (PROF-M) according to the following MWT-SL and PUI cut-off values: $\geq 20\text{min}/<9.80$ (PRIV-M), $\geq 34\text{min}/<6.64$ (PROF-M).

Results: The PUI in the PRIV-M or PROF-M reached a sensitivity of 0.52 or 0.63, a specificity of 0.80 or 0.58, a positive predictive value (PPV) of 0.51 or 0.69, and a negative predictive value (NPV) of 0.8 or 0.52. According to ROC-curves, PUI cut-off values (6.64 - 9.8) were within the optimal range.

Conclusion: The PUI was more accurate in the PRIV-M, however, 20% of the patients with an 'acceptable' PUI were not able to stay awake for 20min in the MWT. Therefore, our data suggest that the PUI should not be used as a screening measure to assess fitness to drive in sleepy patients.

Disclosure: Nothing to disclose

EPR3163

The (Mis-)Perception of Sleep: Factors influencing the discrepancy of subjective vs. objective sleep parameters

K. Trimmel, H.G. Eder, M. Boeck, A. Stefanic, G. Kloesch, S. Seidel

Department of Neurology, Medical University of Vienna, Austria, Vienna, Austria

Background and aims: Subjective perception of sleep often differs from objective measures derived from sleep studies, but factors predicting the discrepancy between subjective and objective sleep parameters are controversial, and a comparison of inpatient vs. ambulatory polysomnography (PSG) is lacking.

Methods: We retrospectively analysed 347 recordings (49% females, median age 48 years) of inpatient (n=258) and outpatient (n=89) PSG conducted between 2012 and 2016. Linear regression was applied to predict the discrepancy of objective and subjective sleep parameters (total sleep time, sleep efficiency, sleep latency), using age, gender, sleep disorder (hypersomnia, parasomnia, sleep-related movement disorders, sleep-related breathing disorders), and PSG type (inpatient vs. outpatient) as regressors.

Results: Sleep disorder was the best predictor of discrepancy between objective and subjective total sleep time (Beta=0.21, $p=0.003$) and sleep efficiency (Beta=0.25, $p<0.001$), independent of age and PSG type ($p>0.05$). Sleep efficiency showed a contributory effect of female gender (Beta=0.15, $p=0.01$). Patients with insomnia showed higher discrepancy of objective vs. subjective sleep parameters compared to all other patient groups (all $p<0.05$). Insomniac patients underestimated both total sleep time (median discrepancy: 46 minutes, $p<0.001$) and sleep efficiency (median discrepancy: 11%, $p<0.001$). No significant predictor for discrepancy of sleep latency was found.

Conclusion: Misperception of sleep duration and efficiency is common in sleep lab patients, but found to be most prominent in patients suffering from insomnia, independent of age, gender, or inpatient vs. ambulatory recording setting. These findings challenge the concept of sole clinical diagnosis of insomnia, and highlight the significance of performing sleep recordings in insomniac patients.

Disclosure: Nothing to disclose

EPR3164

RLS, Insomnia, and OSA in postmenopausal women: the effect on sleep, emotional profile and cognitive functioning

R. Silvestri, E. Vinci, M.C. Di Perri, I. Aricò
Department of Clinical and Experimental Medicine, AOU G Martino, Messina, Italy

Background and aims: Sleep curtailment is linked to cognitive impairment via cerebrovascular alterations or enhanced amyloid deposition, especially in women. Our research aimed to compare the effects of sleep on women's cognitive and emotional profiles in 3 sleep disorders: primary insomnia, obstructive sleep apnea (OSA), and restless leg syndrome (RLS).

Methods: 30 postmenopausal women, 10 per disorder (mean age: 61.00; SD=6.84), completed the Pittsburgh Sleep Quality Index (PSQI), Epworth Sleepiness Scale (ESS), Hamilton Anxiety Rating Scale (HAM-A), Beck Depression Inventory (BDI), cognitive assessment and neuroimaging (CT/MRI). Menopausal onset was comparable among groups (mean age: 48.3; SD=5.05).

Results: ESS was worse in OSA (mean score:12.20) versus insomnia (6) and RLS (9.6). PSQI, BDI, and HAM-A were worse in insomnia versus OSA and RLS. 63.3% of our sample had mild cognitive impairment (MCI): 60% presented vasculopathic changes on MRI/CT, 3.3% brain atrophy. 80% of OSA patients had MCI, of which 70% presented vascular changes, 10% atrophy. 60% of insomniacs and 37.5% of RLS subjects had vascular-related MCI. In all groups, years from menopause-onset positively correlated with PSQI; in OSA also with ESS. ESS correlated with anxiety and depression in RLS and insomnia, only with depression in OSA. MCI correlated with PSQI in RLS and insomnia, and with depression and anxiety in OSA.

Conclusion: Depression, anxiety and poor sleep quality are highly prevalent in all groups. Excessive sleepiness affects only OSA subjects, who also share the highest-burden of MCI. Sleep quality is more altered in insomnia and RLS, correlating with MCI in both groups.

Disclosure: Nothing to disclose

EPR3165

Migraine, Depression, and Sleep-Related Eating Disorder (SRED): gender-related comorbidities of RLS

R. Silvestri, E. Vinci, M.C. Di Perri, A. Bellantone, I. Aricò

Department of Clinical and Experimental Medicine, AOU G Martino, Messina, Italy

Background and aims: Possibly related to a common dopaminergic imbalance, migraine, depression and sleep-related eating disorder (SRED) are often co-morbid to RLS and appear to be more prevalent in women. We aimed to explore the prevalence, features, and impact of these disorders in RLS women versus men.

Methods: 100 consecutive RLS patients, 61 women (mean age: 57.49; SD=12.52) and 39 men (mean age=60.38; SD=9.78), were assessed for RLS family history, comorbidities, RLS severity (IRLS-RS), Beck Depression Inventory (BDI), Eating Disorder Inventory (EDI) on at least two visits: T0 and T1 (6-24 months later).

Results: 44.9% of the female cohort vs. 27.7% men had a positive RLS family history. As far as comorbidities, migraine was present in 30.2% women vs. 5% men, SRED in 25.6% women versus 7.5% men and depression in 43% women versus 38% men. Mere suspension of antidepressants led to full remission of RLS in 44% of our cohort with significant improvement of symptoms. Depression and RLS symptoms were worse in women versus men both at T0 ($p=0.000$, $p=0.003$ respectively) and T1 ($p=0.005$, $p=0.000$ respectively), however, response to therapy (dopaminergic and alfa-2-delta drugs) was better in women (72.8% improvement) versus men (51.8%).

Conclusion: In our cohort, women were prevalent, had more severe RLS with positive family history, a higher burden of comorbidities, but a greater improvement of BDI and RLS symptoms with therapy. RLS proved iatrogenic in 44% of our sample on antidepressants

Disclosure: Nothing to disclose

EPR3166

Circadian phase tailored light therapy in Alzheimer's disease: preliminary findings on sleep and cognition

D. Sparasci¹, R. Cremascoli², G. Giusti¹, M. Picascia³, S. Bernini³, V. Rustioni¹, C. Ghezzi⁴, S. Cerri⁵, M. Terzaghi⁶, E. Sinforiani³, R. Manni⁶

¹Department of Brain and Behavioural Sciences, University of Pavia, Pavia, Italy, ²Pavia, Italy, ³Neuropsychology/Alzheimer's Disease Assessment Unit, IRCCS Mondino Foundation, Pavia, Italy, ⁴Laboratory of Functional Neurochemistry, IRCCS Mondino Foundation, Pavia, Italy, ⁵Functional Neurochemistry Laboratory, IRCCS C. Mondino National Neurological Institute, Pavia, Italy-University of Pavia, Pavia, Italy, ⁶Unit of Sleep Medicine and Epilepsy-Department of Neurosciences, IRCCS C. Mondino National Neurological Institute, Pavia, Italy-University of Pavia, Pavia, Italy

Background and aims: Our study aims to investigate the effects of a tailored light therapy protocol on sleep and cognition parameters in patients with Alzheimer's disease (AD) of mild/moderate severity.

Methods: 20-drug-free, AD patients were consecutively investigated for cognitive and behavioral performances, subjective nocturnal sleep quality, circadian phase and actigraphic sleep parameters before and after a single-blind 4-weeks tailored light therapy versus sham protocol (Luminette glasses with light (10000 lux) 20 minute-exposure). We present preliminary data of 8 patients (M/F: 4/4; mean age 72±5.7 years; mean MMSEc 19.02±2.71) who completed the protocol.

Results: Light therapy induced a circadian phase shift in five patients. The circadian phase was delayed of 171 minutes (Dim Light Melatonin Onset (DLMO) 21:30±0:53) in the 2 early circadian phase (ECPpts; DLMO 18:39±0:32) while it was advanced of 66 minutes in 3 late circadian phase (LCPpts; DLMO 22:21±1:05 vs DLMO 21:15±1:07), unchanged in 1 and unexpectedly delayed in 2. Sleep efficiency did not change in both ECPpts and LCPpts; 24-hour total sleep time increased and sleep quality significantly improved ($p<0.05$) in both subgroups of patients. The cognitive performances in the ECPpts improved after light therapy (MMSEc 18.20±5.94 vs 22.55±0.77) while it remained unchanged in the LCPpts (MMSEc 20.30±3.25 vs 21.04±2.79).

Conclusion: The light therapy protocol tailored on the circadian phase proved to be associated to an objective phase shift, an increase in subjective sleep quality, 24-hour total sleep time and a better cognitive performance in patients with mild/moderate forms of AD.

Disclosure: Nothing to disclose

EPR3167

The Swiss Primary Hypersomnolence and Narcolepsy Cohort Study (SPHYNCS)

A. Dietmann¹, E. Wenz¹, M. Ringli¹, J. Van der Meer¹, E. Edwards¹, M. Schmidt², C.A. Bernasconi¹, A. Nirakko³, M. Strub⁴, S. Miano⁵, M. Manconi⁶, Z. Zhang⁷, C. Largardier⁸, M. Tafti⁹, D. Latorre¹⁰, F. Sallusto¹¹, R. Khatami⁷, C.L. Bassetti¹

¹Department of Neurology, Inselspital, Bern University Hospital and University of Bern, Bern, Switzerland, ²Neurology, Bern University Hospital, Berne, Switzerland, ³Hofklinik für Wach- & Schlafmedizin, Luzern, Switzerland, ⁴Zentrum für Schlafmedizin Basel, Basel, Switzerland, ⁵Sleep and Epilepsy Center, Neurocenter of Southern Switzerland, Civic Hospital of Lugano, Lugano, Switzerland, ⁶Neurocentre of Southern Switzerland, Lugano, Switzerland, ⁷Barmelweid, Switzerland, ⁸Department of Clinical Chemistry, Inselspital, Bern University Hospital and University of Bern, Bern, Switzerland, ⁹Center for Investigation and Research in Sleep, Lausanne, Switzerland, ¹⁰Institute of Microbiology, ETH Zurich, Zurich, Switzerland, ¹¹Institute of Microbiology, ETH Zurich, Zurich and Institute for Research in Biomedicine, Faculty of Biomedical Sciences, USI, Bellinzona, Switzerland, Zurich, Switzerland

Background and aims: Narcolepsy type I (NT1) is a disorder with well established biomarkers and a suspected autoimmune etiology. Conversely, narcolepsy type 2 (NT2) and the narcoleptic borderland (NBL) lack well defined biomarkers and remain controversial in terms of etiology, diagnosis, and management. SPHYNCS is a multicentre cohort study which will study presentation and long-term course, search for new biomarkers and assess the frequency of established biomarkers of NT1, NT2 and NBL.

Methods: 5 swiss sleep centers which belong to the Swiss Narcolepsy Network joined the study (additional 4 may be added soon) will prospectively enroll over 4 years over 300 patients with recent onset of excessive daytime sleepiness (EDS), hypersomnia (H) or a suspected central disorder of hypersomnolence (CDH). Healthy controls (HC) and patients with EDS due to severe sleep related breathing disorder, which is improved after therapy, will represent a control group of over 50 patients.

Results: Clinical, electrophysiological (polysomnography, actigraphy, vigilance tests, longterm monitoring with wearables) and questionnaire information will be collected at baseline and after 6, 12, 24 and 36 months. Potential biomarkers will be searched for in blood, cerebrospinal fluid, and stool. Analyses will include hypocretin measurements, proteomics and peptidomics, immunological, genetic and microbiota studies.

Conclusion: SPHYNCS, which in the near future plans to include also pediatric patients, will increase our understanding of CDH and the relationship between NT1, NT2 and NBL. The identification of new (clinical, neurophysiological, laboratory) biomarkers is expected to lead to better and earlier diagnosis and personalized management of CDH.

Disclosure: Nothing to disclose